

EM 1110-1-1005
1 January 2007

US Army Corps
of Engineers

ENGINEERING AND DESIGN

Control and Topographic Surveying

ENGINEER MANUAL

CECW-CE

Manual
No. 1110-1-1005

1 January 2007

**Engineering and Design
CONTROL AND TOPOGRAPHIC SURVEYING**

Table of Contents

Subject	Paragraph	Page
Chapter 1		
Introduction		
Purpose	1-1	1-1
Applicability	1-2	1-1
Distribution.....	1-3	1-1
References	1-4	1-1
Discussion	1-5	1-1
Use of Manual	1-6	1-2
Scope of Manual.....	1-7	1-2
Life Cycle Project Management Applicability.....	1-8	1-4
Metrics and Accuracy Definitions.....	1-9	1-4
Trade Name Exclusions.....	1-10	1-4
Abbreviations and Terms	1-11	1-4
Mandatory Requirements	1-12	1-4
Governing Engineer Regulations and Related Standards.....	1-13	1-5
Proponency and Waivers.....	1-14	1-5
Chapter 2		
Overview of Topographic Surveying Techniques and Methods		
Purpose	2-1	2-1
General Definitions	2-2	2-1
Generic Considerations Applicable to all Drawings and Maps.....	2-3	2-2
SECTION I--Types of Surveys		
Reconnaissance Topographic Surveys	2-4	2-4
Detailed Topographic Surveys	2-5	2-5
Utility Surveys.....	2-6	2-6
As-Built Surveys	2-7	2-8
Reservation Boundary Surveys and Maps.....	2-8	2-9
Reservoir Clearing Surveys.....	2-9	2-11
Upland Disposal Area Surveys.....	2-10	2-12
Channel Improvement and Cutoff Surveys	2-11	2-12
Post-Flood High Water Mark Surveys	2-12	2-12
Route Surveys.....	2-13	2-13

Subject	Paragraph	Page
Bridge Surveys	2-14	2-14
Artillery Surveys (FM 3-34.331).....	2-15	2-15
Airport Obstruction and NAVAID Surveys (FM 3-34.331)	2-16	2-15
Site Plan Engineering Drawings.....	2-17	2-17
Army Installation Mapping Requirements	2-18	2-18
 SECTION II--Survey Methods and Techniques		
Older Topographic Surveying Methods	2-19	2-21
Total Stations.....	2-20	2-23
Real Time Kinematic (RTK) GPS.....	2-21	2-25
Terrestrial LIDAR (Laser) Scanning.....	2-22	2-26
Topographic Data Collection Procedures.....	2-23	2-26
Automated Field Data Collection.....	2-24	2-28
Methods of Delineating and Densifying Topographic Features.....	2-25	2-29
General QC and QA Guidance on Topographic Data Collection and Drawings	2-26	2-38

Chapter 3
Primary Control Surveys for Project Mapping

Purpose and Scope.....	3-1	3-1
 SECTION I--Traditional Horizontal Control Survey Techniques		
General Overview.....	3-2	3-2
Secondary or Temporary Horizontal Control.....	3-3	3-7
Bearing and Azimuth Determination.....	3-4	3-8
Electronic Distance Measurement.....	3-5	3-10
Coordinate Computations.....	3-6	3-12
Traverse Surveys	3-7	3-14
Traverse Survey Guidelines	3-8	3-16
Traverse Computations and Adjustments.....	3-9	3-17
Traverse Adjustment (Compass Rule).....	3-10	3-19
Triangulation and Trilateration Surveys.....	3-11	3-21
 SECTION II--Vertical Control Survey Techniques		
General	3-12	3-23
Second-Order Leveling	3-13	3-28
Third-Order and Lower-Order Leveling.....	3-14	3-32
Calibrations and Adjustments.....	3-15	3-37
Care of Level Instruments	3-16	3-39
Routine Maintenance and Care of Level Rods.....	3-17	3-41
Maintenance of Survey Instrument Accessories	3-18	3-42

Chapter 4
Accuracy Standards for Engineering, Construction, and Facility Management Control and Topographic Surveys

Purpose	4-1	4-1
General Surveying and Mapping Specifications	4-2	4-1
Accuracy Standards for Engineering and Construction Surveying.....	4-3	4-2

Subject	Paragraph	Page
Accuracy Standards for Maps and Related Geospatial Products.....	4-4	4-5
Photogrammetric Mapping Standards and Specifications.....	4-5	4-10
Cadastral or Real Property Survey Accuracy Standards	4-6	4-10
Hydrographic Surveying Accuracy Standards	4-7	4-13
Structural Deformation Survey Standards.....	4-8	4-13
Geodetic Control Survey Standards	4-9	4-13
State and Local Accuracy Standards	4-10	4-15
CADD/GIS Technology Center Standards.....	4-11	4-19
Mandatory Standards.....	4-12	4-19

Chapter 5
Geodetic Reference Datums and Local Coordinate Systems

Purpose and Background.....	5-1	5-1
 SECTION I--Geodetic Reference Systems		
General	5-2	5-2
Geodetic Coordinates	5-3	5-2
Datums.....	5-4	5-4
WGS 84 Reference Ellipsoid.....	5-5	5-5
Horizontal Datums and Reference Frames.....	5-6	5-6
 SECTION II--Horizontal Coordinate Systems		
General	5-7	5-10
Geographic Coordinates	5-8	5-10
State Plane Coordinate Systems	5-9	5-10
Grid Elevations, Scale Factors, and Convergence.....	5-10	5-14
Universal Transverse Mercator Coordinate System.....	5-11	5-15
The US Military Grid-Reference System (FM 3-34.331)	5-12	5-15
US National Grid System	5-13	5-16
Chainage-Offset Coordinate Systems	5-14	5-17
Datum Conversions and Transformation Methods.....	5-15	5-19
Horizontal Transition Plan from NAD 27 to NAD 83	5-16	5-22
 SECTION III--Vertical Reference Systems		
National Geodetic Vertical Datum of 1929 (NGVD 29).....	5-17	5-25
North American Vertical Datum of 1988 (NAVD 88).....	5-18	5-25
Other Vertical Reference Datums and Planes	5-19	5-26
Orthometric Elevations.....	5-20	5-27
WGS 84 Ellipsoidal Heights	5-21	5-28
Orthometric Height and WGS 84 Ellipsoidal Elevation Relationship	5-22	5-29
Geoid Undulations and Geoid Models	5-23	5-30
Using GPS to Densify Orthometric Elevations	5-24	5-30
Vertical Datum Transformations.....	5-25	5-31
Vertical Transition Plan from NGVD 29 to NAVD 88.....	5-26	5-32
Vertical Control in Areas Subjected to Subsidence or Sea Level Rise	5-27	5-33
Mandatory Standards.....	5-28	5-35

Subject	Paragraph	Page
---------	-----------	------

Chapter 6
Planning and Conducting Control and Topographic Surveys

Purpose	6-1	6-1
Project Requirements from Using Agency	6-2	6-1
Topographic Survey Planning Checklist	6-3	6-4
Rights-of-Entry	6-4	6-7
Sources of Existing Geospatial/Survey Data	6-5	6-8
Project Control for Topographic Detail Surveys	6-6	6-9
Establishing NSRS Control at a Project Site	6-7	6-12
Project Control Densification Methods	6-8	6-12
Extending Control from a Local Project or Installation Network (Patrick AFB).....	6-9	6-13
Extending Control from a Distant Network Using		
Continuously Operating Reference Stations (CORS).....	6-10	6-15
On-Line Positioning User Service (OPUS)	6-11	6-21
Establishing Approximate Control for an Isolated		
or OCONUS Construction Project	6-12	6-21
Determining Required Map Scale and Contour Interval	6-13	6-22
Recommended Guidelines for Army Installation Maps and Drawings.....	6-14	6-30
Topographic Survey Equipment Selection and Planning Guidance.....	6-15	6-37

Chapter 7
Field Data Collectors and Coordinate Geometry Functions

Purpose	7-1	7-1
Field Survey Notes--Manual and Electronic	7-2	7-1
Functional Requirements of a Generic Data Collector	7-3	7-4
General Software Features on a Data Collector	7-4	7-5
Feature or Descriptor Codes for Topographic Field Data	7-5	7-6
Descriptor Codes and Level Assignments for Various Topographic Features.....	7-6	7-10
Feature and Attribute Libraries for Topographic Field Data.....	7-7	7-18
Control Commands for Connecting Feature Line Strings	7-8	7-20
Field Coordinate Geometry Options	7-9	7-21
General COGO Computation Routines	7-10	7-22
Total Station Resection Computations	7-11	7-24
Line-Line Intersection Computations.....	7-12	7-26

Chapter 8
Total Station Topographic Survey Procedures

Purpose	8-1	8-1
Total Stations.....	8-2	8-1
Total Station Features and Operation	8-3	8-3
Reflectorless and Robotic Total Stations.....	8-4	8-5
Field Equipment Inventory and Maintenance	8-5	8-6

Subject	Paragraph	Page
Total Station Job Planning.....	8-6	8-8
Total Station Error Sources	8-7	8-9
General Total Station Operating Procedures	8-8	8-12
Total Station Angle Measurement and Traverse Techniques.....	8-9	8-14
Total Station Leveling Field Procedures	8-10	8-14
Positioning Topographic Features with a Total Station	8-11	8-17

Chapter 9
GPS Real Time Kinematic Topographic Survey Procedures

Purpose and Scope.....	9-1	9-1
RTK Field Techniques	9-2	9-2
Standard RTK Observing Procedures	9-3	9-5
Site Calibration.....	9-4	9-7
RTK Survey Field Data Collection Procedures and Checks	9-5	9-10
Guidance for Setting Construction Control Points Using RTK Techniques	9-6	9-12

Chapter 10
Terrestrial 3D Laser Scanners

Purpose	10-1	10-1
Background	10-2	10-1
Scanner Operation and Data Processing.....	10-3	10-4
Corps of Engineers Project Application:		
St. Lucie Lock and Dam, Jacksonville District	10-4	10-6
Corps of Engineers Project Application:		
Portuguese Dam Foundation Construction, Ponce, PR, Jacksonville District ...	10-5	10-8
Corps of Engineers Application:		
Steel Bayou Levee Surveys, Vicksburg District	10-6	10-10
Corps of Engineers Application:		
Structure Subsidence Survey, Philadelphia District	10-7	10-12

Chapter 11
Final Site Plan or Map Production

Purpose	11-1	11-1
Overview of Topographic Survey Data Flow.....	11-2	11-1
Basic Definitions of Geospatial Data used in CADD or GIS Databases.....	11-3	11-3
SDSFIE Data Model.....	11-4	11-7
Data Collection and Processing Procedures for Topographic Surveys	11-5	11-8
Field Computers and Software for Viewing and Processing Data	11-6	11-9
Field Quality Control and Quality Assurance Checks.....	11-7	11-11
Cell Libraries Containing Corps of Engineers Standardized Symbolology	11-8	11-13
Sheet and Model Files	11-9	11-14
Reference Files	11-10	11-14
Level Assignments for Surveying and Mapping	11-11	11-15

Subject **Paragraph** **Page**

Chapter 12
Survey Documentation and Submittals

General	12-1	12-1
Final Survey Report Format--Civil Works	12-2	12-1
Final Survey Report Format--Military	12-3	12-2
Field Note Keeping Procedures and Formats	12-4	12-3
Sample Topographic Survey Field Book Notes	12-5	12-6
Monument Descriptions	12-6	12-10
Standardized Coordinate File Coding (New Orleans District)	12-7	12-11
Creating Metadata for Topographic Surveys.....	12-8	12-16
Sample Submittal of Feature Data Accuracy	12-9	12-21
Deliverable QA Checklist.....	12-10	12-22
Mandatory Criteria	12-11	12-22

Chapter 13
Topographic Survey Contracting and Cost Estimating

General Contracting Policies and Procedures	13-1	13-1
Indefinite Delivery Contracts	13-2	13-3
Cost Estimates for Contracted Topographic Mapping IDCs	13-3	13-6
Task Order Time and Cost Estimates	13-4	13-9
Task Order Request for Proposal	13-5	13-11
Government Cost Estimate for a Task Order	13-6	13-15
AE Services Request for Task Order Issuance	13-7	13-17
Labor Hour Task Orders for Construction Surveying Services.....	13-8	13-18
Hired-Labor Survey Cost Estimates	13-9	13-20

Subject	Paragraph/ Page
Appendix A References	A-1
Appendix B Requirements and Procedures for Referencing Coastal Navigation Projects to Mean Lower Low Water (MLLW) Datum	B-1
Appendix C Development and Implementation of NAVD 88	C-1
Appendix D Sample Scopes of Work and Guide Specifications for Topographic Surveying Services	D-1
Appendix E Application: Topographic Survey of Beach Sections Adjacent to Tillamook North Jetty, Oregon (Portland District)	E-1
Appendix F Application: Topographic Survey for Relocation of Red Feather Prairie Bike Trail, Saylorville Lake Project, Iowa (Rock Island District)	F-1
Appendix G Application: Topographic Survey of Hannibal Lock & Dam, Proposed Nationwide DGPS Antenna Site (Pittsburgh District)	G-1
Appendix H Application: Topographic and Planimetric Survey--Proposed Military Fitness Center (Tulsa District)	H-1
Appendix I Application: Control and Topographic Surveys Vicinity Footbridge at Willamette Mission Bottom, Oregon (Portland District)	I-1
Appendix J Application: Topographic Survey for Proposed US Army Reserve Center Belaire, Belmont County, Ohio (Louisville District)	J-1
Appendix K Application: Topographic and Boundary Surveys, Bayou Baton Rouge Drop Structure, Amite River and Tributaries, Comite River Diversion Project, East Baton Rouge Parish, Louisiana (New Orleans District)	K-1
Appendix L Glossary	L-1

Chapter 1 Introduction

1-1. Purpose

This manual provides guidance on performing detailed site surveys of military installation facilities and civil works projects. Technical specifications, procedural guidance, and quality control criteria are outlined for developing large-scale site plans used for engineering drawings of planned projects, or detailed as-built feature mapping of completed facilities.

1-2. Applicability

This manual applies to all USACE commands having responsibility for the planning, engineering and design, operation, maintenance, construction, and related real estate and regulatory functions of military construction, civil works, and environmental restoration projects. It is intended for use by hired-labor personnel, construction contractors, and Architect-Engineer (A-E) contractors. It is also applicable to surveys performed or procured by local interest groups under various cooperative or cost-sharing agreements.

1-3. Distribution

This publication is approved for public release; distribution is unlimited.

1-4. References

Referenced USACE publications and related bibliographic information are listed in Appendix A. Where applicable, primary source material for individual chapters may also be noted within that chapter.

1-5. Discussion

Control and topographic surveys are performed to determine the planimetric location and/or elevation of surface or subsurface features, facilities, or utilities. These surveys are normally used to prepare highly detailed site plan maps (and digital databases) of a project site, facilities, or utility infrastructure; for future design, on going construction, or as-built condition. Engineering drawing scales are typically large--ranging between 1 inch = 30 ft and 1 inch = 100 ft. These surveys are performed over relatively small project sites using tripod-mounted, manually operated, terrestrial survey equipment, such as transits, tapes, levels, plane tables, electronic total stations, and GPS receivers. This manual covers the field survey techniques, instrumentation, and electronic data collection systems that are used in performing these ground-based field surveys, and transferring observed data into facility management or design databases. Also included are methods for extending geodetic control needed for supplemental topographic mapping work on a military installation or civil works project site. This manual also includes procedures for transferring field data to computer-aided drafting and design (CADD) systems or geographic information systems (GIS) used in planning, engineering, construction, and facility management. Aerial topographic mapping techniques are not addressed in this manual-- see EM 1110-1-1003 (*Photogrammetric Mapping*). FM 3-34.331 (*Topographic Surveying*) should be consulted for tactical field surveying operations supporting field artillery (FA), air-defense artillery (ADA), aviation (e.g., airfield NAVAID and obstruction surveys), intelligence, communications, or construction.

Chapter 2 Overview of Topographic Surveying Techniques and Methods

2-1. Purpose

This chapter provides an overview of the types of surveys and equipment that are used for performing control and topographic surveys. It covers the various types of engineering surveys used to support facility design and construction, the different survey equipment and instruments, and the general field and office procedures that are performed.



Figure 2-1. Topographic survey at Prompton Dam, PA
(Philadelphia District--April 2005)

2-2. General Definitions

“Topographic surveying” encompasses a broad range of surveying and mapping products, ranging from aerial mapping to ground and underground surveys. “Control surveying” likewise can cover wide area geodetic surveys to construction stakeout. The following definitions from the Florida Administrative Code (FAC 2003) illustrates how topographic and control surveying falls under the overall “surveying and mapping” field:

“Surveying and Mapping: a process of direct measurement and analysis specifically designed to document the existence, the identity, the location, and the dimension or size of natural or artificial features on land or in the air, space or water for the purpose of producing accurate and reliable maps, suitable for visualization if needed, of such documentation.”

“Topographic Survey: a survey of selected natural and artificial features of a part of the earth’s surface to determine horizontal and vertical spatial relations.”

“Control Survey: a survey which provides horizontal or vertical position data for the support or control of subordinate surveys or for mapping.”

Anderson and Mikhail 1998 define topographic surveys as follows:

“A topographic map shows, through the use of suitable symbols, (1) the spatial characteristics of the earth’s surface, with such features as hills and valleys, vegetation and rivers, and (2) constructed features such as buildings, roads, canals, and cultivation. The distinguishing characteristic of a topographic map, as compared with other maps, is the representation of the terrain relief.”

As outlined in the scope in Chapter 1, the guidance and instructions in this manual will focus on the performance of site plan surveys required for the design and construction of military facilities and civil works projects. Control survey methods will focus on those surveys required to support detailed site mapping. ERDC/ITL 1999b defines installation map products as:

"Maps are tools that provide the commanders with timely, complete, and accurate information about our installation. They have three primary uses on the installation: locate places and features, show patterns of distribution (natural and physical phenomena), and compare and contrast map information by visualizing the relationships between these phenomena. A map is a representation of reality comprised of selected features needed to meet the maps intended purpose."

2-3. Generic Considerations Applicable to all Drawings and Maps

There are some differences between topographic maps and plans (or engineering drawings). In general, maps are usually developed at a smaller scale, whereas detailed site plan drawings are at much larger scales. The following table (from Kavanagh 1997) illustrates this distinction:

Table 2-1. Map Scales Used for Various Engineering Drawings

<u>Scale</u>	<u>Typical Uses</u>
1" = 1' to 1" = 8'	Large scale detail drawings, architectural plans
1" = 20' -30'- 50' to 1" = 100'	Engineering site plans, facility design
1" = 100' to 1" = 800'	Intermediate scale: planning studies, drainage, route planning
1" = 1,000' and smaller	Small scale: topographic maps, USGS quad maps, NOAA charts

In general, map scales greater than 1 inch = 100 ft are intended for detailed design purposes. Smaller scales between than 1 inch = 100 ft and 1 inch = 1,000 ft are used for general planning purposes. To assure convenience of use and to derive full benefit from maps and plans, the data on various types of the above project drawings should contain the following criteria:

a. State Plane Coordinate System. It is desirable that the surveys and construction drawings for different projects be correlated with each other and with other Federal agencies. This is accomplished by the use of the State Plane Coordinate System as the coordinate system of the project, and insuring that this grid reference is adequately tied in to a nationwide geodetic reference system. In some cases, an arbitrary or artificial coordinate system may be used.

b. Coordinate grid lines. To enable proper correlation between the various project maps and plans, there must be drawn on all project maps (or CADD sheet files) the coordinate grid lines of the project coordinate system. These lines should be spaced five (5) inches apart; the outside coordinate lines should be the match lines for adjacent map sheets.

c. Determination of plan scales. The scale of topographic maps should be chosen so that these maps may serve as base maps over which subsequent project drawings can be drawn at the same scale. Reference Table 6-1 for guidance on selecting map scales. Thus, the scale of a reconnaissance topographic survey is chosen at a convenient scale so that it may serve as base over which the preliminary site studies and approved site plan may be prepared. The detailed topographic maps will also serve as a base upon which to prepare detailed utility maps.

d. Outside sources of information. Full use should be made of surveying and mapping information available in the various Federal, state, local agencies, and geospatial data clearinghouses prescribed in Corps regulations. USACE Commands are required by ER 1110-1-8156 to perform clearinghouse searches.

e. Accuracy. The type of survey, map scale, and contour interval should be selected in each case to interpret the character of the terrain most suitably for the purpose, and the tolerance of permissible error should be prescribed in each instance. It is not necessary that reconnaissance topographic surveys be of the same degree of accuracy as detailed topographic surveys, nor should they show the topographic data with the same degree of detail.

f. Control to be shown on Plans. The coordinate grid, horizontal control stations, benchmarks, and related reference datums should be shown on all maps and plans--see Chapter 5 for specific details. This is of particular importance in detailed layout plans of building areas drawn at the larger scales of 1 inch = 100 ft or 1 inch = 50 ft. The data are vital to speed and accuracy in subsequent location survey work.

SECTION I Types of Surveys

The following types of products are covered by this manual, all of which are assumed to fall under the broad definition of “topographic surveying”:

- Reconnaissance Topographic Surveys
- Detailed Topographic Surveys and Maps
- Utility Surveys and Maps
- As-built Drawings
- Boundary Surveys and Reservation Maps
- Reservoir Clearing Surveys
- Upland Disposal Area Surveys
- Channel Improvement and Cutoff Surveys
- Post-Flood High Water Mark Surveys
- Bridge Surveys
- Artillery Surveys
- Airport Obstruction and NAVAID Surveys
- Site Plans (Hydrographic, Beach, Levee, Route, Quantity, Structure, etc.)
- Army Installation Drawings

Some of the above surveying and mapping applications will overlap in practice and definitions will vary from District to District. Aerial topographic mapping products are excluded from this manual, as are high-order geodetic control surveys.

2-4. Reconnaissance Topographic Surveys

Topographic surveys have various definitions by different agencies and publications. These may include everything from photogrammetric mapping to hydrographic surveys. The reconnaissance topographic surveys described below relate to smaller scale preliminary mapping performed in advance of engineering and design, and are often called preliminary surveys. Following are the important considerations in connection with reconnaissance topographic surveys:

a. Purpose of reconnaissance surveys. The reconnaissance survey is the basis for a general study or a decision as to the construction suitability of areas. It may also be used for preliminary site layouts. Reconnaissance surveys are useful in showing the general location of roads, building areas, and utilities; and to establish an acceptable site layout which must be approved by authorized officers before detailed layout plans can be made. Such surveys also enable the proper selection of those areas, relatively limited in extent, which should be covered by the more time-consuming and costly detailed topographic surveys. In some instances the US Geological Survey (USGS) topographic quadrangle sheets may be enlarged and used for this purpose. The success of such use will be dependent upon the contour interval, whether the USGS maps are of recent date, the character of the terrain, and the nature of the project.

b. Map scales and contour intervals. Dependent upon the size and shape of the area and upon the nature of the terrain, i.e., density of culture and steepness of slope, reconnaissance surveys may be at scales varying from 1 inch = 400 ft to 1 inch = 1,000 ft. In cases where the project is of limited size, a scale of 1 inch = 200 ft may be used. Contour intervals of either five feet or ten feet may be used. The five-foot interval is the more serviceable and should be used except where steepness of slope makes the ten-foot interval advisable. When areas contain both flat and very steep slopes a ten-foot interval may be adopted as the contour interval of the map. On the flat areas, one-half interval contour (e.g., five foot)

may be shown, discontinuing them wherever the slopes become steep or uniform. Contours having different intervals should not be shown by the same symbol on the same map. In extremely flat areas, a one- or two-foot contour interval may be required to adequately represent the terrain.

c. Accuracy and degree of detail. Extreme accuracy of position is not necessary and minutiae of detail are not desirable. The map should show all pertinent physical features such as roads, railroads, streams, cleared and wooded areas, houses, bridges, cemeteries, orchards, lakes, ponds, and fence lines. Elevations should be shown by contours and spot elevations at road intersections, bridges, water surfaces, tops of summits and bottoms of depressions.

d. Datum. When practical and feasible, it is desirable for these surveys to be referenced to an established NSRS datum, rather than some arbitrary grid system.

2-5. Detailed Topographic Surveys

Following are the important considerations in connection with detailed topographic surveys. Further guidance is contained in Chapter 6.

a. Purpose of detailed topographic surveys. Detailed topographic surveys are the basis for detailed plans showing the site layout and utilities. The area to be covered by detailed surveys should be kept to a minimum to serve the requirements of the actual building area and should not be made where reconnaissance surveys will serve. Detailed topographic surveys may be made by plane table, total station, GPS, laser scanning, and/or photogrammetry.

b. Map scales and contour intervals. Detailed topographic surveys should be at a map scale of 1 inch = 100 ft or 1 inch = 200 ft, with contour intervals of two feet, depending on the convenient size to be established for detailed site plans and utility maps. A scale of 1 inch = 50 ft is also used on small projects.

c. Accuracy and degree of detail. Upon the map sheets there shall be shown all control points and bench marks with their designating numbers and their elevations, all roads, railroads, streams, fence lines, utilities, poles, isolated trees ten inches or more in diameter, boundaries of timbered areas rock ledges or boulders, wells, buildings, cemeteries and any other physical data that will affect planning. In addition to elevations shown by the contours, there should be shown spot elevations at all summits, bottoms of depressions, tops of banks, stream or water surfaces, roads and railroad lines at breaks of grade, intersections, bridges, bases of isolated trees, first-floor elevation of existing buildings, and ground surfaces at wells. The contours should faithfully express the relief detail and topographic shapes. Accuracy standards for topographic mapping features are detailed in Chapter 4.

d. Horizontal control. There should be established a system of monumented horizontal control originating from and closing upon existing NSRS control points. Since this control should also serve the needs of subsequent site layouts and utility maps, the selection of its position and frequency must give due weight to these needs. In areas where there is to be intensive development, the lines of control circuits should ideally not be more than 2,000 to 2,500 feet apart in one direction, but may be of any convenient dimension in the other direction. Control points should generally not be more than 800 to 1000 feet apart along the line of the circuit and should be intervisible. In order to serve property survey needs, the outside control circuits should have control points within 300 or 400 feet of probable property boundary corners. Where topography is to be taken by plane table, a sheet layout should first be made and the control circuits selected near two sheet borders so that the line may be platted on both sheets.

e. Vertical control. Vertical control should consist of levels run in circuits originating from and closing upon Federal Government benchmarks. The closure error of these circuits should be predicated on the character and scope of construction involved. The elevation of each traverse station monument should be determined. Other permanent benchmarks as deemed necessary should be set.

f. Reference datum. When practical and feasible, it is desirable for these surveys to be referenced to an established NSRS datum, rather than some arbitrary grid or vertical reference system.

2-6. Utility Surveys

There are several kinds of utility surveys, but principally they can be divided into two major types. One type is performed for the layout of new systems, and the other is the location of existing systems. Typical utilities that are located include communications lines, electrical lines, and buried pipe systems including gas, sewers, and water lines. The layout of new systems can be described as a specialized type of route surveying, in that they have alignment and profiles and rights-of-ways similar to roads, railroads, canals, etc. In reality, utilities are transportation systems in their own right. Utilities are special in that they may have problems regarding right-of-way above or below ground. A great portion of utility surveying involves the location of existing utilities for construction planning, facility alteration, road relocations, and other similar projects. This is a very important part of the preliminary surveys necessary for most of these projects.

a. Purpose of utility maps. To a greater degree than any other drawings prepared in the field, utility maps serve two main purposes: (1) as construction drawings, and (2) as permanent record of the utilities, i.e. "as built." Their value to the Facility or Public Works Engineer in the proper operation and maintenance of the project is such as to require complete information on all pertinent features of each utility. For the purpose of recording "as built" construction in the most readily usable form, two sets of utility maps are usually found most practicable: General Utility Maps at small scale (1 inch = 400 ft or 1 inch = 200 ft and Detailed Utility Maps (sometimes referred to as unit layout maps) at a larger scale (1 inch = 100 ft or 1 inch = 50 ft) as described below.

b. General survey procedure. Utilities are usually located for record by tying in their location to a baseline or control traverse. It may be more convenient to locate them with relation to an existing structure, perhaps the one that they serve.

(1) Aboveground utilities are usually easily spotted and are easier to locate than the subsurface variety. Therefore, they should present little difficulty in being tied to existing surveys. Pole lines are easy to spot and tie in. Consulting with local utility companies before the survey has begun will save much work in the end. Any plats, plans, maps, and diagrams that can be assembled will make the work easier. If all else fails, the memory of a resident or nearby interested party can be of great help.

(2) Proper identification of utilities sometimes takes an expert, particularly regarding buried pipes. There are many types of wire lines on poles and in below ground conduits--this can lead to identification problems. Where once only power and telephone lines were of concern, now cable TV, burglar alarms, and even other wire or fiber optic line types must be considered.

(3) The location of underground utilities by digging, drilling, or probing should be undertaken only as a last resort, and then only with the approval and supervision of the company involved. Some techniques that work are the use of a magnetic locator, ground penetrating radar, a dip needle, or even "witching" for pipes or lines underground.

c. *General utility maps.* At a scale of 1 inch = 400 ft, 1 inch = 300 ft, or on smaller projects at scales of 1 inch = 200 ft, the principal features of each utility are generally shown separately, each utility on a separate map, or CADD layer/level. As a base upon which to add the data for each utility it is normally most convenient to use the approved general site plan of the same scale. The amount of detail to be indicated on each general utility map should be limited to that consistent with the scale of the map. It is usually feasible, even at a scale of 1 inch = 400 ft, to indicate the location, material, pipe sizes, etc., of the main distribution and collection systems, leaving minor construction features (valves, service connections, etc.) to be shown at larger scale on the second set of maps (see Detailed Utility Maps below) or as attributes in a CADD facilities database. General Utility Maps will normally include the following:

- Water Distribution System.
- Sewers: Sanitary and Storm Water Collection Systems
- Electric Distribution System, including Fire Alarm System.
- Communication Systems (telephone, cable, computer, fiber optic, etc.)
- Gas System.
- Gasoline Storage and Fuel System.
- Steam distribution and domestic hot water system for hospitals and other areas. (Include compressed air system, if any)
 - Target and Magazine Areas. (Where located at some distance from the general construction area, these may be shown on a separate map annotated to show the relation to the project)
 - Rail Facilities, including access to serving railroad (unless shown in complete detail on site plans)

Figure 2-2 below is a typical CADD file showing a variety of different utility systems surveyed by Louisville District personnel at an Army Reserve Center. Each utility was coded in the field and placed on a separate MicroStation design file "level." Normally, as shown below, each utility system is given a different color coding as well as a different level assignment. Turning off different utility levels (and assigning these levels to separate sheets) eliminates the apparent overprinting below.

d. *Detailed utility maps (sometimes referred to as Unit Layout Maps).* At a scale of 1 inch = 100 ft or 1 inch = 50 ft and normally on reproductions of the detailed site plans, the detailed utility maps for large or complicated projects are generally prepared showing the details of all utilities on each sheet rather than with each utility on a separate sheet. By this means, the Facility Engineer is informed as to the underground relationship of the various utilities; and avoids the danger, in repairing one utility, of damaging another. Even at the relatively large scale of 1 inch = 50 ft, the complexity of utility data at "busy" intersections may require that inserts be added to the map at still larger scale. The detailed utility maps will show the additional detailed data of all kinds which it was not feasible to show on the smaller-scale general utility maps (grades at ground and inverts of manholes, etc., location and sizes of valves, service connections, etc.) and will thus provide the Facility Engineer with complete data necessary for operation and maintenance. On small projects where it has been feasible to prepare the general utility maps at large scale (1 inch = 50 ft), it will be possible to add the necessary complete detailed utility data to these maps and thus to avoid the preparation of special detailed utility maps. They may also be omitted in cases where it is found feasible to show utility details on "strip" road plans, providing the strips are of sufficient width to show service connections to structures on both sides of the road.

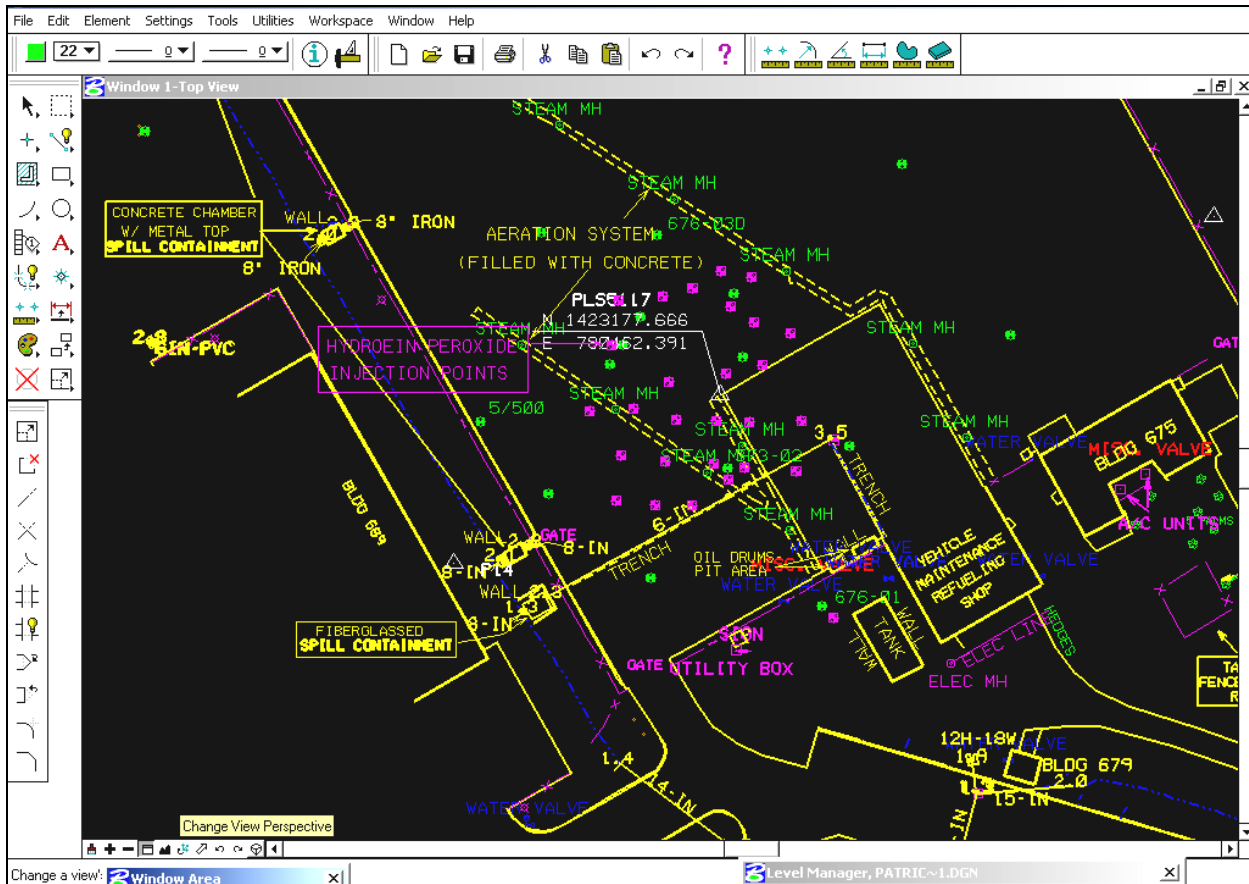

Figure 2-2. Utilities near a Vehicle Maintenance Refueling Facility at Patrick Air Force Base, Florida (Louisville District--2004)

2-7. As-Built Surveys

a. Purpose. As-built surveys are surveys compiled to show actual condition of completed projects as they exist for record purposes and/or payment. Since many field changes occur during construction, both authorized and clandestine, surveys are regularly completed to check the project against plans and specifications. As-built surveys are usually a modified version of the site plans that were originally required to plan the project. This is particularly true of road, railroad, or watercourse relocation projects. These projects are all of the route survey nature. The as-built survey, out of necessity, is this type also. Typical items checked are:

- Alignment.
- Profile or grade.
- Location of drainage structures.
- Correct dimensions of structures.
- Orientation of features.
- Earthwork quantities (occasionally).

b. Methodology. For route-survey-type projects a traverse is usually run and major features of the curve alignment are checked. Profiles may be run with particular attention paid to sags on paved roads or other areas where exact grades are critical. Major features of road projects that are often changed in the field and will require close attention are drainage structures. It is not uncommon for quickly changing

streams to require modification of culvert design. Therefore, culvert and pipe checks are critical. Items that should be checked for all major drainage structures are:

- Size (culverts may not be square).
- Skew angle (several systems in use).
- Type or nomenclature (possibly changed from plans).
- Flow line elevations are very important and should be accurately checked.
- Station location of structure centerline with regard to traverse line should be carefully noted.

(1) Utilities that have been relocated should be carefully checked for compliance with plans and specifications. Incorrect identification of various pipes, tiles, and tubes can result in difficulties. Since the subject is somewhat complicated it is important to keep track of this type of information for the future.

(2) Project monumentation is sometimes a requirement of as-built surveys since it is common to monument traverse lines and baselines for major projects. Their location should be checked for accuracy. In many areas it is common for such monumentation to be done by maintenance people who are not at all familiar with surveying and therefore the work is not always as accurate as would be desired.

2-8. Reservation Boundary Surveys and Maps

a. Purpose. Boundary surveys of civil and military reservations, posts, bases, etc. should generally be performed by a professional land surveyor licensed in the state where the work is performed. Corps of Engineers boundary survey requirements and procedures are detailed in Chapter 3 (Mapping) of ER 405-1-12 (*Real Estate Handbook*). This chapter in ER 405-1-12 describes the procedures for providing maps, surveys, legal descriptions, and related material on a project or installation basis for planning, acquisition, management, disposal, and audit of lands and interests in lands acquired by the Corps of Engineers for Department of the Army military and civil works projects, for the Department of the Air Force, and as agent for other Federal agencies. The criteria, general format, forms development, approval authority, maintenance, and distribution of project maps reflecting graphic depiction of all lands acquired and disposed of are described in this regulation. Boundary surveys include parcel maps, subdivision maps, plats, and any other surveys that are officially recorded (filed) in a local County or State clerk's office. The following are the important considerations regarding boundary surveys:

b. Method and accuracy. The determination of the position of all points should be by transit or total station traverses originating from and closing upon points of the local horizontal control system. The error of survey as indicated by any such closure before adjustment should not exceed the standards specified for boundary surveys in the particular state--usually ranging from 1 part in 5,000 to 1 part in 10,000. Where applicable, procedures and standards in the "*Manual of Instruction for the Survey of the Public Lands of the United States*" (US Bureau of Land Management 1973) should be followed.

c. Reconciliation of conflicting data. Cases occur in which the data supplied by the field surveys do not agree with the deed description; where these conflict and cannot be reconciled legal advice may be necessary. However, it is a generally-accepted rule that where discrepancies exist between the boundary line, as described in the deed, and the boundary lines of possession as defined on the ground by physical objects such as fences, marked trees, boundary stones, boundary roads, and streams, the physical evidence should be held as correct, unless convincing evidence to the contrary is produced.

d. Boundary monuments. When boundary surveys are authorized, standard reinforced concrete monuments should be placed at all angle points on the exterior boundary. In long courses, such monuments should be placed along the line of intervals of 1,000 ft on level terrain and at prominent

points (intervisible if possible) where the terrain is rolling. Where a monument replaces an old landmark it should be clearly so noted in the notes of the survey and on the property map. The notes should fully describe old monuments or landmarks. Monumentation guidance is contained in EM 1110-1-1002 (*Survey Markers and Monumentation*) and in ER 405-1-12 (*Real Estate Handbook*).

e. Scales and other details. Boundary maps may be platted at any convenient scale consistent with the size of the area involved. In the case of small projects the scale of the site plan will be a convenient one for the boundary map. These maps should show the bearings, referred to the meridian of the Government control point to which the survey is tied, and the lengths of property lines and rights-of-way, the names of property owners, and the acreage to the nearest one-hundredth of an acre. Where survey bearings and lengths differ from the deed description the latter should also be shown. The maps should also show the position of all old property marks or corners that were found. The project coordinate grid lines, control points, and the coordinate values of the beginning corner of the survey (POB) should be shown on the maps.

f. Metes and bounds description. A complete typewritten metes and bounds description will be prepared and will include the bearings and distances of all courses of the exterior boundary of the reservation including detached areas, if such exist, with type of markers placed at angle and intermediate points. The description will state the acreage, the county and state within which the area is situated, and the date of the survey. The description should also include metes and bounds of any excepted area within the reservation such as roads, railroads, and easements, with areas thereof.

g. Reservation maps. Reservation maps are required wherever the entire area of a reservation, or portion thereof, is held in fee title by the Government. The scale of the reservation map will depend upon the area involved, reliable information available, and on the scale of reservation maps in existence. Until such time as the boundary surveying and monumenting of properties acquired by purchase or condemnation are authorized, reservation maps will be usually comprised of a compilation of all available existing information in the form of deed descriptions, General Land Office survey data, metes and bounds descriptions if available, etc. The following data will be clearly set forth on the reservation map:

- All exterior boundary lines (based on certified and monumented surveys if prepared).
- Total acreage (computed, if a survey has been authorized), together with acreage of lands transferred by temporary agreement, if any.
 - The exterior boundaries and acreage of all additions to existing military areas acquired since preparation of earlier reservation maps--to be indicated on original maps of the reservation if practicable, otherwise on segmental maps properly coordinated with the original maps.
 - The metes and bounds survey description, if previously authorized, or the General Land Office survey description, if available.
 - The approximate outline and designation of all outstanding areas of operation which are a part of the military reservation; for example, Cantonment Areas, Ordnance Areas, Airfield and Revetment Areas, Hospital Areas, Maneuver Areas, Depot Areas, Radio Sites, Target Range Areas, Bombing Areas, and other areas of importance.
 - Rights-of-way for sewerage, water supply lines, and other utility rights-of-way. If prepared on segmental maps, these should be properly coordinated with the reservation map.
 - The State and County or Counties within which the reservation is located.

2-9. Reservoir Clearing Surveys

a. Purpose. Reservoir clearing surveys will include the establishment and mapping of the upper clearing limit, the marking of pertinent portions of dredging spoil areas, the location of clearing and grubbing limits for channel cut offs and improvements, and the lay out and marking of boat channels through areas which will not be cleared. The upper clearing limit comprises the major portion of the job, and work on this item should be vigorously prosecuted most particularly during the winter months while the foliage is off the trees. The clearing limit contour will be established on the ground, painted, staked, and mapped for all parts of the reservoir except such areas as may be prescribed to leave nucleated. The following are typical examples:

- Areas for the enhancement of game and fish habitat.
- Upstream limits of creeks where pool is confined within the old channel or within steep banks.
- Within the river banks except for designated sections where clearing in the vicinity of public areas will be performed.
- Islands formed by the clearing limit contour will not be cleared and must be located and marked. This will probably require some exploratory surveying in the wider areas of the reservoir.
- Flowage easements.

b. Contour establishment and mapping. The clearing limit may frequently be located in low, flat terrain with numerous branchings, "finger" sloughs, swales, and may lie in no pattern whatsoever. The prime objective of this type survey is to locate, paint, and map the clearing line contour. In running the levels to locate the contour, the rodmen will be the key to progress. The instrumentman will maintain a hand or electronic notebook, recording all readings for turns. The contour will be temporarily marked when located until a closure has been made and the notes verified. Mapping will be accomplished at a target scale of usually 1 inch = 500 ft.

c. Coverage. It is most probable that long traverses will be required in the lower reaches of the reservoir. In the large heavily wooded areas there will be numerous "finger" sloughs, islands, and peninsulas formed by the contour. Lines, at approximately 1 mile intervals, originating on control at the river banks should be run more or less normal to river, cross section style, a sufficient distance outward to encompass the clearing limit contour and then tied together to form loops. In running these lines, all points where the contour is crossed should be flagged and control points left for continuance of surveys. These lines would serve a dual purpose to locate areas under the clearing limit contour and, after adjustment, as control from which the surveys can be extended. Open areas will be delineated on the map, with proper annotation, such as "cultivated," "pasture," "pasture with scattered trees," "scattered brush and trees," or whatever, so that a classification of type clearing can be made. In large cleared areas the contour can be shot directly on aerial photos, if desired.

d. Markings. Trees standing on or very near the clearing line will be marked in accordance with specifications. These markings shall be placed at intervals such that they are readily intervisible at distances commensurate with the woods cover. All abrupt changes in direction shall be well marked at the point of turn and other prominent trees nearby in both directions. The contour will be marked in open areas--generally at 500 ft to 1000 ft intervals--or closer when required to show important changes in direction. Points where the marked contour is discontinued or resumed (such as the contour entering stream banks or a wildlife and fish habitat area where marking is not required) will be prominently marked. One or more trees should a marked, or enough to insure that this point is readily visible and identifiable.

e. Miscellaneous. Where no surveying of the contour is required within the riverbanks, careful watch for breakouts must be maintained. This may require leveling along the riverbanks and exploration of the mouths of the streams, ditches, sloughs to ensure that the contour is also confined and, therefore, information is needed from which to make a rigid estimate of the acreage involved. In the course of the survey the contour will be outlined and this should be sufficient to determine the length of each area. The width, from the contour down to the timberline next to the water's edge, must be obtained at proper intervals to furnish an excellent average width. Points where these widths are obtained and the widths shall be plotted.

2-10. Upland Disposal Area Surveys

Disposal areas are usually acquired in fee simple and thus will be surveyed and monumented in accordance with state or local codes and standards. Clearing of these areas will be on a graduated basis and it will be necessary under the clearing limit to part off only the portions of the areas required for the original dredging. Limits of the required areas will be furnished to the survey party, and the survey work can be accomplished using the area boundary monuments as control. These limits will be defined on the ground by appropriate markings. The clearing in the disposal areas will be of lesser quality than the reservoir clearing, so that clearing contour marking will prevail and the contour should be marked in the spoil areas as elsewhere.

2-11. Channel Improvement and Cutoff Surveys

These areas require modified grubbing in addition to clearing and will have to be delineated differently from the normal reservoir clearing. The clearing and grubbing lines for these features are usually outlined in detail on the hydrographic maps and the cut off topographic maps. Using the existing ground control and these layouts, these limits will be established. All angle points in these limits will be marked on the nearest tree. Enough intervening trees to promote intervisibility will be marked. In order to furnish data for a close estimate of area of the channel improvement sites, the streamward edge of the timber shall be shown. Open areas within the cutoff confines will also be shown. This clearing will be of a higher grade and take precedence over the regular reservoir clearing. If it is found that the clearing contour passes through any other channel improvement clearing areas, and at the cutoff areas, marking should be discontinued at the intersection. No marking of the clearing limit contour will be done in the areas of clearing for channel improvement. Clearing maps will be presented as line drawn maps, using the reservoir mapping as a base and utilizing the cultural data, stream outlines, etc.

2-12. Post-Flood High Water Mark Surveys

High water marks are evidence of the highest stages reached by a flood. There are many different types of marks and the proper identification of them is the key to getting meaningful data. For this reason the most experienced man in the field party shall be used to locate the marks. High water marks tend to disappear rapidly after the flood peak. Thus, the survey should be started as soon as possible after the peak. Marks should be identified by means of stakes, flagging, paint, nails, crayon, etc., and field sketches made of locations to guide future survey work. Elevations can be obtained for the marks when time permits. Criteria for selecting high water marks are as follows:

- Marks should be selected on surfaces parallel to the line of flow so that they represent the water surface and not the energy grade line of the stream.
- Often small seeds of various plants will provide excellent high water marks, remaining in the crevices of bark or in cracks in fence posts or utility poles. The highest of such particles should be used.

- Mud or silt will often leave easily recognizable lines along banks or on trees, brush, rocks, buildings, etc.
- Excellent high water marks may be found on buildings within the flood plane. Excellent marks may be found on windowpanes or screens. However, care must be exercised not to select marks on the upstream side of the building, which may have been affected by velocity head.
- Residents may afford a valuable source of information when evidence has been cleaned up or destroyed by rain. Such information may be particularly reliable where the water has come into buildings on the premises.

Poorly defined high water marks:

- Drift found on bushes or trees in or near the channel may afford false information. On trees the buildup on the upstream side caused by current may cause an abnormally high reading, and conversely on the downstream side. Bushes may bend with the current and, after the slowdown, straighten up to lift the drift above the peak flood elevation.
- Foam lines, commonly found on bridge abutments, wingwalls, riprap, poles, trees, etc., may be affected by velocity head pileup.
- Wash lines are usually poor.
- Information from residents after passage of time and destruction of evidence, especially when remote from place of residence.

The type of marks should be fully described to facilitate recovery by others. Examples include "drift on bank," "drift on tree," "wash line," "silt line on post," etc. Marks should be rated as "excellent," "good," "fair," or "poor." Attribute data may include:

- Number, river or basin, bank of river.
- Month and year of flood.
- State, county, nearest town.
- Section, Township, Range, if possible.
- Specific location by description from nearest town, etc.
- Specific description of mark, e.g., "nail in post."
- Source of information.
- Type of mark.
- Sketch on right hand page of notebook.

If possible, mark may be tied to existing horizontal control. Otherwise, autonomous/differential GPS or spotting on quadrangle or other map may be the only available method of locating, especially in remote areas. All marks should be leveled to Third Order accuracy standards. Readings should be to nearest 0.01 ft. A TBM should be set in the vicinity to facilitate ties to any future comparative marks.

2-13. Route Surveys

Route surveys are most commonly used for levees, stream channels, highways, railways, canals, power transmission lines, pipelines, and other utilities. In general, route surveys consist of:

- Determining ground configuration and the location of objects within and along a proposed route.
- Establishing the linear or curvilinear alignment of the route.
- Determining volumes of earthwork required for construction.

After the initial staking of the alignment has been closed through a set of primary control points and adjustments have been made, center-line/baseline stationing will identify all points established on the route. Differential levels are established through the area from two benchmarks previously established. Cross-sections in the past were taken left and right of centerline. Today digital terrain models (DTM) or photogrammetry is used to produce cross-sections for design grades. Surveys may be conducted to check these sections at intermittent stations along the centerline. Ground elevations and features will be recorded as required.

2-14. Bridge Surveys

Bridge surveys are often required for navigation projects. In many instances, a plan of the bridge may be available from the highway department, county engineer, railroad, etc. When as-built drawings can be obtained, it may be substituted for portions of the data required herein. However, an accuracy check should be made in the field. Field survey measurements should include the elevation of bridge floor, low steel, and a ground section under bridge to present an accurate portrait of the bridge opening. Piers, bents, and piling should be located with widths or thicknesses being measured so that their volume can be computed and deducted from the effective opening under the bridge. Superstructure is not important and need not be shown. However, guardrail elevations should be obtained and the rails described as to whether they are of solid or open construction. A very brief description of bridge as to type of construction (wood, steel, concrete, etc.) and its general condition should be furnished. If wingwalls exist, minimum measurements should be made to draw them in proper perspective. Sketches of existing bridges may be required on many of the various types of surveys performed by a District. Obtain digital photographs of all bridges. All photographs should be carefully indexed, and a sketch made to show approximate position and angle of each exposure. In general, survey data to be included on bridge survey field notes should include:

- Direction facing bridge, whether upstream or downstream.
- Length of bridge, or stationing if established.
- Distances from center to center of piers or bents.
- Dimensions of piers or pilings including batter.
- Low chord (or steel) elevation over channel.
- Profile of bridge deck, roadway, handrail, etc.
- Sketch of plan of bridge, when required, showing deck dimensions including girder size and spacing.
- Sketch of typical bent, when required, including cap size.
- Sketch of wingwall, when required.
- Digital photographs from various aspects.
- Material of which constructed (wood, steel, concrete, prestressed concrete, etc.).
- Type of construction, such as truss, trestle, or girder.
- General condition of bridge.
- Alignment of bridge to channel, whether normal or at angle (may be shown on plan sketch).
- Alignment of piers or bents, whether normal or at angle.
- Composition of bents may be indicated on sketch.
- Designation of highway, road, street, railroad, etc., utilizing bridge--describe surface, if road.

An example of field notes for a typical bridge survey is shown in Chapter 12.

2-15. Artillery Surveys (FM 3-34.331)

The Field Artillery (FA) is a primary user of precise positioning and orientation information in a wartime environment. Topographic survey support must be provided to multiple launch rocket system (MLRS) units, Corps's general support units, and other nondivisional assets in the Corps area. The FA requires that topographic surveyors:

- Establish and recover monumented survey control points (SCPs)--horizontal and vertical--and azimuthal references for conventional and inertial FA survey teams.
- Coordinate the exact position of the high-order control with the Corps's survey officer.
- Augment FA survey sections when appropriate.

Topographic-engineer companies are the primary source of topographic support throughout the Echelons above Corps (EAC) and general support. Topographic companies support artillery surveys by:

- Extending horizontal and vertical control into the corps and division areas.
- Providing a survey planning and coordination element (SPCE) in support of the EAC.
- Providing mapping-survey control where required.
- Advising on topographic matters.
- Assisting in lower-level surveys to augment FA surveys.

Additional details on field artillery surveys are found in Chapter 9 of FM 3-34.331

2-16. Airport Obstruction and NAVAID Surveys (FM 3-34.331)

Airfield-obstruction and NAVAID surveying operations involve obtaining accurate and complete NAVAID (and associated airport/heliport-obstruction) and geodetic positioning data. Airport obstruction chart (AOC) surveys provide source information on:

- Runways and stopways.
- NAVAIDs.
- Federal Aviation Regulation defined obstructions.
- Aircraft-movement aprons.
- Prominent airport buildings.
- Selected roads and other traverse ways.
- Cultural and natural features of landmark value.
- Miscellaneous and special-request items.

a. NSRS connection requirements. AOC surveys also establish or verify geodetic control in the airport vicinity is accurately connected to the NSRS. This control and the NSRS connection ensure accurate relativity between these points on the airport and other surveyed points in the NSRS, including GPS navigational satellites. AOC data is used to:

- Develop instrument approach and departure procedures.
- Determine maximum takeoff weights.
- Certify airports for certain types of operations.
- Update official aeronautical publications.

- Provide geodetic control for engineering projects related to runway/taxiway construction, NAVAID positioning, obstruction clearing, and other airport improvements.
- Assist in airport planning and land-use studies.
- Support activities such as aircraft accident investigations and special projects.

b. Survey standards. Federal Aviation Administration Publication 405 (*Standards for Aeronautical Surveys and Related Products*, Fourth Edition., 1996.) and Federal Aviation Regulation 77 (*Objects Affecting Navigable Airspace*, 15 July 1996) outline the requirements for AOC surveys. Various areas, surfaces, reference points, dimensions, and specifications used in airfield surveys are described in these references.

c. Runway surveys. All length and width measurements are determined to the nearest foot. If the runway's threshold is displaced, the distance (in feet) is given from the beginning of the runway's surface. Determine the coordinates (latitude and longitude) of the runway's threshold and stop end at the runway's centerline. Elevations at the runway's threshold, stop end, and highest elevation (within the first 3,000 feet of each runway touchdown zone elevation [TDZE]) should be determined to the nearest 0.1 ft from the MSL. In addition, prepare runway profiles that show the elevations listed above, the runway's high and low points, grade changes, and gradients. Determine the elevation of a point on the instrumented runway's centerline nearest to the instrument landing system (ILS) and the glide-path transmitter to the nearest 0.1-ft MSL.

d. NAVAID surveys. Airports requiring airfield-obstruction and NAVAID surveys are instrumented runways. The exact point on the radar, the reflectors, the runway intercepts, and the instrument landing system (ILS) and microwave-landing-system (MLS) components depend on the survey type, the location, and the required accuracy. The requirement to verify the existing ILS/MLS, their proper description, and all components on or near the runway are mandatory. Obtain information for locating and describing all airfield features with help from airfield operation and maintenance section, and control tower personnel.

e. Obstruction surveys. An obstruction is an object or feature protruding through or above any navigational imaginary surface that poses a threat to the safe operation of aircraft. Navigational imaginary surfaces or obstruction identification surfaces are defined in Federal Aviation Regulation 77.

f. Reference. Additional details (including accuracy specifications) on airport obstruction and NAVAID surveys are found in Chapter 10 of FM 3-34.331



Figure 2-3. Airfield NAVAID positioning using Fast-Static GPS methods

2-17. Site Plan Engineering Drawings

An engineering site plan survey is a topographic (and, if necessary, hydrographic) survey from which a project is conceived, justified, designed, and built. Types of surveys that are performed for developing site plan drawings include:

- Hydrographic Surveys--surveys of USACE navigation, flood control, or reservoir projects (see EM 1110-2-1003 (*Hydrographic Surveying*)).
- Beach Profile Surveys--surveys of renourishment projects, shore protection features, and structures.
- Levee Surveys--surveys of levees, revetments, and other related river control structures.
- Route Surveys--surveys of proposed or existing transportation routes.
- Quantity Surveys--surveys for construction measurement and payment.
- Structure Surveys--surveys of facilities, utilities, or structures.

The methods used in performing an engineering survey can and sometimes will involve all of the equipment and techniques available. GPS survey techniques are covered in EM 1110-1-1003 (*NAVSTAR GPS Surveying*). Many of these GPS techniques are used in establishing control for topographic surveys. Photogrammetry may also be used to produce maps of almost any scale and corresponding contour interval--see EM 1110-1-1000 (*Photogrammetric Mapping*). Profiles and cross sections may also be obtained from aerial photos. The accuracy of the photogrammetric product varies directly with the flight

altitude or photo scale--these factors must be considered when planning such a project. Surveys of structural deformations are not topographic surveys. These types of surveys are detailed in EM 1110-2-1009 (*Structural Deformation Surveying*). Preliminary, General, and Detailed Site Plans are often specified, as described below.

a. Preliminary Site Plans (Pre-engineering surveys). Based on reconnaissance surveys previously described, the first plans to be prepared are preliminary site studies showing in skeleton form only the general arrangement of areas where construction will take place, circulation between them and to training areas, public roads, and serving railroads. The most convenient scale for these studies on sizeable projects has usually been 1 inch = 400 ft; on smaller projects, 1 inch = 300 or 200 ft.

b. Approved General Site Plan. Upon the basis of these studies, a general site plan, at the same scale, is reached; and serves as basis for enlargement for detailed site plans and for general utility plans described below. This approved site plan will show:

- Grid System.
- Buildings (indicate types).
- Wooded Areas
- Roads and Fences (indicate roadway widths and types of base and surface).
- Service and Parking Areas.
- Rail Facilities, including access to serving railroad.
- Use Areas of all kinds (runways, aprons, firebreaks, parade grounds, etc.)

c. Detailed Site Plans. Based on the topographic surveys described above, and enlarged from the approved preliminary site plan, detailed site plans at the scale of 1 inch = 200 ft or larger are prepared. In the case of large developments such as cantonments, the detailed site plans often encompass an area about equal to that utilized by a regiment and may be drawn at as large a scale as 1 inch = 50 ft. The detailed site plans serve as a basis for detailed utility plans.

2-18. Army Installation Mapping Requirements

Each installation is guided by its respective service's comprehensive or master planning requirements. Each installation, depending on its mission, may have substantially more or fewer theme specific maps. It is the responsibility of the installation's planning, environmental operations, engineering, and administrative staff to understand the mapping needs for their installation. Each installation is unique and the specific quantity and type of maps required for an installation depend upon its individual features, conditions, and requirements. An installation will generally produce and maintain a set of maps to meet both its planning and operational needs. The following list (from ERDC/ITL 1999b--*CADD/GIS Technology Center Guidelines for Installation Mapping and Geospatial Data*) is representative of the geospatial map layers needed on a typical installation.

A-Natural and Cultural Resources

- A-1 Areas of Critical Concern
 - Historic Preservation and Archeology
 - Threatened and Endangered Species
 - Wetlands & Floodplains
 - State Coastal Zones
 - Lakes, Rivers, Streams, and Water Bodies
 - Soil Borings & Soil Types
- A-2 Management Areas
 - Geology, including Surface Features
 - Topography & Physiology
 - Hydrology
 - Vegetation Types
 - Forest (Commercial Timber)
 - Agriculture Grazing/Crops
 - Fish and Wildlife
 - Prime & Unique Soils
 - Grounds Categories
 - Climate & Weather
 - Bird Aircraft Strike Hazard (BASH)
 - Outdoor Recreation
 - Pest Management

B-Environmental Quality

- B-1 Environmental Regulatory
 - Hazardous Waste Generation Points
 - Permitted Hazardous Facilities
 - Solid Waste Generation Points
 - Solid Waste Disposal Locations
 - Fuel Storage Tanks
 - Installation Restoration Program (IRP)
- B-2 Environmental Emissions
 - Air Emission
 - Waste Water NPDES Discharge
 - Storm Water NPDES Discharge
 - Drinking Water Supply Sources
 - Electromagnetic and Radiation Sources
 - Radon Sources

C-Layout and Vicinity Maps

- C-1 Installation Layout
- C-2 Off-base Sites
- C-3 Regional Location
- C-4 Vicinity Location
- C-5 Aerial Photographs

- C-6 Installation Boundary

D-Land Use

- D-1 Existing Land Use
 - D-1.1 Future Land Use
- D-2 Off-base Sites Land Use
 - D-2.1 Off-base Sites Future Land Use
- D-3 Real Estate
- D 4 Explosive Safety Quantity-Distance (QD) Arc
- D-5 Hazard Analysis Constraints
- D-6 Composite Installation Constraints and Opportunities
- D-7 Area Development

E-Airfield Operations

- E-1 On base Obstruction to Airfield and Airspace Criteria
- E-2 Approach and Departure - Zone Obstructions to 10,000 Ft
- E-3 Approach and Departure Zone Obstructions Beyond 10,000 Ft
- E-4 Airspace Obstruction - Vicinity
- E-5 Terminal Enroute Procedures (TERPS) Automation Plan
- E-6 Airfield and Airspace Clearances
 - Waivers
 - Clear Zones
 - Primary Surfaces
 - Transitional Surface (7:1)
 - Approach & Departure Surface (50:1)
 - Approach and Taxiway Clearances
- E-7 Airfield Pavement Plan
- E-8 Airfield Pavement Details
- E-9 Aircraft Parking Plan
 - E-9.1 Proposed Aircraft Parking Plan
- E-10 Airfield Lighting Systems

F- Reserved

- F-1 Reserved
- F-2 Reserved

G-Utilities System Plan

- G-1 Water Supply System
- G-2 Sanitary Sewerage System
- G-3 Storm Drainage System
- G-4 Electrical Distribution System (Street & Airfield)
- G-5 Central Heating and Cooling System

- G-6 Natural Gas Distribution System
- G-7 Liquid Fuel System
- G-8 Cathodic Protection System
- G-9 Cathodic Protection System Details
- G-10 Industrial Waste and Drain System
- G-11 Composite Utility System Constraints
 - G-11.1 Central Aircraft Support System
- G-12 Other Utility Systems

H-Communication and NAVAID Systems

- H-1 Installation Communication (Base and civilian communications units)
- H-2 NAVAIDs and Weather Facilities

I-Transportation System

- I-1 Community Network Access to Base
- I-2 On-base Network
 - I-2.1 Future Transportation Plan

J-Energy Plan

K-Architectural Compatibility

L-Landscape Development Area

M-Future Development

- M-1 Current Status
- M-2 Short-Range Development
- M-3 Long-Range Development

N-Reserved

- N-1 Reserved
- N-2 Reserved

O- Force Protection

- O-1 Surge Capability (Beddown and Support of Deployed Forces)
- O-2 Physical Security
- O-3 Disaster Preparedness Crash Grid Map
- O-4 Air Base Survivability and Theater-Specific Requirements

P - Ports and Harbors

R - Range and Training Areas

The CADD/GIS Technology Center schema (i.e., database structure/format) for installation maps uses "entity sets" to classify graphic (maps) and non-graphic data (tabular files, reports, database files. etc.). The overall structure is based upon the concept of features, attributes, and values. There are 26 entity sets listed in the latest release of the Spatial Data Standard for Facilities, Infrastructure, and Environment (SDSFIE):

Auditory	Ecology	Land Status
Boundary	Environmental Hazards	Landform
Buildings	Fauna	Military Operations
Cadastre	Flora	Olfactory
Climate	Future Projects	Soil
Common	Geodetic	Transportation
Communications	Geology	Utilities
Cultural	Hydrography	Visual
Demographics	Improvement	

These 26 entity sets are further broken down into Entity Class, Entity Type, and Entity (attributes, descriptors, ranges, etc.), as shown for a typical feature in the plate below.

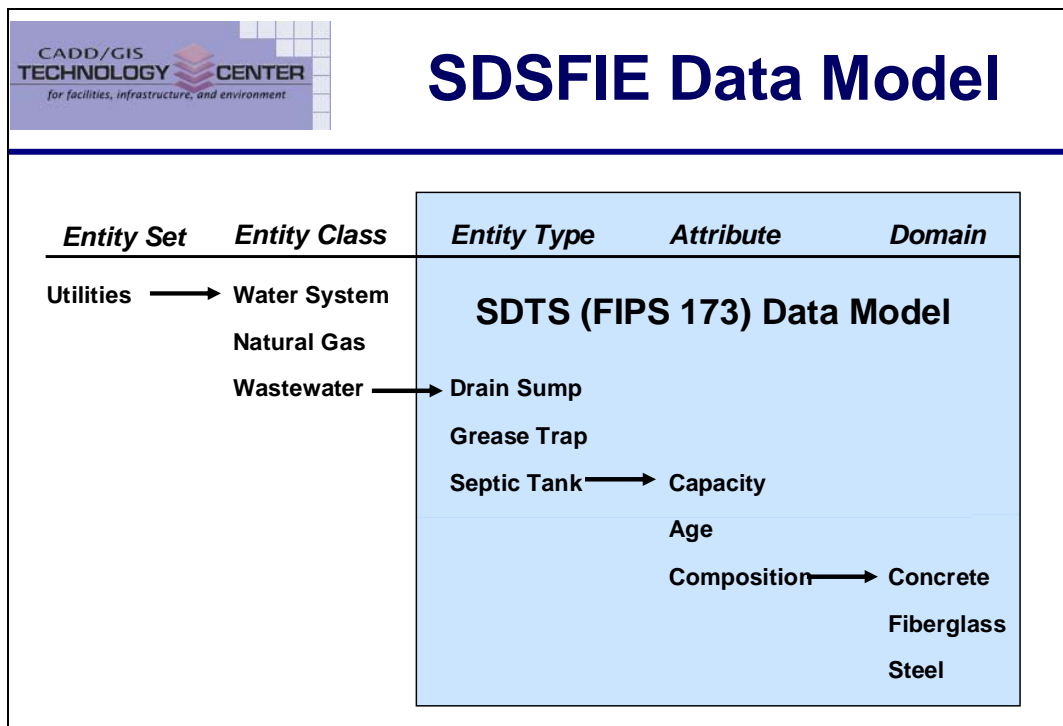

Figure 2-4. Spatial data feature and attribute breakdown for a septic tank (SDSFIE Release 2.300)

Maps supporting Army installations are expected to conform to the SDSFIE data model, and the related Facility Management Standard for Facilities, Infrastructure, and Environment (FMSFIE) non-graphic tables and elements.

SECTION II Survey Methods and Techniques

This section provides an overview of the past and present instruments and methods used to perform topographic surveys of sites, facilities, or infrastructure.

2-19. Older Topographic Surveying Methods

Prior to the advent of total stations, GPS, LIDAR, and data collector systems, transit and plane table topographic surveying methods and instruments were once standard. They are rarely used today, other than perhaps for small surveys when a total station or RTK system is not available. However, the basic field considerations regarding detail and accuracy have not changed, and field observing methods with total stations or RTK are not significantly different from the older survey techniques briefly described in the following sections.

a. Transit-Tape (Chain). Transit tape topographic surveys can be used to locate points from which a map may be drawn. The method generally requires that all observed data be recorded in a field book and the map plotted in the office. Angles from a known station are measured from another known station or azimuth mark to the point to be located and the distance taped (or chained) from the instrument to the point. Transit-tape surveys typically set a baseline along which cross-section hubs were occupied and topographic features were shot in on each cross-section. The elevation of an offset point on a section is determined by vertical angle observations from the transit. The slope or horizontal distance to the offset point is obtained by chaining. The accuracy may be slightly better than the plane table-alidade method or very high (0.1 ft or less), depending upon the equipment combinations used. Transits are still used by some surveying and engineering firms, although on a declining basis if electronic total station equipment is available. Transit-tape surveys can be used for small jobs, such as staking out recreational fields, simple residential lot (mortgage) surveys, and aligning and setting grade for small construction projects. Assuming the project is small and an experienced operator is available, this type of survey method can be effective if no alternative positioning method is available. Detailed procedures for performing and recording transit tape topographic surveys can be found in most of the referenced survey texts listed at Section A-2.

b. Chaining. 100, 200, 300, or 500-foot steel tapes are used for manual distance measurement methods. Woven, cloth, and other types of tapes may also be used for lower accuracy measurements. Maintaining any level of accuracy (e.g., better than 1: 5,000) with a steel tape is a difficult process, and requires two experienced persons. Mistakes/blunders are common. Tapes must be accurately aligned over the points (using plumb bobs), held at a constant, measured tension, and held horizontally (using hand levels). Subsequent corrections for tape sag/tension, temperature, and slope may be necessary if a higher accuracy is required. Taping methods, errors, and corrections are not covered in this manual but may be found in any of the basic surveying texts listed at Appendix A-2.

c. Transit-Stadia. Transit-stadia topographic surveys are performed similarly to transit-tape surveys described above. The only difference is that distances to offset topographic points are measured by stadia "tacheometry" means-- i.e., using the distance proportionate ratio of the horizontal cross hairs in the transit telescope. The multiple horizontal crosshairs in the transit scope can be used to determine distance when observations are made on a level rod at the remote point. This distance measurement technique has been used for decades, and is also the basis of plane table survey distance measurement. The three horizontal crosshairs in the transit are spaced such that the upper and lower crosshair will read 1.0 ft on a rod 100 ft distant from the transit--a "stadia constant" ratio of 100 : 1. (Not all instruments have an even 100 : 1 stadia constant). The accuracy of a stadia-derived distance is not good--probably

about 1 : 500 at best. Thus, a 500 ft shot could have an error of ± 1 ft. Additional errors (and corrections) result from inclined stadia measurements, i.e., when the shot is not horizontal. Reduction of the stadia intercept values to a nominal slope distance, then reduction to horizontal, requires significant computation or use of tables. Transit-stadia was often used like a modern day total station in that topo detail could be densified (typically using radial survey methods) from a single instrument setup. All observed data was recorded in a field book, and occasionally optionally plotted in the field. Transit-stadia techniques are likewise rarely performed today if a total station is available. Details on stadia measurement methods are found in any surveying textbook--e.g., Kavanagh 1997.

d. Transit/Theodolite-EDM. Electronic Distance Measurement (EDM) instruments were first developed in the 1950s, primarily for geodetic operations. In the 1970s, more compact EDM units were mounted atop or alongside transits and theodolites--thus replacing manual chaining or optical stadia distance measurement. Observed data were still recorded in field books for later office hand plotting. These crude transit-EDM combinations were the early forerunner of the modern total stations. During this time, methods were developed for automated drafting of observed features--after individual angles and distances and features were encoded on punch cards and input to a computer/plotter system.



Figure 2-5. Plane table and alidade--Wild T-2 theodolite at right (USC&GS, ca 1960s)

e. Plane table surveying. The plane table and alidade were once the most common tools used to produce detailed site plan maps in the field. The Egyptians are said to have been the first to use a plane table to make large-scale accurate survey maps to represent natural features and man-made structures. Plane table mapping is rarely done today--plane table surveying has, for most purposes, been replaced by aerial photogrammetry and total stations, but the final map is still similar. Plane table surveys were performed in the Corps well into the 1980s, and perhaps into the 1990s in some districts. A plane table survey system is described as follows: A blank map upon which control points and grid ticks have been plotted is mounted on the plane table. The table is mounted on a low tripod with a specially made head--see Figure 2-5 above. The head swivels so that it can be leveled, locked in the level position, and then be rotated so that the base map can be oriented. The base map is a scaled plot of the ground control stations.

Thus, with the table set up over one of the stations, it can be rotated so that the plotted stations lie in their true orientation relative to the points on the ground. Spot elevations and located features are located with an alidade, an instrument that uses optical stadia to determine distance (similar to the transit stadia). The error of a map produced with a plane table and alidade varies across the map as the error in stadia measurements varies with distance. Horizontal errors may range from 0.2 ft at 300 feet, to 10 ft or more at 1,000 feet. Since the elevation of the point is determined from the stadia measurement, relative errors in the vertical result. The plane table survey resulted in a “field-finished” map product, with all quality control and quality assurance performed in the field by the party chief/surveyor. The site plan map delivered from the plane table was immediately suitable for overlaying design detail. Modern day electronic survey and CADD systems are still attempting to attain the same level of “field-finish” capability that the plane table once produced. Older editions of this manual or the surveying textbooks listed in Section A-2 should be consulted if more detailed information on plane table survey techniques and alidade observations is needed.



Figure 2-6. Leica TCR 705 Reflectorless Total Station

2-20. Total Stations

Total stations were first developed in the 1980s by Hewlett-Packard (Brinker and Minnick 1995). These instruments sensed horizontal and vertical angles electronically instead of optically, and combined them with an EDM slope distance to output the X-Y-Z coordinates of a point relative to the instrument's X-Y-Z coordinates. Electronic theodolites operate in a manner similar to optical instruments. Angle readings can be to 1" with precision to 0.5". Digital readouts eliminate the uncertainty associated with reading and

interpolating scale and micrometer data. The electronic angle-measurement system eliminates the horizontal- and vertical-angle errors that normally occur in conventional theodolites. Measurements are based on reading an integrated signal over the surface of the electronic device that produces a mean angular value and eliminates the inaccuracies from eccentricity and circle graduation. These instruments also are equipped with a dual-axis compensator, which automatically corrects both horizontal and vertical angles for any deviation in the plumb line. An EDM device is added to the theodolite and allows for the simultaneous measurements of the angle and the distance. With the addition of a data collector, the total station interfaces directly with onboard microprocessors, external PCs, and software. The ability to perform all measurements and to record the data with a single device has revolutionized surveying. Total stations perform the following basic functions:

Types of measurements:

- Slope distance
- Horizontal angle
- Vertical angle

Operator input to total station data collector:

- Text (date, job number, crew, etc.)
- Atmospheric corrections (PPM)
- Geodetic/grid definitions
- HI & HR
- Descriptor/attribute of setup point, backsight point, sideshot point, stakeout point, etc

In general, there are three types of total station operating modes:

- Reflector--total station requires a solid reflector or retroreflector signal return from the remote point to resolve digital angles and distances. Prisms are attached to a pole positioned over a feature. Requires two-man field crew--operator and rodman.

- Reflectorless--the total station will resolve (and coordinate) signal returns off natural features. Distances may be far more limited than those obtained from reflectors ... typically less than 1,000 ft. Allows for more economical one-man field crew operation.

- Robotic--total station self-tracks single operator/rodman at remote shot or stakeout points. One-man crew operation, with operator normally based at remote rod point.

Additional details on total stations are covered in Chapter 8. Total stations are also extensively covered in the text references listed at Appendix A-2--e.g., Wolf and Ghilani 2002.



Figure 2-7. RTK base station and radio link transmitter--and rover with backpack (Key West Harbor Dredging Project 2004--C&C Technologies, Inc. & Jacksonville District)

2-21. Real Time Kinematic (RTK) GPS

RTK survey methods have become widely used for accurate engineering and construction surveys, including topographic site plan mapping, construction stake out, construction equipment location, and hydrographic surveying. RTK survey systems operate in a similar fashion as the robotic total station, with one major exception being that a visual line of sight between the reference point and remote data collection point is not required. Both RTK and total stations use similar data collection routines and methods, and can perform identical COGO stake out functions. Kinematic surveying is a GPS carrier phase surveying technique that allows the user to rapidly and accurately measure baselines while moving from one point to the next, stopping only briefly at the unknown points, or in dynamic motion such as a survey boat or aircraft. A reference receiver is set up at a known station and a remote, or rover, receiver traverses between the unknown points to be positioned. The data is collected and processed (either in real-time or post-time) to obtain accurate positions to the centimeter level. Real-time kinematic solutions of X-Y-Z locations using the carrier (not code) phase are referred to as "real-time kinematic" (RTK) surveys. However, included in this definition are "post-processed real-time kinematic" (PPRTK) techniques where the kinematic solution is not actually performed in "real-time." RTK (or PPRTK) survey techniques require some form of initialization to resolve the carrier phase ambiguities. This is done in real-time using "On-the-Fly" (OTF) processing techniques. Periodic loss of satellite lock can be tolerated and no static initialization is required to regain the integers. This differs from other GPS techniques that require static initialization while the user is stationary. A communication link between the reference and rover receivers is required to maintain a real-time solution. Additional details on performing topographic surveys with RTK are covered in Chapter 9.

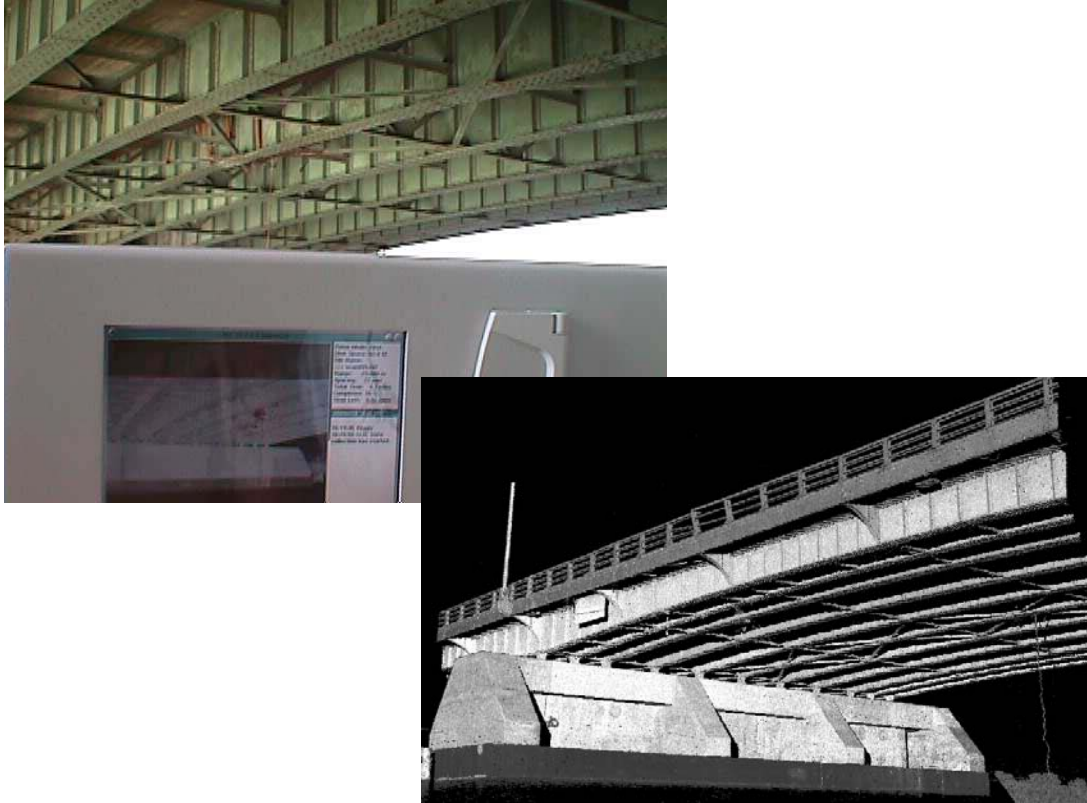

Figure 2-8. Optech LIDAR scanner and resultant image of underside of Kennedy Bridge
(Arc Surveying & Mapping, Inc.--Puerto Rico 2002)

2-22. Terrestrial LIDAR (Laser) Scanning

Laser scanning instruments have been developed that will provide topographic detail of structures and facilities at an extremely high density, as shown in Figure 2-8 above. These tripod-mounted instruments operate similarly to a reflectorless total station. However, they are capable of scanning the entire field of view with centimeter-level pixel density in some cases. A full 3D model of a project site or facility results from the scan. This model must be edited and feature attributes added. See Chapter 10 for additional descriptions of terrestrial LIDAR survey procedures and applications.

2-23. Topographic Data Collection Procedures

Uniform operating procedures are needed to avoid confusion when collecting topographic survey data, especially for detailed utility surveys. The use of proper field procedures is essential to prevent confusion in generating the final site plan map. Collection of survey points in a meaningful pattern aids in identifying map features. The following guidelines are applicable to all types of topographic survey methods, including total stations and RTK systems.

a. Establish primary horizontal and vertical control for radial survey. This includes bringing control into the site and establishing setup points for the radial survey. Primary control is usually brought into the site from established NSRS monuments/benchmarks using static or kinematic GPS survey methods and/or differential leveling. Supplemental traverses between radial setup points can be conducted with a total station as the radial survey is being performed. A RTK system may require only one setup base; however, supplemental checkpoints may be required for site calibration. Elevations are

established for the radial traverse points and/or RTK calibration points using conventional leveling techniques. Total station trigonometric elevations or RTK elevations may be used if vertical accuracy is not critical--i.e., ± 0.1 ft.

b. Perform radial surveys to obtain information for mapping. Set the total station or RTK base over control points established as described above. Measure and record the distance from the control point up to the electronic center of the instrument (HI), as well as the height of the prism or RTK antenna on the prism pole (HR). To prevent significant errors in the elevations, the surveyor must report and record any change in the height of the prism pole. For accuracy, use a suitable prism and target that matches optical and electrical offsets of the total station. Use of fixed-height (e.g., 2-meter) prism poles is recommended for total station or RTK observations, where practical.

c. Collect topographic feature data in a specific sequence. Collect planimetric features (roads, buildings, etc.) first. Enter ground elevation data points needed to fully define the topography. Observe and define break lines. Use the break lines in the process of interpolating the contours to establish regions for each interpolation set. Contour interpolation will not cross break lines. Assume that features such as road edges or streams are break lines. They do not need to be redefined. Enter any additional definition of ridges, vertical, fault lines, and other features.

d. Draw a sketch of planimetric features. A field book sketch or video of planimetric features is an essential ingredient to proper deciphering of field data. The sketch may also be made on a pen tablet PC. The sketch does not need to be drawn to scale and may be crude, but must be complete. Numbers listed on the sketch show point locations. The sketch helps the CADD operator who has probably never been to the jobsite confirm that the feature codes are correct by checking the sketch.

e. Obtain points in sequence. The translation of field data to a CADD program will connect points that have codes associated with linear features (such as the edge of road) if the points are obtained in sequence. For example, the surveyor should define an edge of a road by giving shots at intervals on one setup. Another point code, such as natural ground, will break the sequence and will stop formation of a line on the subsequent CADD file. The surveyor should then obtain the opposite road edge. Data collector software with "field-finish" capabilities will facilitate coding of continuous features.

f. Use proper collection techniques. Using proper techniques to collect planimetric features can give automatic definition of many of these features in the CADD design file. This basic picture helps in operation orientation and results in easier completion of the features on the map. Improper techniques can create problems for office personnel during analysis of the collected data. The function performed by the surveyor in determining which points to obtain and the order in which they are gathered is crucial. This task is often done by the party chief. Cross training in office procedures gives field personnel a better understanding of proper field techniques.

(1) Most crews will make and record 250 to over 1,000 measurements per day, depending on the shot point detail required. This includes any notes that must be put into the system to define what was measured. A learning curve is involved in the establishment of productivity standards. A crew usually has to complete five to six mapping projects to become confident enough with their equipment and the feature coding system to start reaching system potential.

(2) A one or two-person survey crew is most efficient when the spacing of the measurements is less than 50 feet. When working within this distance, the average rod person can acquire the next target during the time it takes the instrument operator to complete the measurement and input the codes to the data collector. The instrument operator usually spends about 20 seconds sighting a target and recording a

measurement and another 5-10 seconds coding the measurement. The same time sequences are applicable for a one-man topographic survey using a robotic total station or RTK.

(3) When the general spacing of the measurements exceeds 50 feet, having a second rod person may increase productivity. A second rod person allows the crew to have a target available for measurement when the instrument operator is ready to start another measurement coding sequence. Once the measurement is completed, the rod person can move to the next shot, and the instrument operator can code the measurement while the rod people are moving. If the distance of that move is 50 feet or greater, the instrument will be idle if you have only one rod person.

(4) Communication between rod person and instrument person is commonly done via radio or cell phone. The rodmen can work independently in taking ground shots or single features; or they can work together by leapfrogging along planimetric or topographic feature lines. When more than one rod person is used, crew members should switch jobs throughout the day. This helps to eliminate fatigue in the person operating the instrument.

2-24. Automated Field Data Collection

Since the 1990s, survey data collection has progressed from hand recording to field-finish data processing. Prior to the implementation of data collectors, control survey data and topographic feature data were recorded in a standard field book for subsequent office adjustment, processing, and plotting. Modern data collectors can perform all these functions in the field. This includes least squares adjustments of control networks, full feature attributing, symbology assignment to features, and on-screen drafting/plotting capabilities. Data collectors either are built into a total station or are separate instruments. A separate (independent) data collector is advantageous in that it can be used for a variety of survey instruments--e.g., total station, digital level, GPS receiver. Field data collector files are downloaded to an office PC platform where the field data can be edited and modified so it can be directly input into a CADD or GIS software package for subsequent design and analysis uses. Many upgraded CADD/GIS software packages can directly download field data from the collector without going through interim software (e.g., CVTPC). Subsequent chapters in this manual (i.e. Chapters 7 and 11) provide additional information on data collectors and the transition of field collected data to office processing systems.

a. Field survey books. Even with fully automated data collection, field survey books are not obsolete. They must be used as a legal record of the survey, even though most of the observational data is referenced in a data file. Field books are used to certify work performed on a project (personnel, date, time, etc.). They are also necessary to record detailed sketches of facilities, utilities, or other features that cannot be easily developed (or sketched) in a data collector. When legal boundary surveys are performed that involve ties to corners, it is recommended that supplemental observations and notes be maintained in the field book, even though a data collector is used to record the observations.

b. Field Coordinate Geometry (COGO) computations. Most data collectors now have a full field capability to perform any surveying computation required. Some of the main field computational capabilities that are found on state-of-the-art data collectors include:

- Coordinate computations from radial direction-distance observations
- Multiple angle/direction adjustments
- Offset object correction (horizontal or vertical)
- EDM meteorological, slope, and sea level reductions
- Horizontal grid and datum transformations

- Vertical datum transformations
- GPS baseline reductions (static, kinematic)
- Traverse adjustments (various methods)
- Inverse and forward position computations
- Resections (2, 3 or more point adjustments)
- Level net adjustments (trig or differential)
- RTK site calibration adjustments (regression fits)
- Construction stake out (slope, horizontal & vertical curves, transition/spiral curves, etc.)

c. Feature coding and attributing. Data collectors are designed to encode observed topographic features with a systematic identification. Similar features will have the same descriptor code--e.g., "BS" for "backsight" and "EP" for "edge of pavement." Features that are recorded in the data collector can have additional attributes added. Attributes might include details about the feature being located (e.g., the number of lamps and height of a light pole).

d. Field graphic and symbology displays. Many field data collectors have symbology libraries which can be assigned to standard features, e.g., manholes, culverts, curb lines, etc. Plotted display of collected points with symbology can be viewed on the data collector display screen, or transferred to a portable laptop screen that has a larger viewing area. This allows for a visual view in the field of observed data in order to check for errors and omissions before departing the job site. This capability is, in effect, a modern day form of a plane table.

e. Data transfer. Digital survey data collected in the field is transferred from the data collector to a laptop or desktop PC for final processing and plotting in CADD (e.g., MicroStation, AutoCAD). Both original and processed data observations are transferred. Original (raw) data includes the unreduced slope distances, HIs, HRs, backsight and foresight directions, etc. Field processed data includes items such as reduced horizontal distances, adjusted coordinates, features, attributes, symbology, etc. Many field-finish software packages can generate level/layer assignments that will be compatible with CADD packages.

f. Reference. Additional details on data collectors and COGO are covered in Chapter 7 of this manual.

2-25. Methods of Delineating and Densifying Topographic Features

A variety of methods can be used to tie in planimetric features or measure ground elevations. Some type of systematic process is used to ensure full coverage of a job site--e.g., running cross-sections from a centerline baseline or a grid pattern. Feature accuracy will also vary: an invert elevation will be shot to 0.01 ft whereas ground shots on irregular terrain are recorded to the nearest 0.1 ft; the horizontal location of a building corner or road centerline will be to the nearest 0.01 ft but a tree can be positioned to the nearest foot.

a. Cross-section survey methods. Most site plan topographic surveys are performed relative to project baselines. This is often called the "right-angle offset technique" (Kavanagh 1997). A baseline is established along a planned or existing project axis (e.g., road centerline) using standard traverse control survey methods, as shown in Figure 2-9. Intermediate points are set and marked at regular intervals along the baseline (at 50-ft or 100-ft stations with intermediate stations added at critical points). The intermediate points are marked with 2x2 inch wooden hubs, PK nails, or temporary pins with flagging. Station hubs are occupied with a transit or total station and cross-sections are taken normal to the baseline alignment. Points along the cross-section offsets are shot for feature and/or elevation. Offset alignment is done either visually, with a right-angle glass, or transit, depending on the accuracy required. Distances

along offsets are measured by chaining, stadia, or EDM (i.e., total station). Detailed notes and sketches of ground shots and planimetric features are recorded in a standard field book, electronic data collector, or both. Notekeeping formats will vary with the type of project and data being collected. General industry standard notekeeping formats should be used, such as those shown in any of the texts listed under Appendix A-2. Examples of selected topographic baseline notes are shown in Figures 2-10 and 2-11 and in Chapter 12.

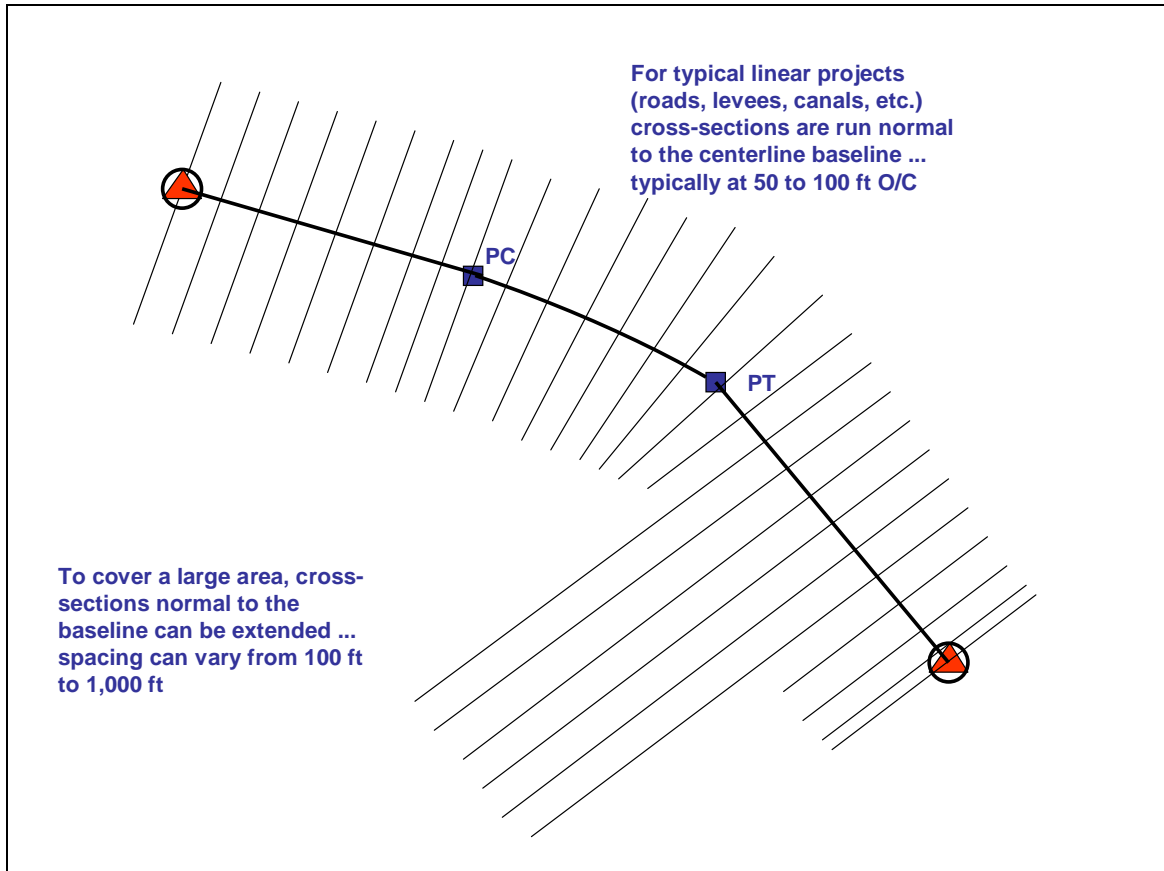

Figure 2-9. Illustration of cross-sections alignments run normal to established baselines

A grid pattern of cross-sections is also used for topographic survey of large areas, such as wetlands, orchards, swamps, etc. This is also illustrated in Figure 2-9 above where the cross-sections southeast of the PT extend a considerable distance from the baseline. In general, the maximum distance to extend the baseline is a function of the feature accuracy requirements and the precision of the survey instrument. For total stations, ground shots on a prism rod out to 1,000 ft and greater are usually acceptable. Transit stadia distances should not extend out beyond 500 ft. If coverage beyond 1,000 ft is needed, then additional baselines need to be run through the area and intermediate cross-sections should be connected between these baselines. (In current practice, this is rarely performed anymore--radial methods with a total station or RTK system are far more productive).

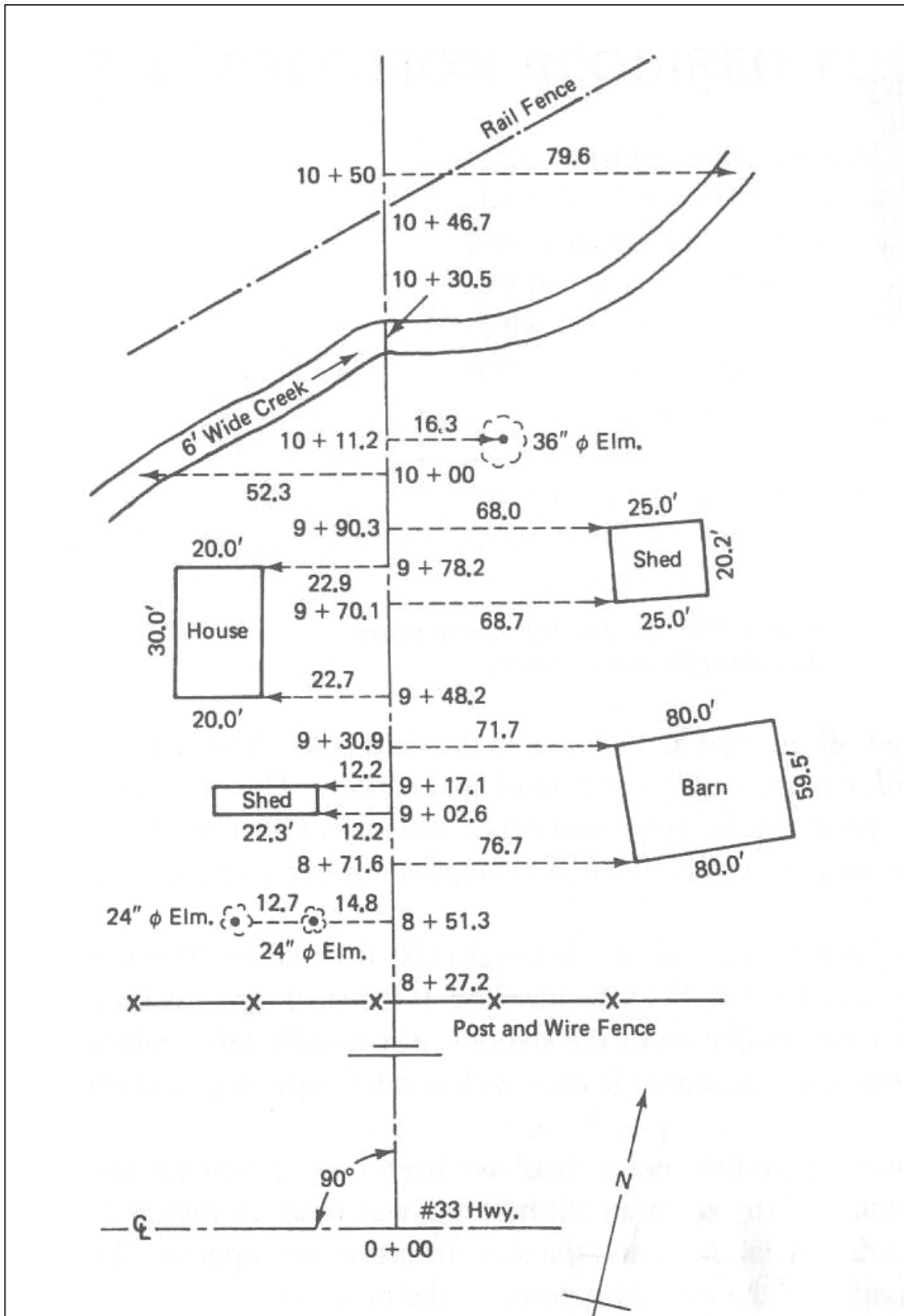

Figure 2-10. Sketch of profile line and cross-section (Kavanagh 1997)

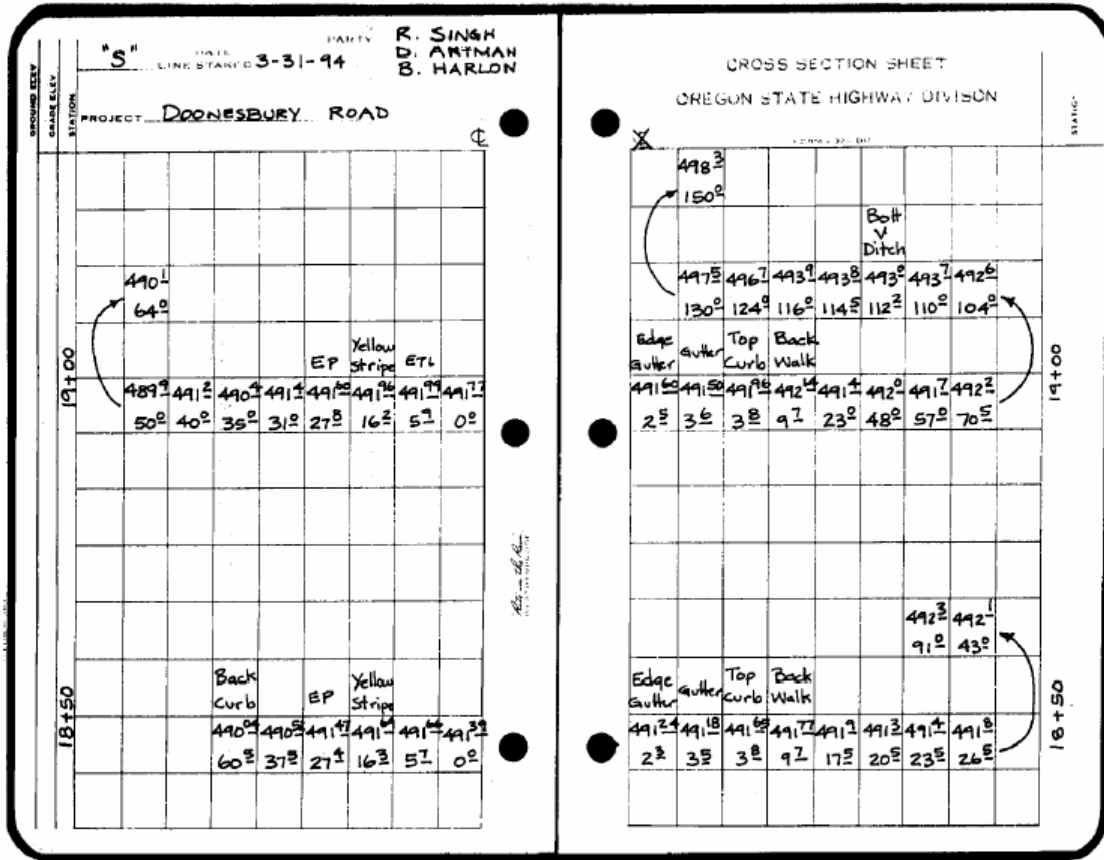

Figure 2-11. Example of field book notes showing location relative to centerline and elevation data from two cross-sections spaced 50-ft C/C (Oregon DOT 2000)

b. *Radial survey methods.* (Figure 2-12). Plane tables were especially suited to radial survey methods; thus, most surveys using total stations or RTK now utilize this technique. Radial observations are made with the instrument (total station or RTK base station) set up over a single point that has full project area visibility (or in the case of RTK, can encompass radio or cell phone ranges well beyond visible limitations with a total station). Thus, topographic features, baseline stakeout, and elevations can be surveyed without having to occupy separate stations along a fixed baseline. COGO packages will automatically compute radial distances and azimuths to linear or curved baseline stations, and visually guide the stakeout process. RTK surveys methods are a unique form of radial survey methods--RTK controller COGO packages are used to reduce GPS observations and guide alignment. Planimetric and ground elevation coverage is performed in a systematic pattern to ensure that the project site is adequately covered. This was straightforward on a plane table--the drawing could be viewed for omissions. On electronic data collector devices, verifying coverage before breaking down the instruments is not as easy. Data collector display screens are typically small and not all field data may have been collected using "field-finish" string (polyline) type coding.

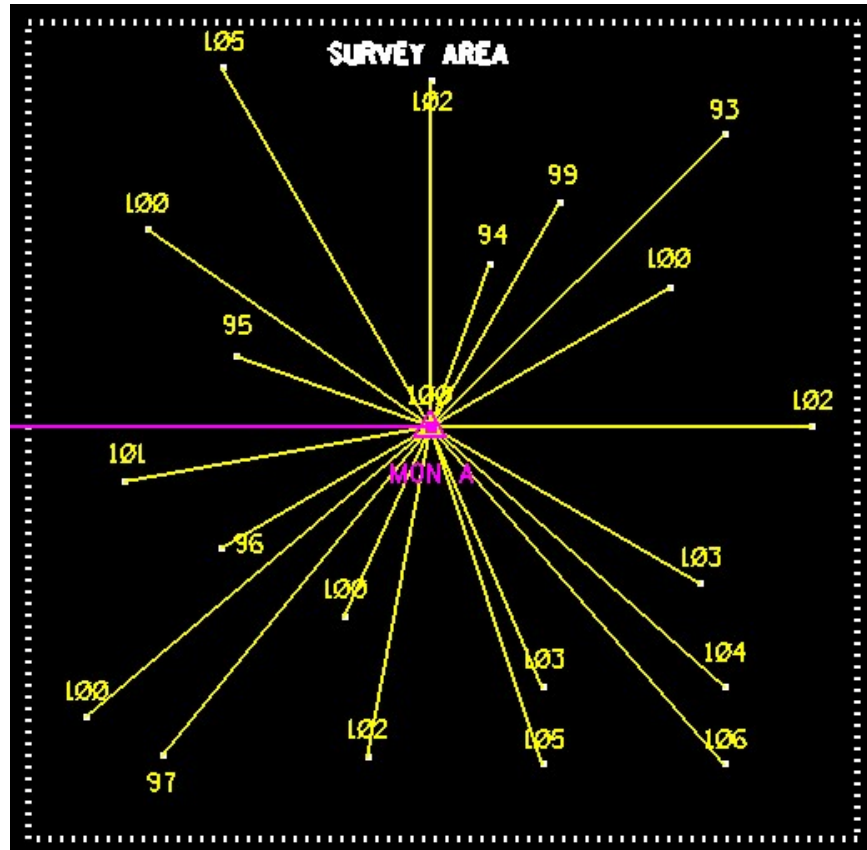

Figure 2-12. Topographic detail densification using radial survey methods--instrument set at point "MON A" and radial shot points (planimetric features or elevations) are observed

c. Planimetric features. Planimetric features are tied in using either cross-section or radial survey methods. The amount of detail required on a feature depends on the nature of the project and the size of the feature relative to the target scale. On small-scale topographic mapping projects, a generic symbol may be used to represent a feature; however, on a detailed drawing for this same project, the feature may be fully dimensioned. An example would be a 3 ft x 5 ft catch basin: on a 1 inch = 400 ft scale map, this basin would be represented by a symbol at its center point but might be surveyed in detail (all four corner points located) on a 1 inch = 30 ft site plan.

d. Topographic elevations and contours. A variety of survey methods are used to develop the terrain model for a given project area. The technique employed is a function of the type of survey equipment, the detail required, and specified elevation accuracy. In addition, the technique may depend on whether traditional contours or a digital terrain model (DTM) is required.

e. Contours from cross-sections. Contours can be directly surveyed on the ground or derived from a terrain model of spot elevations. When cross-section methods are employed, even contour intercepts along the offsets can be set in the field using a level rod. Alternatively, elevations can be taken at intervals along the cross-section where changes in grade or breaklines occur, and contour intercepts interpolated over the linear portions. If abrupt changes in grade (or breaks in grade) occur between cross-section stations, then supplemental cross-sections may be needed to better represent the terrain and provide more accurate cut/fill quantity takeoffs.

f. Contours from radial surveys--spot elevation matrices. It is often more efficient to generate contours from a DTM based on spot elevations taken over a project area. These surveys are normally done with a total station or RTK system; however, older transit-stadia or plane table methods will also provide the same result. The density of spot elevations is based on the desired contour interval and terrain gradient. In some instances, an evenly spaced grid of spot elevations may be specified (so-called "post" spacing). Flat areas require fewer spots to delineate the feature. Breaklines in the terrain are separately surveyed to ensure the final terrain model is correctly represented. Data points can be connected using triangular irregular network (TIN) methods and contours generated directly from the TIN in various CADD packages (MicroStation InRoads, AutoCAD, etc.). The generated DTM or TIN also provides a capability to perform "surface-to-surface" volume computations.

g. DTM generation from breakline survey technique. The following guidance is excerpted from the California Department of Transportation (CALTRANS) *Surveys Manual*. It describes a technique used by CALTRANS to develop DTMs on total station topographic surveys.

A DTM is a representation of the surface of the earth using a triangulated irregular network (TIN). The TIN models the surface with a series of triangular planes. Each of the vertices of an individual triangle is a coordinated (x,y,z) topographic data point. The triangles are formed from the data points by a computer program which creates a seamless, triangulated surface without gaps or overlaps between triangles. Triangles are created so that their sides do not cross breaklines. Triangles on either side of breaklines have common sides along the breakline.

Breaklines define the points where slopes change in grade (the intersection of two planes). Examples of breaklines are the crown of pavement, edge of pavement, edge of shoulder, flow line, top of curb, back of sidewalk, toe of slope, top of cut, and top of bank. Breaklines within existing highway rights of way are clearly defined, while breaklines on natural ground are more difficult to determine. DTMs are created by locating topographic data points that define breaklines and random spot elevation points. The data points are collected at random intervals along longitudinal break lines with observations spaced sufficiently close together to accurately define the profile of the breakline. Like contours, break lines do not cross themselves or other break lines. Cross-sections can be generated from the finished DTM for any given alignments.

Method: When creating field-generated DTMs, data points are gathered along DTM breaklines, and randomly at spot elevation points, using the total station radial survey method. This method is called a DTM breakline survey. Because the photogrammetric method in most cases is more cost effective, gathering data for DTMs using field methods should be limited to small areas or to provide supplemental information for photogrammetrically determined DTMs. The number of breaklines actually surveyed can be reduced for objects of a constant shape such as curbs. To do this, a standard cross section for such objects is sketched and made part of the field notes. Field-collected breaklines are identified by line numbers and type on the sketch along with distances and changes in elevation between the breaklines. With this information in the field notes, only selected breaklines need to be located in the field, while others are generated in the office based on the standard cross section. Advantages of DTM breakline surveys:

- *Safety of field crews is increased because need to continually cross traffic is eliminated.*
- *Observations at specific intervals (stations) are not required.*
- *New sets of cross sections can be easily created for each alignment change.*

DTM survey guidelines:

- Remember to visualize the TIN that will be created to model the ground surface and how breaklines control placement of triangles.
- Use proper topo codes, point numbering, and line numbers.
- Use a special terrain code (e.g., 701) for critical points between breaklines, around drop inlets and culverts, and on natural ground in relatively level areas.
- Make a sketch of the area to be surveyed identifying breaklines by number.
- Do not change breakline codes without creating a new line.
- Take shots on breaklines at approximately 20 m intervals and at changes in grade.
- Locate data points at high points and low points and on a grid of approximately 20 m centers when the terrain cannot be defined by breaklines.
- If ground around trees is uniform, tree locations may be used as DTM data points by using a terrain code of 701.
- Keep site distances to a length that will ensure that data point elevations meet desired accuracies.
- Gather one extra line of terrain points 5 to 10 m outside the work limits.

Accuracy Standard: Data points located on paved surfaces or any engineering works should be located within ± 10 mm horizontally and ± 7 mm vertically. Data points on original ground should be located within ± 30 mm horizontally and vertically.

Checking: Check data points by various means including reviewing the resultant DTM, reviewing breaklines in profile, and locating some data points from more than one setup.

Products: The Surveys Branch is responsible for developing and delivering final, checked engineering survey products, including DTMs, to the survey requestors. Products can be tailored to the needs of the requestor whenever feasible, but normally should be kept in digital form and include the following items:

- Converted and adjusted existing record alignments, as requested. (CAiCE project subdirectory)
- Surveyed digital alignments of existing roadways and similar facilities. (CAiCE project subdirectory)
- CAiCE DTM surface files. (CAiCE project subdirectory)
- 2-D CADD MicroStation design files, .dgn format.
- Hard copy topographic map with border, title block, labeled contours, and planimetry.
- File of all surveyed points with coordinates and descriptions. (CTMED, .rpt, format)

h. Utility survey detail methods. It is important to locate all significant utility facilities. Utilities are surveyed using either total station or RTK techniques. The CALTRANS *Surveys Manual* recommends that accuracy specifications for utilities that are data points located on paved surfaces or any engineering works should be located within ± 10 mm horizontally and ± 7 mm vertically. Data points on original ground should be located within ± 30 mm horizontally and vertically. The following are lists of facilities and critical points to be located for various utilities--as recommended in the CALTRANS *Surveys Manual*.

Oil and Gas Pipelines

- Intersection point with centerlines and/or right of way lines

- *For lines parallel to right of way – location ties necessary to show relationship to the right of way lines*
- *Vents*
- *Angle points*
- *Meter vaults, valve pits, etc.*

Water and Sewer Lines

- *Intersection point with centerlines and/or right of way lines*
- *For lines parallel to right of way – location ties necessary to show relationship to the right of way lines*
- *Manholes, valve boxes, meter pits, crosses, tees, bends, etc.*
- *Elevation on waterlines, sewer inverts, and manhole rings*
- *Fire hydrants*
- *Curb stops*
- *Overhead Lines*
- *Supporting structures on each side of roadway with elevation of neutral or lowest conductor at each centerline crossing point.*
- *On lines parallel to roadway, supporting structures that may require relocation, including overhead guys, stubs, and anchors*

Underground Lines

- *Cables/lines (denote direct burial or conduit, if known), etc.*
- *Manholes, pull boxes, and transformer pads*
- *Crossing at centerline or right of way lines*
- *For lines parallel to right of way – location ties as necessary to show relationship to the right of way lines*

Railroads

- *Profile and location 60 m each side of the proposed roadway right of way lines*
- *Switch points, signal, railroad facilities, communication line locations, etc.*

Checking: Utility data should be checked by the following means:

- *Compare field collected data with existing utility maps*
- *Compare field collected data with the project topo map/DTM*
- *Review profiles of field collected data*
- *Include field collected data, which have elevations, in project DTM*
- *Locate some data points from more than one setup*

i. Archaeological Site/Environmentally Sensitive Area Surveys (CALTRANS). Archaeological and environmental site surveys are performed for planning and engineering studies. Surveys staff must work closely with the appropriate specialists and the survey requestor to correctly identify archeological and environmentally sensitive data points.

Method: Total station radial survey, GPS fast-static, kinematic, or RTK.

Accuracy Standard: Data points located on paved surfaces or engineering works should be located within ± 10 mm horizontally and ± 7 mm vertically. Data points on original grounds should be located within ± 30 mm horizontally and vertically. Review field survey package for possible higher required accuracy.

Checking: Check data points by various means including, reviewing the resultant DTM, reviewing breaklines in profile, and locating some data points from more than one setup.

Products:

- *3-D digital graphic file of mapped area*
- *Hard copy topographic map with border, title block, and planimetry (contours and elevations only if specifically requested)*
- *File of all surveyed points with coordinates and descriptions*

j. Spot Location or Monitoring Surveys (CALTRANS). Monitoring surveys are undertaken for monitoring wells, bore hole sites, and other needs.

Method: Total station radial survey, GPS fast static or kinematic

Accuracy Standard: Data points located on paved surfaces or any engineering works should be located within ± 10 mm horizontally and ± 7 mm vertically. Data points on original ground should be located within ± 30 mm horizontally and vertically.

Checking: Observe data points with multiple ties.

Products:

- *File of all surveyed points with coordinates and descriptions*
- *Sketch or map showing locations of data points*

k. Vertical Clearance Surveys (CALTRANS). Vertical clearance surveys are undertaken to measure vertical clearances for signs, overhead wires, and bridges.

Method: Total station radial method.

Accuracy Standard: Data points located on paved surfaces or any engineering works should be located within ± 10 mm horizontally and ± 7 mm vertically. Data points on original ground should be located within ± 30 mm horizontally and vertically.

Checking: Observe data points with multiple ties.

Products:

- *File of all surveyed points with coordinates and descriptions*
- *Sketch or map showing vertical clearances*

2-26. General QC and QA Guidance on Topographic Data Collection and Drawings

The following guidance is excerpted from the Woolpert, Inc. "Survey Manual." It contains a "checklist" of critical features and attributes that must be collected for various types of utilities, roads, boundaries, facilities, HTRW sites, and other structures. It is followed by a "Drawing Annotation Checklist" that provides general guidance on attributing various features.

INTRODUCTION: Topographic surveys are the basis for the engineering, planning, and development plans. It is critical that the information shown on the plans be correct and complete. It is also very important to understand the intended use or accuracy requirements needed by the user of the plan along with the size of the project. This information can be useful to determine whether the project should be collected by aerial mapping of ground run surveys. If the plan is to be used for engineering design then the field survey will likely include pavement sections and utility locations.

ITEMS INCLUDED ON SURVEYS

Topography (General)

- *Performed by using trigonometric techniques with the Total Station or digitized by aerial photography.*
- *Provide and identify the natural relief of the ground, and man-made structures.*
- *Topography (Location)*
- *Natural*
- *Establish the location of "top of bank", "toe of slope," and centerline of all streams or creeks.*
- *Provide cross sections at specified intervals – typically 20 meters or 50 ft.*
- *Provide a "spot grade" shot +/- 30 ft away from "top of bank" at the cross section interval*
- *Provide a "top of water" shot at every 1000 ft interval – record date and time if tidal area or recent weather events if not tidal.*
- *Sizes of trees will be identified by common name and/or scientific name, and their diameter will be measured at DBH or "diameter at breast height."*
- *Provide location of isolated or cultivated trees*
- *Provide location of edge of woods at outside "drip line."*
- *Locate all high points and low points along ridges and valleys.*
- *Note: Some circumstances may require the location of: spoil piles, sink holes, standing water, caves, and unusual rock outcrops.*
- *Note: Some circumstances may require the locations of the "thread" or "thalweg line" when providing a profile of a stream.*
- *Wetlands*
- *Delineation of a wetland can be located only after flags have been set by an environmental scientist from either the Army Corps of Engineers or Department of Transportation.*

Ditches and Drainage Features

- *Establish the location of "top of bank", "toe of slope," and centerline of all ditches.*
- *Provide cross sections at specified intervals – typically 20 meters or 50 ft.*
- *Provide a "spot grade" shot – typically +/- 30 feet away from "top of bank" at the cross section interval.*

- *Locate any concrete or asphalt: flumes, V-ditches, UD – drains or channels.*
- *Locate all yard drop inlets and curb drop inlets.*
- *Locate all headwalls and wing walls.*
- *Measure the diameter and note the type of all pipes.*
- *Provide location and elevation on invert (flow line) of pipe.*

Storm and Gravity Sanitary Sewers

- *Obtain elevations and location on the tops of manholes or drop inlets.*
- *Measure readings (downs) from rim of manhole to inverts*
- *Locate and provide elevations on inverts and manholes on the next structure out of the limits.*
- *Obtain location and elevations on inverts on box culverts*
- *Obtain location and elevations on inverts on ends of flared-end-section pipes*
- *Locate sanitary sewer clean outs*
- *Locate and describe sanitary sewer pump stations (lift stations).*
- *Locate approximate areas of septic fields and tanks.*

Roads

- *Locate and measure all curb and gutter features: Back of curb, flow line, and edge of gutter pan.*
- *Note size and type of curb and gutter.*
- *Provide location of edge of pavement at specified intervals – typically 20 meters or 50 ft.*
- *Note size and type of pavement.*
- *Provide location of centerline or “crown” of road.*
- *Obtain and locate all entrances.*
- *If concrete pavement has been overlaid with asphalt, measure approximate depth of overlay.*
- *Locate and note types of guardrails.*
- *Locate and provide elevations at the base of Jersey barrier.*

Railroads

- *Provide location of tracks with elevations at specified intervals--typically 20 meters or 50 ft in a curve. Note: Some special circumstances may also include location and elevations for the ballast rock and railroad bed.*
- *Obtain location of all switches.*
- *Obtain location of all mileposts. Note: Most crossing signals provide distances to closest milepost. If a railroad milepost cannot be located, the closest railroad spur must be located and tied.*
- *Obtain location of all signal equipment.*
- *Obtain location of all Right-of-way monuments.*
- *Obtain location, size, and type of culverts under the railroad.*
- *Secure a copy of the railroad right-of-way map.*

Fences

- *Provide location, type, and height of fence.*
- *Common types of fences are split rail, wood privacy, chain link, woven wire, barbed wire, etc.*

Cemeteries

- *Location of cemetery boundary must be shown.*
- *Locate graves coincident with the Right-of-way and survey centerline.*
- *Provide an approximate count of the number of graves.*

Automobile Graveyards

- *Locate outside limits and note approximate number of automobiles.*

Signs

- *Locate and describe all overhead truss signs.*
- *Locate and describe all overhead cantilever signs.*
- *Locate and describe all breakaway I-beam traffic signs.*
- *Locate and describe all traffic signals.*
- *Locate and describe all historical markers – recording identity numbers.*
- *Locate, measure, and describe in detail all advertising signs or commercial billboards. It is imperative to note the owner and the license number.*

House & Building Location

- *Locate all dwellings and buildings at the wall or footer line and note/dimension the overhang.*
- *Describe as dwellings, buildings, restaurants, etc.*
- *Identify structure address: example) house or box number.*
- *Describe the height of structures: example) one story, two story, or split-level.*
- *Describe the type of construction: example) brick, wood frame.*
- *Locate and describe all porches, decks, carports, utility buildings, and driveways.*

Utility Items--Above Ground Utility Location

- *Utility poles and guy wire anchors – recording number and owner.*
- *Light poles – recording number and owner.*
- *Cable TV pedestals – recording number and owner.*
- *Electric – cabinet, transformer, junction box, hand hole, witness post, meter, transmission tower, and Sub-Stations (note: do not enter facility).*
- *Water meters, valves, vaults, manholes, blow off valves, fire hydrants and witness posts.*
- *Gas meters, valves, test stations, and witness posts.*
- *Force main air vents and witness posts along line as well as valves and emergency pump connections at pump station facility (note: do not enter facility).*
- *Steam pipes and steam manholes.*
- *Petroleum pipes, witness posts, and pumping stations (note: do not enter facility).*
- *Communication or telephone manholes, pedestals, hand holes, and witness posts – recording number and owner.*
- *Traffic control signals, manholes, cabinets, junction boxes, and hand holes.*

Political Boundaries & Road Names

- *Provide location of all monuments of city or town corporate limits.*
- *Obtain the location of all monuments pertaining to county or state lines.*
- *Locate all street name signs and route number identifiers.*

Government Survey Control

- *Locate all government benchmarks.*
- *Locate all government triangulation, trilateration, and traverse stations.*
- *Locate all government reference marks and azimuth marks.*
- *Locate all state Right-of-way monuments.*

Property Data – (If required)

- *Obtain Right-of-way plans from State Location and Design Engineer.*
- *Obtain pertinent data from court records such as; subdivision plats, parcel, or tract deeds and plats, and tax assessor's cards and maps.*
- *Provide location of all property monuments called for in the deed as needed per scope*
- *Provide location of all easements.*

Hazardous Material/Waste Sites

- *Typically, all hazardous waste sites or potential waste sites will be noted.*
- *Obtain site plan of suspected area*
- *Note and record pertinent information on location of underground storage tanks, filler caps, monitoring wells and caps.*

Set TBMs

- *Obtain and verify vertical datum as per scope: Assumed, City datum, NGVD29, or NAVD88.*
- *A minimum of two temporary benchmarks will be set on private topographic surveys.*
- *TBMs will be set an interval of 1000 ft. to 1500 ft. on typical corridor surveys.*

DRAWING ANNOTATION CHECKLIST

- *Advertising Signs (Billboards): Locate if needed and show license number and owner (small license plate).*
- *Automobile Graveyards: Locate the outside limits and annotate.*
- *Brush, shrubbery, woods: Annotate as dense, light, mixed, etc., and type. Example: (Tree types). Description of trees: describe the type of tree, not just hardwood and pine unless it cannot be identified. Use "Shrub" instead of "Bush" in all cases.*
- *Buildings: Locate at the overhangs and annotate type brick, frame, etc., the height (one story, two story, etc.), and name if commercial. Carports, porches, steps, walks, etc., will also be shown. Example: (1 Story frame dwelling #3098), (2 Story brick building #4139); Building numbers need to be shown. If no number is visible note that, do not leave it blank. Sheds are structures with a roof, and four support posts; Buildings are structures enclosed by four sides, and a door; a Dwelling is a structure that someone lives in; a Commercial Building is a business; and a Restaurant is a structure that someone eats in. The occupant of a Commercial building shall also be identified, i.e. Exxon or First Union Bank. Strip malls will be called out as such or by the name of the shopping center.*
- *Bridges: Annotate type, with deck.*
- *Curbs and Gutters: Annotate type and size.*

- *Cemeteries: Locate the extremities, the closest grave to the centerline and annotate the approximate number of graves.*
- *Concrete or Paved Ditches: Annotate type and width. Flow elevations and directions will be secured by a field survey.*
- *Concrete or Paved Flumes: Annotate type and width. Flow elevations and directions will be secured by a field survey.*
- *Curbs: Annotate type and size.*
- *Culverts: Annotate type, size, secure invert elevations, and direction of flow.*
- *Dams: Annotate type.*
- *Entrances: Annotate type (soil, gravel, asphalt, etc.).*
- *Electric Manholes and junction boxes: Annotate.*
- *Endwalls and Headwalls: Annotate type.*
- *Fences: Annotate Height and type (wood, wire, or chain link), no split rail or woven wire.*
- *Fire Hydrants: Annotate.*
- *Guardrails: Annotate type.*
- *Guy Wires: Need to be annotated and located (number and furthest wire if more than one).*
- *Government Benchmarks, Triangulation Stations, Traverse Stations, Azimuth Marks, and Reference Marks: Annotate.*
- *Historical Marks: Annotate identification numbers.*
- *High Voltage Transmission Lines: Annotate. Electric transmission lines should be shown on the survey. Show one Tower outside the limits. List the number of lines on each tower. We do not need to show the location of the overhead lines.*
- *Light poles: Should be described differently, based upon use. The light poles along roadways are to be called out as "Street Light"; the lights in a shopping center, at a service station, around a hotel are to be shown as "Security Light." The light poles in someone's yard would be shown as "Lamp Post" and ground lights illuminating signs, etc. would be shown as "Outdoor Lights."*
- *Mile Markers: Annotate*

- *Names of all cities, towns, and villages must be annotated and all corporate limits, county and state lines located and annotated.*
- *Outlet Ditches: Annotate with directions of flow.*
- *Pavements: Annotate type and if concrete covered with asphalt, make notations.*
- *Pipes: Annotate type, size, invert elevations, and direction flow.*
- *Property Data: Corners will be located and annotated. All pins within the limits of the survey should be obtained if possible, especially each lot within a subdivision, not just pc and pt points on the subdivisions right-of-way.*
- *Ponds and Lakes: Annotate and collect DTM data inside the edge of water line styles.*
- *Roads: Annotate route numbers and street names and type.*
- *Right-of Way Monuments: Annotate.*
- *Railroads: Annotate owners, right-of-way, and distance to the nearest milepost.*
- *Sewage Disposal and Water Supply: Annotate for each individual developed property, privy, well, sewer clean outs, water meters, drain fields, septic tanks, etc. See homeowner if necessary.*
- *Special Signs: Annotate overhead truss, signal traffic lights, railroad protective devices, etc. (No street signs or speed limit signs are needed). Location and description of all other signs is required. Private signs should be picked up and described, as well as the type of supports, concrete pads or bases, and heights (especially the tall service station and restaurant signs that can be seen from the interstates). All green signs along interstate should be shown and described as on wood posts or steel breakaway posts, and if they are on concrete or not. Street signs should be picked up and identified as "Street Sign." Reflector posts, curve signs, speed limit signs, other delineator signs should not be picked up. If they show up in the mapping put an X through them.*
- *Storm and Sanitary Sewers: Annotate type. Example: SMH= Sanitary, SSMH=Storm, DI, etc. Secure rim elevations, inverts and/or flow lines of all structures. For curb drop inlets show elevation at low point of the throat, usually the center of actual box and measure the length of the throat.*
- *Telephone M.H.'s, pedestals, handholes: Annotate.*
- *Trees: Annotate type and size with the diameter measured three feet above the ground. If unsure of type, hardwood or pine will do.*
- *Utility Poles and Pedestals: Annotate number and owner initials. Include information if pole has light or transformer. Example: T-Ped-#R-1680, B.A. (Bell Atlantic) PP-AB-53, V.P. (Virginia Power).*
- *Walls: Annotate type, height, and width.*

- *Witness posts: annotate type.*
 - *Identify gas station filler caps, monitoring wells and locate concrete pads around them.*
 - *Identifying areas of possible hazardous materials and type of possible contamination.*
 - *Use common sense...annotate, edit and/or revise areas not covered in the above and correct all discrepancies in mapping.*
 - *Set TBM's or BM's approximately 1500 feet apart. They can be on the centerline. They should also be at all drainage crossings (canals, etc.) and bridges.*
 - *Use discretion when setting nails in trees for references. Do not use ID caps on private property.*
-

1-6. Use of Manual

This manual is intended to be a USACE reference guide for control surveying, site plan mapping, and infrastructure utility feature mapping. These activities may be performed by hired-labor forces, contracted forces, or combinations thereof. This manual will also be used as the primary reference manual for Proponent Sponsored Engineer Corps Training (PROSPECT) courses on topographic surveying. Accuracy specifications, procedural criteria, and quality control requirements contained in this manual may be directly referenced in the scopes of work for Architect-Engineer (A-E) survey services or other third-party survey services, including construction contracts. This is intended to assure that uniform and standardized procedures are followed by both hired-labor and contract service sources throughout USACE.



Figure 1-1. PROSPECT topographic survey training course “Surveying III”
USACE Professional Development Support Center, Huntsville, AL (2003)

1-7. Scope of Manual

The overall scope of this manual is limited to ground-based survey methods--specifically, georeferenced observations taken from survey instruments set up on tripods over fixed control points or benchmarks. These methods usually provide the highest accuracy for engineering surveys, and are necessary when surface and subsurface utilities must be definitively located and identified. Therefore, less-accurate and less-detailed remote aerial mapping techniques are excluded. However, ground-based topographic surveys covered in this manual are normally required to supplement generalized aerial topography, and to provide feature details on surface and subsurface infrastructure. Control survey applications are limited to establishing supplemental (or secondary) reference points at a project site from which detailed topographic mapping or construction stake out is performed. Geodetic control survey methods used for high-order densification of the national reference network (i.e., the National Spatial Reference System--NSRS) are not covered in this manual--see EM 1110-1-1003 (*NAVSTAR GPS Surveying*) for performing precise geodetic control surveys.

a. Technical references. Technical or procedural guidance is in more general terms where methodologies are described in readily available references or in survey instrumentation and data collector operation manuals. This manual does not duplicate elementary surveying topics that are adequately covered in a number of academic texts, such as those recommended in paragraph A-2 at Appendix A. References to these publications will be provided to avoid unnecessary redundant coverage of elementary topics. It is strongly recommended that a user performing control or topographic surveys acquire one of these textbooks. Topics that will be referenced include instrument set-up and operation, taping and chaining, instrument calibrations, basic surveying theory and accuracy estimates, traditional survey distance, curve and area computations, traverse adjustments, etc. Reference is also made to various survey and CADD manuals published by State Departments of Transportation (DOT). An excellent example is the California Department of Transportation *Surveys Manual* (CALTRANS Surveys Manual 2001-2004), a 14 chapter publication that can be downloaded at the CALTRANS web site www.dot.ca.gov/hq/esc/geometronics. Chapters in the CALTRANS *Surveys Manual* are periodically updated as new equipment or techniques are developed. Since design and construction surveys performed by many State DOTs are nearly identical to Corps of Engineers applications, these DOT manuals represent an excellent up-to-date resource on procedures, instrumentation, standards, and specifications.

b. Manual coverage and appendices. The first few chapters in this manual are intended to provide a general overview of control and topographic survey procedures, equipment, and standards. Reference systems and datums used on Corps civil projects and military installations are described in Chapter 5. Subsequent chapters cover survey planning, data collection, data processing, and generation of digital or hard copy site plans. Examples of different topographic survey methods are included--e.g., total station, LIDAR, GPS. Sample topographic survey projects are included within chapters or appendices. Examples include those surveys typically performed on Corps civil works or military construction projects, such as navigation, flood control, real estate, facility design and maintenance, lock and dam surveys, and utility surveys. The final chapter on estimating costs for topographic surveys is intended to assist those USACE commands that contract out these services. Sample scopes of works to contracted and hired-labor field personnel are provided, including data deliverable requirements, are provided in this chapter and in the appendices. The appendices also include a number of Corps project applications where topographic surveys were performed in support of civil and military design and construction.

c. Evolving technology and procedures. Survey equipment operation, calibration, and procedural methods for acquiring, logging, processing, and plotting topographic survey data are adequately detailed in operation manuals provided by the various instrument manufacturers and software vendors. Since instrument and data collector operations (and data processing methods) are unique to each vendor, and are being constantly updated, this manual can only provide a general overview of some of the more common techniques used by the Corps or its contractors. As new survey instruments, technology, and machine control integration procedures are developed, Districts are strongly encouraged to use those innovations and recommend modifications to any criteria or technical guidance contained in this manual--see Proponency and Waivers section at the end of this chapter. Other Corps regulations may dictate mandatory requirements for processing, displaying, transferring, and archiving survey data--e.g., metadata archiving. These regulations will be referenced where applicable.

d. Manual development. Technical development and compilation of this manual was coordinated in 2004-2005 by the US Army Engineer Research and Development Center--Topographic Engineering Center (CEERD-TR-A). The following USACE Districts provided project examples and/or performed technical reviews on various drafts of the manual: Jacksonville, Louisville, New Orleans, Pittsburgh, Philadelphia, Portland, Rock Island, St. Louis, Tulsa, and Walla Walla. The original version of this manual (*Topographic Surveying*) was developed in the early 1990s by the USACE Topographic Engineering Center at Fort Belvoir, and published on 31 August 1994. This latest update consolidates control

surveying topics from EM 1110-1-1004 (*Geodetic and Control Surveying*), dated 1 Jun 02. EM 1110-1-1004 is superseded by this consolidation into EM 1110-1-1005.

1-8. Life Cycle Project Management Applicability

Project control established during the planning phase of a project may be used through the entire life cycle of the project, spanning decades in many cases. During initial reconnaissance surveys of a project, primary control should be permanently monumented and situated in areas that are conducive to the performance or densification of subsequent surveys for contract site plans, construction, and maintenance. During the early planning phases of a project, a comprehensive survey control plan should be developed which considers survey requirements over a project's life cycle, with a goal of eliminating duplicative or redundant surveys to the maximum extent possible.

1-9. Metrics and Accuracy Definitions

Both English and metric units are used in this manual. Metric units are commonly used in survey instrumentation, such as electronic distance measurement and in GPS surveys. Metric-derived geographical or metric Cartesian coordinates are transformed to English units of measurements for use in local project reference and design systems, such as State Plane Coordinate System (SPCS) grids. In all cases, the use of metric units shall follow local engineering and construction practices. English/metric equivalencies are noted where applicable, including the critical--and often statutory--distinction between the US Survey Foot (1,200/3,937 meters (m) exactly) and International Foot (30.48/100 m exactly) conversions. One-dimensional (1D), two-dimensional (2D), and three-dimensional (3D) accuracy statistics, standards, and tolerances specified in this manual are defined at the 95% RMS confidence level. Unless otherwise stated, "positional accuracies" imply horizontal (2D) RMS measures.

1-10. Trade Name Exclusions

The citation or illustration in this manual of trade names of commercially available products, including supporting surveying equipment, instrumentation, and software, does not constitute official endorsement or approval of the use of such products.

1-11. Abbreviations and Terms

Abbreviations, acronyms, and engineering surveying terms used in this manual are explained in the Glossary at the end of this manual.

1-12. Mandatory Requirements

ER 1110-2-1150 (*Engineering and Design for Civil Works Projects*) prescribes that mandatory requirements be identified in engineer manuals. Mandatory accuracy standards, quality control, and quality assurance criteria are normally contained in tables within each chapter, and these requirements are summarized at the end of the chapter. If no mandatory requirements are listed, then the material in a particular chapter is considered recommended guidance. Any mandatory criteria contained in this manual are based on the following considerations: (1) project safety assurance, (2) overall project function, (3) previous Corps experience and practice, (4) Corps-wide geospatial data standardization requirements, (5) adverse economic impacts if criteria are not followed, and (6) HQUSACE commitments to industry standards.

1-13. Governing Engineer Regulations and Related Standards

Spatial coordinates established using topographic survey techniques fall under the definition of geospatial data contained in ER 1110-1-8156 (*Policies, Guidance, and Requirements for Geospatial Data and Systems*). Accordingly, the guidance in ER 1110-1-8156, and its implementing manual EM 1110-1-2909 (*Geospatial Data and Systems*), must be followed for disseminating and archiving survey data. This would include preparing appropriate metadata files in accordance with the guidance in EM 1110-1-2909. Detailed CADD and GIS standards are promulgated by the CADD/GIS Technology Center in Vicksburg, MS. Federal standards for reporting survey accuracy, geodetic control survey standards, and topographic survey standards are also published by the Federal Geographic Data Committee (FGDC). These FGDC "*Geospatial Positioning Accuracy Standards*" are listed in Appendix A.

1-14. Proponency and Waivers

The HQUSACE proponent for this manual is the Engineering and Construction Division, Directorate of Civil Works. Comments, recommended changes, or waivers to this manual should be forwarded through MSC to HQUSACE (ATTN: CECW-CE).

Chapter 3 Primary Control Surveys for Project Mapping

3-1. Purpose and Scope

Control surveys are performed to establish a monumented reference system for a military or civil facility mapping project. These fixed horizontal control points and vertical benchmarks are then used as starting points for supplemental topographic site plan mapping. This chapter provides guidance on the various techniques used to establish project control. FM 3-34.331 (*Topographic Surveying*) contains numerous examples of basic survey data reductions and computations, such as three-wire level reduction, level line reductions, c-factor computations, scale and grid factor computations, and traverse adjustments. This chapter will refer to the Field Manual for many of these topics.

a. Horizontal control survey methods. Horizontal positions of permanent monuments around a facility or project site can be established by a number of survey techniques. These include traditional traverse, triangulation, or trilateration surveys from an established geodetic network on an installation or region (e.g., NSRS). Alternatively, GPS methods can be performed to extend control from an established network to the project site. Since most modern day survey crews or firms possess both GPS and total station equipment, there would be little justification for running lengthy (and costly) traverses or triangulation/trilateration networks to bring in control to a local site. Therefore, this chapter will focus on current practices for performing "traditional" horizontal control surveys--i.e. control being established using total station traverse methods. (This chapter does contain some background on older survey methods for use in basic PROSPECT surveying courses). GPS control survey densification methods are more thoroughly covered in EM 1110-1-1003 (*NAVSTAR GPS Surveying*). Triangulation and trilateration methods will only be briefly addressed, along with references to other publications. Traverse survey methods described in this chapter are largely drawn from FM 3-34.331.

b. Vertical control survey methods. As with horizontal control densification, a number of survey methods can be used to bring vertical control from an established datum into a project site. These include trigonometric leveling (e.g., a total station), differential (spirit) leveling, and differential GPS techniques. Since most facility mapping projects require fairly accurate elevations relative to a local network, traditional differential leveling is still the most effective and reliable method of transferring elevations. GPS elevation transfer methods are reliable over short distances; however, they are not as accurate as differential leveling methods. Refer to EM 1110-1-1003 (*NAVSTAR GPS Surveying*) for details on performing accurate DGPS elevation transfers.

SECTION I Traditional Horizontal Control Survey Techniques

3-2. General Overview

a. Purpose. Horizontal control is established to serve as a basic framework for large mapping projects, to establish new horizontal control in a remote area, or to further densify existing horizontal control in an area.

b. Instruments. Minimum instrument requirements for the establishment of primary control will typically include a repeating theodolite having an optical micrometer with a least-count resolution of six seconds (6") or better; a directional theodolite having an optical micrometer with a least count resolution of one arc-second; an EDM capable of a resolution of 1:10,000; or a total station having capabilities comparable to, or better than, any of the instruments just detailed. A calibrated 100-ft steel tape may also be used for measuring short distances.

c. Monumentation. Primary project horizontal control points not permanently monumented in accordance with criteria and guidance established in EM 1110-1-1002 (*Survey Markers and Monumentation*) should meet the following minimum standards:

(1) Markers. Project horizontal control points should be marked with semi-permanent type markers (e.g., re-bar, railroad spikes, or large spikes). If concrete monuments are required, they will be set prior to horizontal survey work.

(2) Installation. Horizontal control points should be placed either flush with the existing ground level or buried a minimum of one-tenth of a foot below the surface.

(3) Reference marks. Each primary control point should be referenced by a minimum of two points to aid in future recovery of that point. For this reference, well-defined natural or manmade objects may be used. The reference point(s) can be either set or existing and should be within 100 ft of the control point.

(4) Sketches. A sketch should be placed in a standard field survey book or on a standard form, such as DA Form 1959 (Figures 3-1 and 3-2). The sketch, at minimum, will show the relative location of each control point to the reference points and major physical features within 100 ft of the point.

d. Redundancy. A minimum of two repeated angle measurements (i.e. positions or sets) should be made for establishing project control points. With EDM distance measurements, a minimum of two readings should be taken at each setup and recorded in a standard field book (or data collector). The leveled height of the instrument and the height of the reflector should be measured carefully to within 0.01 ft and recorded. Each measured slope distance (taped or EDM) should be reduced to a horizontal distance using either reciprocal vertical angle observations or the known elevation of each point obtained from differential leveling. Duplicate distances should be observed over each line by remeasuring backsight lines at each traverse point set up. Depending on the accuracy requirements, additional sets of angle measurements or EDM distances may be specified--see FGCS 1984.

COUNTRY Germany		TYPE OF MARK 170 Monument		STATION Stone Kamp	
LOCALITY Illesheim/L6528		STAMPING ON MARK NA		AGENCY (CAST IN MARKS) NA	ELEVATION 331.671 ^(FT) (M)
LATITUDE 49°28'10.47467"		LONGITUDE 10°23'10.92519"		DATUM WGS 84	DATUM Amsterdam
(NORTHING) (EASTING) 5,480,852.200 ^(FT) (M)	(EASTING) (NORTHING) 600,444.268 ^(FT) (M)	GRID AND ZONE 32U		ESTABLISHED BY (AGENCY) 320th Engineer	
(NORTHING) (EASTING) (FT) (M)	(EASTING) (NORTHING) (FT) (M)	GRID AND ZONE		DATE (YYYYMMDD) 2001 07 15	ORDER Third
TO OBTAIN		GRID AZIMUTH, ADD		TO THE GEODETIC AZIMUTH	
TO OBTAIN		GRID AZ. (ADD) (SUB.)		TO THE GEODETIC AZIMUTH	
OBJECT	AZIMUTH OR DIRECTION (GEODETIC)(GRID) (MAGNETIC)	BACK AZIMUTH	GEOD. DISTANCE (METERS)	(FEET)	GRID. DISTANCE (METERS)

The station is located on Storch Barracks, Illesheim, Germany.

To reach the station front gate of Storch Barracks (Grid 0082) go straight for 0.1 mile to four-way intersection. Turn right (west) and proceed 0.8 mile to the gate of the access road and a guard shack. Follow the access road around the perimeter of the airfield for 0.9 mile to the station site.

The station is a Type 70 monument protruding 20 cm above the ground and is located atop a berm.

The station is located 75.1 m at an azimuth of 160° from Building 6680, 82.3 m from the hot fuel point and 67 m from the fuel point sign.

Horizontal position was established by third-order class I traverse.

Elevation was established by third-order leveling procedures.

SAMPLE

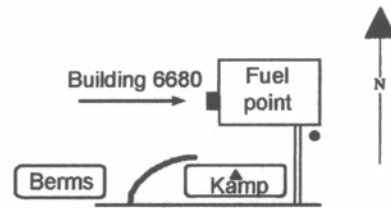

SKETCH

DA FORM 1959, JUL 2001

REPLACES DA FORMS 1959 AND 1960, 1 FEB 57, WHICH ARE OBSOLETE.

DESCRIPTION OR RECOVERY OF HORIZONTAL CONTROL STATION

For use of this form, see FM 3-34.331; the proponent agency is TRADOC.

USAPA V1.00

Figure 3-1. DA Form 1959 -- "Description or Recovery of Horizontal Control Station"

COUNTRY USA		TYPE OF MARK		STATION	
LOCALITY		STAMPING ON MARK		AGENCY (CAST IN MARKS) Corps of Engineers	
LATITUDE		LONGITUDE		DATUM	
<u>(NORTHING)</u> (FT) (M)		<u>(EASTING)</u> (FT) (M)		GRID AND ZONE	
<u>(NORTHING)</u> (FT) (M)		<u>(EASTING)</u> (FT) (M)		GRID AND ZONE	
TO OBTAIN		GRID AZIMUTH, ADD		TO THE GEODETTIC AZIMUTH	
TO OBTAIN		GRID AZ. (ADD) (SUB)		TO THE GEODETTIC AZIMUTH	
OBJECT	AZIMUTH OR DIRECTION (GEODETTIC) (GRID) (MAGNETIC)		BACK AZIMUTH	GEOD DISTANCE (METERS) (FEET)	
	° ' "		° ' "		
SKETCH					

DA FORM 1959 REPLACES DA FORMS 1959 AND 1960, 1FEB 57, WHICH ARE OBSOLETE.

DESCRIPTION OR RECOVERY OF HORIZONTAL CONTROL STATION
 For use of this form, see FM 3-34.331; the proponent agency is TRADOC.

Figure 3-2. Blank DA Form 1959 -- "Description or Recovery of Horizontal Control Station"

e. Repeating theodolite. If a repeating theodolite (e.g., a Wild T1) is used for the horizontal angles, the instrument will be pointed at the backsight station with the telescope in a direct reading position, and the horizontal vernier set to zero degrees. All angles should then be turned to the right, and the first angle recorded in a field book. The angle should be repeated a minimum of four times (i.e. two sets) by alternating the telescope and pointing in the direct and inverted positions. The last angle will also be recorded in the field book. If the first angle deviates more than five seconds (5") from the result of the last angle divided by four, the process should be repeated until the deviation is less than or equal to five seconds. Multiples of 360 degrees may need to be added to the last angle before averaging. The horizon should be closed by repeating this process for all of the sights to be observed from that location. The foresight for the last observation should be the same as the backsight for the first observation. If the sum of all the angles turned at any station deviates more than ten seconds (10") from 360 degrees, the angles should be turned again until the summation is within this tolerance.

f. Directional theodolite. If a directional theodolite (e.g., Wild T2 or Wild T3) is used for the horizontal angles, the instrument should be pointed at the backsight station with the telescope in a direct reading position and the horizontal scales set to within ten seconds (10") of zero degrees. The scales should be brought into coincidence and the angle read and recorded in the field book. The angles (directions) should then be turned to each foresight in a clockwise direction, and the angles read and recorded in a field book. This process will continue in a clockwise direction and should include all sights to be observed from that station. The telescope should then be inverted and the process repeated in reverse order, except the scales are not to be reset, but will be read where it was originally set. The angles between stations may then be computed by differencing the direct and reverse readings. This process of observing a "set" should be repeated two or more times, depending on the survey specification. It is difficult to set the angle values precisely on the plates of an optical theodolite. Angles are determined by reading the initial and the final directions, and then determining the angular difference between the two directions. Optical theodolites are generally very precise--a Wild T2 optical theodolite reads directly to 1". If several sets are required for precision purposes, distribute the initial settings around the plate circle to minimize the effect of circle-graduation distortions--see FM 3-34.331 for recommended circle settings for a 1" theodolite.

g. Horizontal distances. To reduce EDM slope distances to horizontal, a vertical angle observation must be obtained from each end of each line being measured. The vertical angles should be read in both the direct and inverted scope positions and adjusted. If the elevations for the point on each end of the line being measured are obtained by differential leveling, then this vertical angle requirement is not necessary.

h. Targets. All targets established for backsights and foresights should be fixed and centered directly over the measured point. Target sights may be a reflector or other type of target set in a tribrach, a line rod plumbed over the point in a tripod, or guyed/fixed in place from at least three positions. Artificial sights (e.g., a tree on the hill behind the point) or hand held sights (e.g., line rod or plumb bob string) should not be used to set primary control targets.

i. Calibration. All theodolites, total stations, EDM, and prisms used for horizontal control work should be serviced regularly and checked frequently. Tapes and EDMs must be periodically calibrated over lines of known length, such as NGS calibration baselines. Instrument calibrations should be done at least annually. Theodolite instruments should be adjusted for collimation error at least once a year and whenever the difference between direct and reverse reading of any theodolite deviates more than thirty seconds from 180 degrees. Readjustment of the cross hairs and the level (plate) bubble should be done whenever misadjustments affect the instrument reading by more than the least count of the reading scales of the theodolite. Forced centering type tribrachs should be periodically (monthly) checked to ensure the optical plumb line is correct. Circular or "bulls eye" bubbles on tribrachs, total stations, rods, etc. should

be periodically checked and adjusted. Tribrach or total station optical plummets (visual or laser) must be periodically checked. These various calibrations and adjustments are described in the Appendix A-2 references or in FM 3-34.331 (*Topographic Surveying*).

j. Horizontal direction recording. Procedures for recording horizontal directions are the same for all orders of accuracy. Record horizontal directions in a bound field survey book (see Figure 3-3 below), on DA Form 4253 (see FM 3-34.331), or any equivalent electronic recording form. Each time a point is occupied, the following information should be recorded--either on the Title Page or entry page, as appropriate:

Title Page:

- Instrument make, model, and serial number.
- Instrument operator's name.
- Recorder's name.
- Weather description.
 - Temperature.
 - General atmospheric condition.
 - Wind.

Entry Page:

- Designation of the occupied station.
 - Full station name.
 - Year established.
 - Name of the agency on the disk.

The field book or recording form should include the above information for each station observed. If an instrument, signal, or target is set eccentric to a station (not plumbed directly over the station mark), that item should be sketched on the recording form. The sketch should include the distance and the directions that the eccentric item is from the station. When intersection stations are observed, the exact part of the point observed must be recorded and shown on the sketch.

k. Horizontal abstracts of directions. An abstract of horizontal directions should be compiled for every station at which horizontal directions have been observed. DA Form 1916 (see FM 3-34.331) or equivalent field book abstracts should be completed before leaving the point. If a horizon closure is specified, the corrected station angle and the corrected explement angle should be recorded in the field book before leaving the point. If DA Form 1916 is used, readings will be entered opposite the proper circle position, as indicated in the field notes. The degrees and minutes for each direction are entered one time at the top of each column, and the seconds are entered for each circle position.

K @ FRANK, 1982						SEPT. 5, 1985	
Object	D/R	Deg	Min	Sec	Mean	P.C./Notes-Parker	
Y JERRY	D	00	00	15			K-Long
1980	R	180	00	10	12.5		φ-Reet
							φ-Crider
CENTER, '85	D	95	48	39			
	R	275	48	33	36.0	23.5	95° 48'
PAT, '82	D	196	22	06			
	R	16	22	02	04.0	51.5	196° 21'
9/ JERRY '80	R	270	02	38			
	D	90	02	43	40.5		
CENTER, '85	R	15	50	56			
	D	185	50	59	57.5	17.0	95° 48'
PAT, '82	R	106	24	32			
	D	286	24	36	34.0	53.5	196° 21'

SAMPLE FIELD BOOK NOTES--THEODOLITE

Figure 3-3. Sample horizontal field book recording--Directional Theodolite

3-3. Secondary or Temporary Horizontal Control

a. *General.* Secondary horizontal control is established to determine the location of structure sections, cross sections, or topographic features, for construction control, or to pre-mark requirements for small to medium scale photogrammetric mapping. These points are often temporary in nature and can easily be reset from the permanent primary control points.

b. *Requirements.* Secondary horizontal control requirements are identical to that described for primary horizontal control with the following exceptions.

(1) Monumentation. It is not required for secondary horizontal control points to have two reference points. Wooden hubs, PK nails, or other similar markings are adequate. Descriptions or sketches are usually not required.

(2) When a total station or EDM is used, a minimum of two readings should be taken at each setup and recorded in a standard field book or electronic data collector.

(3) If a repeating theodolite is used for the horizontal angles, the angle measurement should be repeated a minimum of two times by alternating the telescope and pointing in the direct and inverted positions.

(4) If a directional theodolite is used for the horizontal angles, the process (described for primary control) should be repeated two times--for a total of two data set collections.

3-4. Bearing and Azimuth Determination

Horizontal angles are usually turned (or deflected) to the right or left. The three types of angle measurements are as follows:

- Interior angles. If angles in a closed figure are to be measured, the interior angles are normally read. When all interior angles have been recorded, the accuracy of the work can be determined by comparing the sum of the abstracted angles with the computed value for the closed loop (Figure 3-4 below).
- Deflection angles. In an open traverse (Figure 3-4), the deflection angles are measured from the prolongation of the backsight line to the foresight line. The angles are measured either to the left or to the right. The direction must be shown along with the numerical value.
- Vertical angles. Vertical angles can be referenced to a horizontal or vertical line (Figure 3-5). Optical-micrometer theodolites measure vertical angles from the zenith (90° or 270° indicate a horizontal line). Zenith and nadir are terms describing points on a sphere. The zenith point is directly above the observer, and the nadir point is directly below the observer. The observer, the zenith, and the nadir are on the same vertical line.

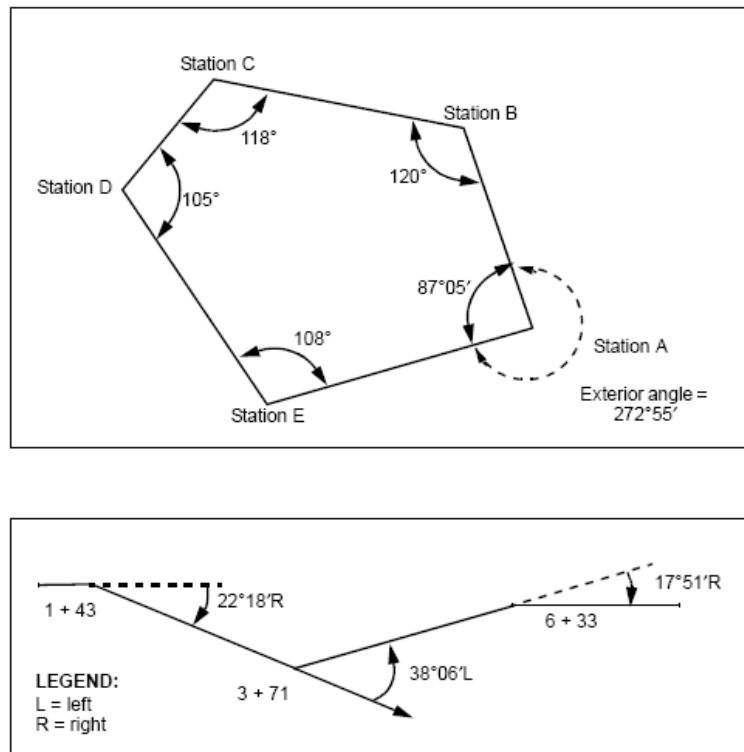

Figure 3-4. Interior angles on a closed traverse (top) and deflection angles on an open traverse (bottom) (FM 3-34.331)

example, a line with an azimuth of $341^{\circ} 12' 30''$ falls in the fourth or northwest (NW) quadrant and its bearing is $N 18^{\circ} 47' 30'' W$.

c. Azimuth types. The azimuth of a line is its direction as given by the angle between the meridian and the line, measured in a clockwise direction. Azimuths can be referenced from either the south point or the north point of a meridian. (Geodetic azimuths traditionally have been referenced to the south meridian whereas grid azimuths are referenced to the north meridian). Assumed azimuths are often used for making maps and performing traverses, and are determined in a clockwise direction from an assumed meridian. Assumed azimuths are sometimes referred to as "localized grid azimuths." Azimuths can be either observed or calculated. Calculated azimuths consist of adding to or subtracting field observed angles from a known bearing or azimuth to determine a new bearing or azimuth.

d. Azimuth determination guidelines. Azimuths will be determined as a line with a clockwise angle from the north or south end of a true or assumed meridian. For traverse work using angle points, the traverse closure requirements outlined in Chapter 4 will be followed.

e. Astronomic azimuth. In order to control the direction of a traverse, an astronomic azimuth must be observed at specified intervals and abrupt changes of direction of the traverse. Astronomic azimuth observations can be made by the well-known hour angle or altitude methods. Azimuth observations should be divided evenly between the backsight and foresight stations as reference objects. Using the rear station, turn clockwise to forward station then to star, reverse telescope on star, then forward station and back to rear station. Then using forward station, turn clockwise to rear station then to star, reverse telescope on star, then rear station and back to forward station. The number of position repetitions will depend upon the order of accuracy required. Since GPS has effectively eliminated the need for lengthy traverse networks, astronomic azimuth observations are rarely ever required. Exceptions may involve boundary surveys originally referenced from solar azimuth observations. Procedures for observing astronomic azimuths can be found in the references listed at Appendix A-2. (Note that GPS azimuths determined relative to WGS 84 must be corrected to the reference orientation of the local datum).

3-5. Electronic Distance Measurement

The distance between two points can be horizontal, slope, or vertical. A tape measure or an EDM device (such as a total station) can measure horizontal and slope distances. A distance measured on a slope can be trigonometrically converted to its horizontal equivalent by using the slope angle or vertical difference of elevation (DE). Figure 3-6 below illustrates a basic example of the geometry used to determine the horizontal distance of a measurement over uneven ground.

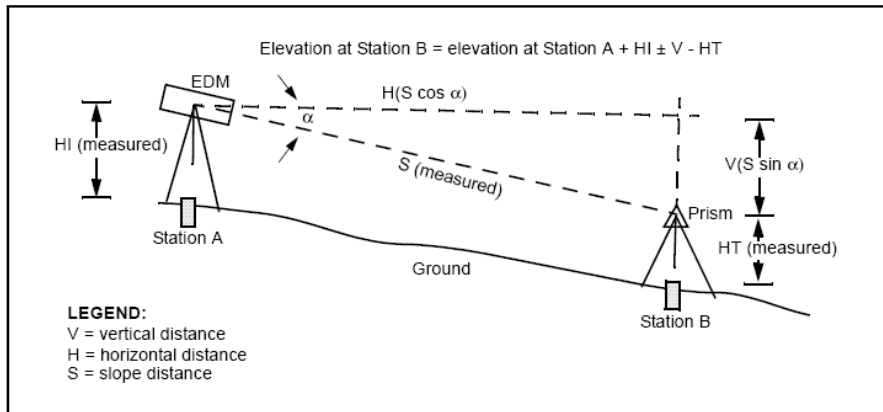

Figure 3-6. Geometry of an EDM measurement (FM 3-34.331)

Alternatively, the elevations of the occupied hubs (Stations A and B in Figure 3-6 above) may have been determined by differential levels. Applying the measured HI and HT yields the absolute elevation of the instrument and target. The measured slope distance "S" can then be reduced to a horizontal distance "H" given the delta elevation between the instrument and target. A meteorological correction is applied to the observed slope distance before reducing it to horizontal. Subsequently, the horizontal distance is corrected for grid scale and sea level. A traditional field book example of a horizontal slope distance observation is shown in Figure 3-7 below. In this example, slope distances are manually recorded along with meteorological data. A series of 10 slope distances were observed and averaged. A meteorological correction is applied along with a constant instrument/system constant. The resultant slope distance "T" (76.106 m) is reduced to horizontal, then to a grid distance (H_g in Figure 3-7). No sea level correction was applied since this project was set on an arbitrary datum (PICES). Note that Figure 3-7 illustrates the internal computations now automatically performed in a total station/data collector system.

R @ CFBC 992		# @ CFBC 993 (PICES)		27 JULY 1984	
MARK:	INSTRUMENT STAND	TRIPOD		INGLIS LOCK	
INST:	AGA #XXXXX	R/REF S/N XXXX		(FULL @ 36.3)	
ELEV	99.2198 m	97.6147 m		CLEAR	
PLUG INSERT	-0.0510	N/A		R NOLES	
HI (FV/m)	+0.226 (0.73)	+1.713 (5.62)		M BERGEN	
ELEV R	99.3948 m	# 99.3277 (PICES DATUM)		Φ BERGEN	
	0.0671 m	Δ ELEVATION		TIME 0847 AM	
SLOPE DISTANCE OBSERVATIONS					
SET 1	SET 2	TEMP (°F)	PRESS (inHg)	SLOPE → GRID REDUCTION	
72.1084 m	72.1086 m			T = 72.106 m	
" 1087	" 1087	R 86/87	30.12/30.15	Δe = 0.0671 m	
" 1081	" 1088	Φ 85/86		H = (T ² - Δe ²) ^{1/2}	
" 1083	" 1085			= 72.106 m	
72.1085	72.1083			(HORIZONTAL DIST)	
MEAN = 72.1084	72.1086	86°F	30.1 inHg	Scale Fctr. 0.9999743	
TOTAL MET CORR: ±16 ppm		Dialed in AGA		GRID DIST = H × SF	
MEAN (SETS) 72.108 m		(INCL 1 ppm Humidity Corr)		H _g = 72.104 m	
-0.002 m		SYSTEM CONSTANT (8 JUN 84 CALIB)			
T = 72.106 m		MET. CORRECTED SLOPE DISTANCE			

Figure 3-7. Horizontal distance observations and reductions--manual computations in field book (Jacksonville District)

a. *Errors.* Distances measured using an EDM are subject to the same errors as direction measuring equipment. The errors also include instrumental component errors. Instrumental errors are usually described as a number of millimeters plus a number of ppm. The accuracy of the infrared EDM is

The azimuth (or bearing) from A to B (α) is determined by reducing the observed azimuth to the relative quadrant. For example, in Figure 3-8, if the azimuth from Point A to the Azimuth Mark is 320° , and observed angle " β " from Station A between the reference azimuth point and Point B is 105° , then the azimuth of the line from Point A to Point B " α " is computed from:

$$\text{Azimuth } (\alpha) \text{ from A } \rightarrow \text{ B} = 105^\circ - (360^\circ - 320^\circ) = 65^\circ \text{ [or bearing N } 65^\circ \text{ E]}$$

The computation of the difference in northing (dN) and the difference in easting (dE) requires the computation of a right triangle. The distance from Station A to Station B (" s " in Figure 3-8--reduced to horizontal, sea level, corrected for grid scale, etc.) is the hypotenuse of the triangle, and the bearing angle (azimuth) is the known angle. The following formulas are used to compute dN and dE:

$$\begin{aligned} dN &= s \cdot \cos(\alpha) \\ dE &= s \cdot \sin(\alpha) \end{aligned} \quad (\text{Eq 3-1})$$

If the traverse leg falls in the first (northeast [NE]) quadrant, the value of the easting increases as the line goes east and the value of the northing increases as it goes north. The product of the dE and the dN are positive and are added to the easting and northing of Station A to obtain the coordinate of Station B, as shown in Figure 3-8. When using trigonometric calculators to compute a traverse, enter the azimuth angle, and the calculator will provide the correct sign of the function and the dN and the dE. If the functions are taken from tables, the computer provides the sign of the function based on the quadrant. Lines going north have positive dNs; lines going south have negative dNs. Lines going east have positive dEs; lines going west have negative dEs. The following are examples of how to compute the dN and the dE for different quadrants:

- Given an azimuth from Station A to Station B of $70^\circ 15' 15''$ and a distance of 568.78 meters (this falls in the first [NE] quadrant), compute the dN and the dE.

$$dN = \cos 70^\circ 15' 15'' \cdot 568.78 = +0.337848 \cdot 568.78 = +192.16 \text{ m}$$

$$dE = \sin 70^\circ 15' 15'' \cdot 568.78 = +0.941200 \cdot 568.78 = +535.34 \text{ m}$$

- Given an azimuth from Station B to Station C of $161^\circ 12' 30''$ and a distance of 548.74 meters (this falls in the second [southeast] [SE] quadrant), compute the dN and the dE.

$$dN = \cos 161^\circ 12' 30'' \cdot 548.74 = -0.946696 \cdot 548.74 = -519.49 \text{ m}$$

$$dE = \sin 161^\circ 12' 30'' \cdot 548.74 = +0.322128 \cdot 548.74 = +176.76 \text{ m}$$

- Given an azimuth from Station C to Station A of $294^\circ 40' 45''$ and a distance of 783.74 meters (this falls in the fourth [NW] quadrant), compute the dN and the dE.

$$dN = \cos 294^\circ 40' 45'' \cdot 783.74 = +0.417537 \cdot 783.74 = +327.24 \text{ m}$$

$$dE = \sin 294^\circ 40' 45'' \cdot 783.74 = -0.908660 \cdot 783.74 = -712.15 \text{ m}$$

3-7. Traverse Surveys

A traverse survey is defined as the measurement of the lengths and directions of a series of straight lines connecting a series of points on the earth. Points connected by the lines of a traverse are known as traverse stations. The measurements of the lengths and directions are used to compute the relative horizontal positions of these stations. Traversing is used for establishing basic area control where horizontal positions of the traverse stations, and elevations of the stations, must be determined. If reference azimuth marks or features are not available, astronomic observations and/or GPS-derived azimuths are made along a traverse at prescribed intervals to control the azimuth alignment of the traverse. The interval and type of controlling azimuth observation will depend upon the order of accuracy required and the traverse methods used; and the availability of existing control.

a. *Traverse types.* There are two basic types of traverses, namely, closed traverses and open traverses.

(1) Closed traverse. A traverse that starts and terminates at a station of known position is called a closed traverse. The order of accuracy of a closed traverse depends upon the accuracy of the starting and ending known positions and the survey methods used for the field measurements. There are two types of closed traverses.

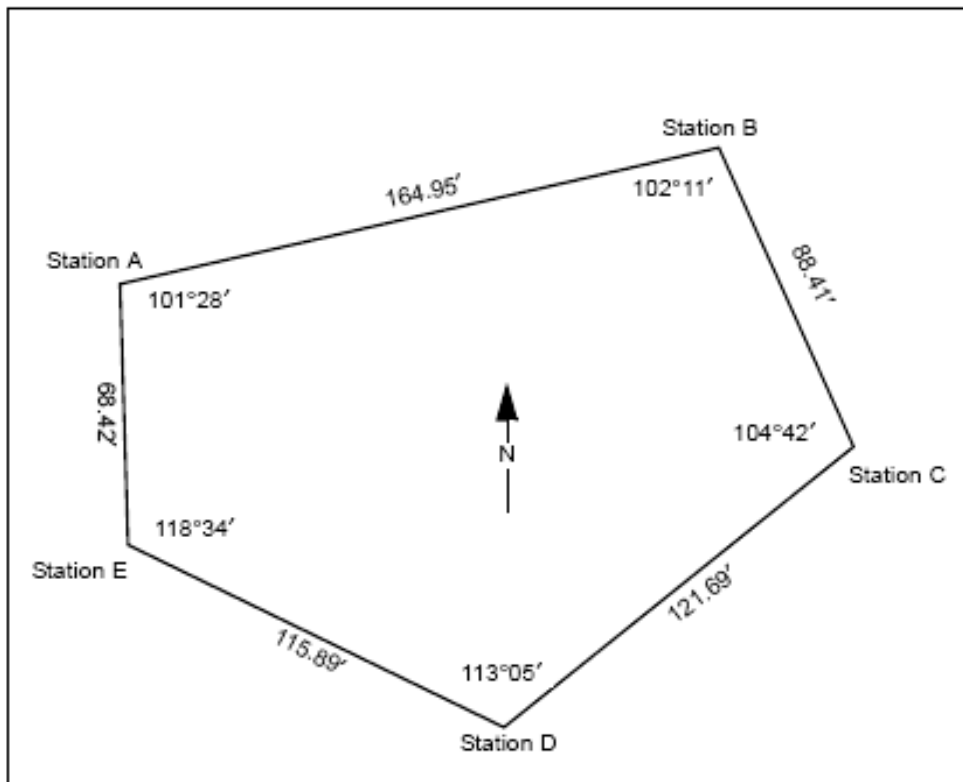

Figure 3-9. Closed Traverse--Looped (Station A fixed) or Connecting (Stations A and B fixed)

(a) Loop traverse. A loop traverse starts on a station of known position and terminates on the same station--e.g., Station A in Figure 3-9 above. An examination of the position misclosure in a loop traverse

will reveal measurement blunders and internal loop errors, but will not disclose systematic errors or external inaccuracies in the control point coordinates. In a loop traverse, the measured angular closure is the summation of the interior or exterior horizontal angles in the traverse. If there are "n" sides in a loop traverse, and interior angles were measured, the true angular closure should equal $(n-2) \cdot 180^\circ$. If exterior angles were measured when performing a loop traverse, the true angular closure should equal $(n+2) \cdot 180^\circ$. In Figure 3-9 above, the starting azimuth from Station "A" is not shown. This initial azimuth might have been taken from a GPS, magnetic, or astronomic observation--or even an arbitrary (assumed) value might have been used.

(b) Connecting traverse. A connecting traverse starts on a station of known position and terminates on a different station of known position. An example would be Stations "A" and "B" in Figure 3-9 above--if these two points have fixed coordinates (and azimuth A-B between them). When using this type of traverse, the systematic errors and position inaccuracies can be detected and eliminated along with blunders and accidental errors. The ability to correct measurement error depends on the known accuracy of the control point coordinates, and related azimuth references used at each end of the traverse.

(2) Open traverse. (Figure 3-10 below). An open traverse starts on a station of known position and terminates on a station of unknown position. With an open traverse, there are no checks to determine blunders, accidental errors, or systematic errors that may occur in the measurements. The open traverse is very seldom used in topographic surveying because a loop traverse can usually be accomplished with little added expense or effort.

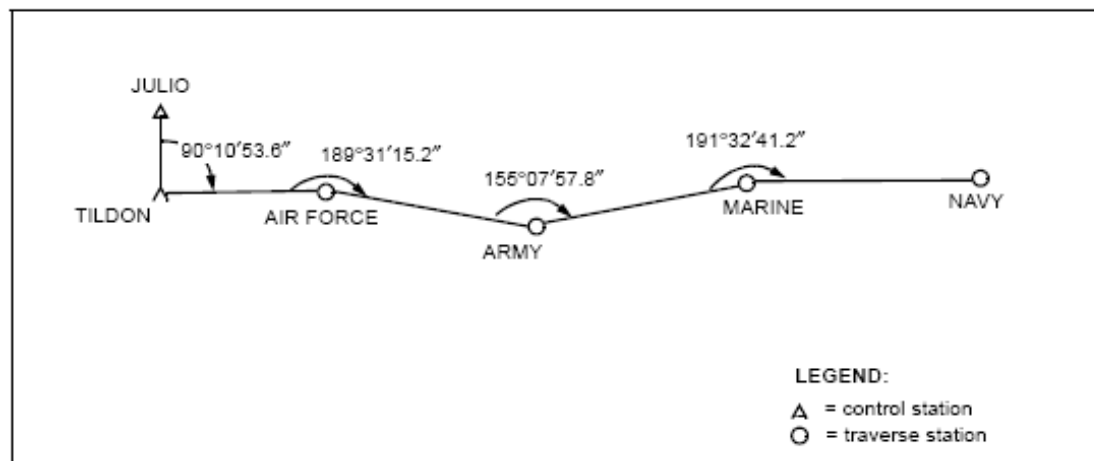

Figure 3-10. Open traverse

b. Right-of-way traverse. A right-of-way traverse normally starts and ends on known points. This type of traverse can be run with a transit and steel tape, EDM, or total station. The style of notes is similar to most traverses with the only difference being the type of detail shown. Fences can be of particular importance in determining right-of-way limits, especially when working in an area not monumented. Notes for right-of-way traverses should be especially clear and complete for many times this type of traverse is the basis for legal or court hearings regarding true property corners. If a search for a corner is made and nothing is found, a statement should be written in the field book to this effect. Property title searches and deed research will generally be required to obtain appropriate existing descriptions, plans, and other documents, which are generally available in the public record.

c. Stadia traverse. Uses of stadia traverses include rough or reconnaissance type surveys, checking on another traverse for errors, and control for a map being made by stadia methods on a very large scale. Stadia traverses are rarely performed given the availability of total stations today.

d. Compass traverse. A compass traverse is made to establish the direction of a line by magnetic compass measurements (i.e. no angles are turned). Distances are usually measured by stadia or paced. These types of surveys are rarely performed.

3-8. Traverse Survey Guidelines

Several basic steps are required to plan and execute a traverse survey:

- research existing control in the project area
- design survey to meet specifications
- determine types of measurements
- determine types of instruments
- determine field procedures
- site reconnaissance and approximate surveys
- install monuments and traverse stations
- data collection
- data reduction
- data adjustment
- prepare survey report

The following general guidelines are recommended in performing traverse surveys:

a. Preparation. For most applications, it is recommended that permanent points be established at intervals of one mile or less, starting at a known point--preferably a NGS published control point on the NSRS. Plan the traverse to follow a route that will be centered as much in the project area as possible, and avoiding areas that will be affected by construction, traffic, or other forms of congestion. The route should provide a check into other known points as often as practicable. After determining the route, it is best to set temporary or permanent monuments (e.g., wooden hubs, PK nails, iron rods, brass caps in concrete, or some other suitable monument) at each angle point on the traverse. Refer to EM 1110-1-1002 (*Survey Markers and Monumentation*) for further guidance. Ensure there is a clear line of sight from angle point to angle point and determine an organized numbering or naming system to mark all points when set.

b. Accuracy requirements. Control traverses are run for use in connection with all future surveys to be made in the area of consideration. They may be of Second, Third, or Fourth-Order accuracy, depending on project requirements. Most USACE project requirements will be satisfied with Second- or Third-Order accuracies. The order of accuracy for traversing may also be determined by the equipment and methods used to collect the traverse measurements, by the final accuracy attained, and by the coordinate accuracy of the starting and terminating stations of the traverse. The point closure standards indicated in Chapter 4 must be met for the appropriate accuracy classification to be achieved.

c. Position and azimuth orientation. If it is impossible to start or terminate on stations of known position and/or azimuth, then a GPS or astronomic observation for position and/or azimuth must be conducted. Astronomic position or azimuth observations are no longer practical given the ease of GPS for these requirements. Two GPS static points can be established at the ends of a traverse, from which a starting position and azimuth is available. The GPS azimuth point should be 500 to 1,000 ft distant from

the initial point. Extreme care should be taken not to mix up astronomic, geodetic, GPS, magnetic, and grid azimuths--they are all different.

d. Traverse route. The specific route of a new traverse should be selected with care, keeping in mind its primary purpose and the flexibility of its future use. Angle points should be set in protected locations if possible. Examples of protected locations include fence lines, under communication or power lines, near poles, or near any permanent concrete structure. It may be necessary to set critical points below the ground surface. If this is the case, reference the traverse point relative to permanent features by a sketch, as buried points are often difficult to recover at future dates. Select sites for traverse stations as the traverse progresses. Locate the stations in such a way that, at any one station, both the rear and forward stations are visible. The number of stations in a traverse should be kept to a minimum to reduce the accumulation of instrument errors and the amount of computing required. Short traverse legs (courses or sections) require the establishment and use of a greater number of stations and may cause excessive errors in the azimuth. Small errors in centering the instrument, in station-marking equipment, and in instrument pointings, can be magnified over short courses and can result in abnormally high azimuth closures.

e. Temporary hubs. Temporary station markers are usually 2x2-inch wooden hubs, 6 inches or more in length. These hubs should be driven flush with the ground, especially in maintained areas or where the hubs could present a hazard. The center of the top of the hub is marked with a surveyor's tack or an "X" to designate the exact point of reference for angular and linear measurements. To assist in recovering a station, a reference stake (e.g., a flagged 1 x 2 inch wood stake) may be set near the hub. The reference stake should be marked with the traverse station designation, stationing, offset, etc.--as applicable.

f. Measurements. Follow manufacturer instructions for operation of theodolites, EDM, or total stations. When using an EDM or total station, a minimum of two redundant readings should be made before moving to the next occupation point. Special care should be taken with the type of sights used for angle measurement--fixed rigid sights should be used, not hand held targets on poles. For directional theodolite or total station angle measurements, at least two sets (positions) of angles should be made. Always measure horizontal angles at the occupied station by sighting the instrument at the rear station and measuring the clockwise angles to the forward station. A horizon closure may be performed as a check.

g. Field data reductions. All survey field notes should be carefully and completely reduced; with the mean angle calculated in the field and recorded along with the sketch. All traverse adjustments should be made in the office unless this capability is available on the data collector in the field. A sketch of the permanent monument locations should be made in the field and a detailed description on how to recover them should be recorded in writing. This information can be used for making subsequent record of the survey monument and survey report. Refer to examples in FM 3-34.331. Temporary monuments need only be briefly described in the field notes

3-9. Traverse Computations and Adjustments

There are a number of methods available for adjusting traverses. The most common are listed below.

a. Crandall Rule. The Crandall rule is used when the angular measurements (directions) are believed to have greater precision than the linear measurements (distances). This method allows for the weighting of measurements and has properties similar to the method of least squares adjustment. Although the technique provides adequate results, it is seldom utilized because of its complexity. In addition, modern distance measuring equipment and electronic total stations provide distance and angular

measurements with roughly equal precision. Also, a standard Least Squares adjustment can be performed with the same amount of effort.

b. Compass Rule. The Compass Rule adjustment (also called the Bowditch Method) is used when the angular and linear measurements are of equal precision. This is the most widely used traverse adjustment method. Since the angular and linear precision are considered equivalent, the angular error is distributed equally throughout the traverse. For example, the sum of the interior angles of a five-sided traverse should equal $540^{\circ} 00' 00''.0$, but if the sum of the measured angles equals $540^{\circ} 01' 00''.0$, a value of $12''.0$ must be subtracted from each observed angle to balance the angles within traverse. After balancing the angular error, the linear error is computed by determining the sums of the north-south latitudes and east-west departures. The misclosure in latitude and departure is applied proportional to the distance of each line in the traverse.

c. Least Squares. The method of least squares is the procedure of adjusting a set of observations that constitute an over-determined model (redundancy > 0). A least squares adjustment relates the mathematical (functional model) and stochastic (stochastic model) processes that influence or affect the observations. Stochastic refers to the statistical nature of observations or measurements. The least squares principle relies on the condition that the sum of the squares of the residuals approaches a minimum.

$$v^t w v \rightarrow \text{minimum} \tag{Eq 3-2}$$

where

- v = observation residual
- w = weight of observation

The residuals (v) are the corrections to the observations. The final adjusted observations equal the observation plus the post-adjustment residual.

$$l^{\wedge} = l + v \tag{Eq 3-3}$$

where

- l^{\wedge} = adjusted observation
- l = observation
- v = observation residual

(1) Functional model. The functional model relates physical or geometrical conditions to a set of observations. For example, if a surveyor measures the interior angles of a five-sided figure, the sum of these angles should add up to 540° . If the correct model is not determined, the adjusted observations will be in error.

(2) Stochastic model. The stochastic model is the greatest advantage of the least squares procedure. In least squares adjustment, the surveyor can assign weights, variances, and covariance information to individual observations. The traditional traverse balancing techniques do not allow for this variability. Since observations are affected by various errors, it is essential that the proper statistical estimates be applied.

(3) Observations. Observations in least squares are the measurements that are to be adjusted. An adjustment is not warranted if the model is not over-determined (redundancy = 0). Observations vary due to blunders and random and systematic errors. When all blunders and systematic errors are removed from the observations, the adjustment provides the user an estimate of the “true” observation.

(4) Blunders. Blunders are the result of mistakes by the user or inadvertent equipment failure. For example, an observer may misread a level rod by a tenth of a foot or a malfunctioning data recorder may cause erroneous data storage. All blunders must be removed before the least squares adjustment procedure. Blunders can be identified by scrutinizing the data before they are input in the adjustment software. Preliminary procedures like loop closures, traverse balancing, and weighted means are techniques that can identify blunders before adjustment.

(5) Systematic errors. Systematic errors are the result of physical or mathematical principles. These errors must be removed before the adjustment procedure. Systematic errors are reduced or eliminated through careful measurement procedures. For example, when using a total station EDM, the user should correct the distance for meteorological effects (temperature, pressure, relative humidity).

(6) Random errors. Random errors are an unavoidable characteristic of the measurement process. The theories of probability are used to quantify random errors. The theory of least squares is developed under the assumption that only random errors exist within the data. If all systematic errors and blunders have been removed, the observations will differ only as the result of the random errors.

(7) References. Many field data collectors are capable of performing Least Squares traverse adjustments; thus, simple traverses are more frequently being adjusted by this method. Least squares adjustment techniques are covered in detail in EM 1110-1-1003 (*NAVSTAR Global Positioning System Surveying*) and EM 1110-2-1009 (*Structural Deformation Surveying*).

3-10. Traverse Adjustment (Compass Rule)

The Compass Rule is a simple method and is most commonly employed for engineering, construction, and boundary surveys. It is also recognized as the accepted adjustment method in some state minimum technical standards. The following sections only briefly describe traverse adjustment techniques--detailed procedures and examples of traverse adjustments can be found in any of the texts listed in Appendix A-2.

a. General. Traverse computations and adjustments require the following steps (Wolf and Brinker 1994):

- Adjust angles and directions to fixed geometric conditions based on angular misclosure
- Calculate latitudes (dY or dN) and departures (dX or dE) of the traverse misclosure
- Distribute the misclosure latitudes and departures over the traverse
- Compute adjusted coordinates of the traverse stations
- Calculate final adjusted lengths and azimuths between traverse points

b. Angle computations and adjustments. The azimuth of a line is the horizontal angle (measured clockwise) from a base direction to the line in question. To compute a traverse, surveyors determine the azimuth for each traverse leg, starting with the fixed azimuth at the known starting point. This fixed azimuth is typically that computed between the fixed starting station and some azimuth reference point (another monument, a known object, or astronomical), as was shown back on Figure 3-8. The azimuth for each succeeding leg is then determined by adding the value of the measured angle at the occupied station to the value of the azimuth from the occupied station to the rear station. On occupation of each successive station, the first step is to compute the back azimuth of the preceding leg (the azimuth from the occupied station to the rear station). At the closing station, the azimuth carried forward is compared with the computed azimuth from the closing station to the reference azimuth mark.

(1) Azimuth correction. The azimuth closure error is obtained by subtracting the known closing azimuth from the computed closing azimuth, as described above. This difference provides the angular closure error with the appropriate sign. By reversing this sign, the azimuth correction (with the appropriate sign) is obtained. If the angular error of closure is less than the allowable angular error of closure for the order of traverse (see closure standards in Chapter 4), the azimuths of the traverse may be adjusted. If the azimuth error is larger than the allowable closure error, then reobservations may be necessary. The allowable error of closure (or misclosure) depends on the instrument, the number of traverse stations, and the order of the control survey.

$$\text{Allowable error of closure} = K \cdot \sqrt{n} \tag{Eq 3-4}$$

where,

K = fraction of the least count of the instrument, dependent on the number of repetitions and accuracy desired (e.g., 20" for Third-Order and 60" for Fourth-Order--see Table 4-1 in Chapter 4)

n = number of traverse stations

(2) Azimuth adjustment. The Compass Rule is based on the assumption that angular errors have accumulated gradually and systematically throughout the traverse. The angular correction is then distributed systematically (equally) among the angles in the traverse. Refer to the "Balanced Angle" column in the example at Figure 3-11 below where a 4-second misclosure was distributed equally.

c. Traverse position computations. After the angles are adjusted as described above, compute the adjusted azimuth (or bearing) of each leg by using the starting azimuth and the adjusted angles at each traverse station. Verify the computed closing azimuth agrees with the computed fixed closing azimuth. Using the adjusted azimuths (or bearings) for each leg, and the measured distances (as corrected to sea level and grid scale), compute each traverse station X-Y (or N-E or departure-latitude) position from the beginning to the closing station--e.g., the "Unadjusted Latitudes and Departures" column in Figure 3-11. The linear misclosure at the closing station is determined in both X (departure or easting) and Y (latitude or northing) coordinates-- ΔX and ΔY . The overall position misclosure ($\sqrt{[\Delta X^2 + \Delta Y^2]}$) is then used to determine the relative accuracy (or precision) of the traverse, and conformance with the minimum closure standards in Table 4-1. The relative accuracy is obtained by dividing the misclosure (as computed after adjusting the angles) by the sum of the overall traverse length. This value is then inverted to obtain a ratio for comparison with Table 4-1, as shown in Equation 3-5 below.

$$\text{Relative accuracy (or precision)} = \frac{1}{[\text{Misclosure (after angular adjustment)} \div \Sigma \text{ of the traverse course distances}]^{-1}} \tag{Eq 3-5}$$

The sample traverse shown in Figure 3-11 below resulted in a misclosure of 0.036 ft over full 603.1ft traverse length. The relative accuracy is then:

$$0.036 \div 603.1 \approx 1 / 17,000 \text{ (i.e., "1 part in 17,000" or 1:17,000)}$$

The position misclosure (after azimuth adjustment) can then be distributed among the intermediate traverse station based on the adjustment rule being applied. For the Compass Rule, the latitude and departure misclosures are adjusted in proportion to the length of each traverse course divided by the overall traverse length. For any traverse leg with length dX (departure) and dY (latitude) in each coordinate, and with a final misclosure after azimuth adjustment of " ΔX " and " ΔY ", the corrections to the dX or dY lengths are adjusted by:

$$\text{Correction in } dX \text{ or } dY = \frac{-(\text{Misclosure } \Delta X \text{ or } \Delta Y) \cdot (\text{Length of Traverse Course})}{(\text{Overall Traverse Length})} \quad (\text{Eq 3-6})$$

Once the above corrections are applied to the latitudes and departures in each traverse course, the adjusted length and direction of each course can be computed, along with the final adjusted coordinates of each intermediate point. (These final computations are not shown in Figure 3-11).

d. Adjustment techniques. In the past, the above adjustment was performed using a tabular form that was laid out to facilitate hand calculation of the angular and coordinate corrections and adjustments--see sample at Figure 3-11 below. Other examples of Compass Rule traverse adjustments can be found in the references listed at Appendix A. Today, COGO software packages can perform this adjustment in the field or office and these tabular computation forms are not necessarily needed.

Compass Rule Adjustment											
Station	Measured Angle	Balanced Angle	Azimuth	Horiz. Distance	Unadjusted		Adjusted		Coordinates		Adjusted
					Latitude	Depart	Latitude	Depart			Length
12			103°-03'-14"	110.84'							
11	85°-05'-33"	85°-05'-34"	188°-03'-48"	219.51'	-217.29'	-31.11'	-217.30'	-31.12'			
9'	58°-48'-39"	58°-48'-40"	66°-57'-28"	130.05'	50.90'	119.67'	50.90'	119.66'			
13'	120°-52'-29"	120°-52'-30"	7°-49'-58"	142.70'	141.37'	19.45'	141.36'	19.44'			
12	95°-13'-15"	95°-13'-16"	288°-03'-14"	110.84'	25.04'	-107.98'	25.04'	-107.98'			
		$\Sigma = 360^\circ$									
$\Sigma \alpha_m =$	359°-59'-56"										
$\alpha_1 =$	360°										
$\alpha_n =$	-4"										
			D =	Σl_i	$\Sigma \Delta N_m$	$\Sigma \Delta E_m$	$\Sigma \Delta N$	$\Sigma \Delta E$			
			SUM	603.10'	0.02'	0.03'	0	0			
(p) Line of closure = 0.036'		Area = 20,081		Square Feet							
(P) Precision = 1/16,726		Area = 0.46		Acres							
Adjustment by BAF		Rule COMPASS RULE									
(p) Line of closure		$\left(\rho = \sqrt{\Sigma N_m^2 + \Sigma E_m^2} \right)$									
(P) Traverse precision		$\left(\frac{P}{D} \right)$									

Figure 3-11. Tabular computation format for a Compass Rule traverse adjustment

3-11. Triangulation and Trilateration Surveys

Triangulation and trilateration methods are now rarely used for expanding or densifying horizontal control. Before GPS, they were extensively used for this purpose. In USACE, localized triangulation and trilateration techniques (using Wild T3s and precise EDM) are still used for accurate structural deformation monitoring work. However, these specialized surveys are only performed around a lock,

dam, or hydropower project. Procedures and techniques for deformation triangulation/trilateration surveys are found in EM 1110-2-1009 (*Structural Deformation Surveying*).

a. General. A triangulation network consists of a series of angle measurements that form joined or overlapping triangles in which an occasional baseline distance is measured. The sides of the network are calculated from angles measured at the vertices of the triangle. A trilateration network consists of a series of distance measurements that form joined or overlapped triangles where all the sides of the triangles and only enough angles and directions to establish azimuth are determined.

b. Networks. When practicable, all triangulation and trilateration networks should originate from and tie into existing coordinate control of equal or higher accuracy than the work to be performed. An exception to this would be when performing triangulation or trilateration across a river or some obstacle as part of a chained traverse. In this case, a local baseline should be set. Triangulation and trilateration surveys should have adequate redundancy and are usually adjusted using least squares methods.

c. Accuracy. Point closure standards listed in Chapter 4 must be met for the appropriate accuracy classification to be achieved. If project requirements are higher-order, refer also to the FGCS "*Standards and Specifications for Geodetic Control Networks*" (FGCS 1984).

d. Resection. Three-point resection is a form of triangulation. Three-point resection may be used in areas where existing control points cannot be occupied or when the work does not warrant the time and cost of occupying each station. Triangulation of this type should be considered Fourth-Order, although Third-Order accuracy can be obtained if a strong triangular figure is used and the angles are accurately measured. The following minimum guidelines should be followed when performing a three-point resection:

(1) Location. Points for observation should be selected to give strong geometric figures, such as with angles between 60 and 120 degrees of arc.

(2) Redundancy. If it is possible to sight more than three control points, the extra points should be included in the figure. If possible, occupy one of the control stations as a check on the computations and to increase the positioning accuracy. Occupation of a control station is especially important if it serves as a control of the bearing or direction of a line for a traverse that originates from this same point.

(3) Measurements. Both the interior and exterior angles should be observed and recorded. The sum of these angles should not vary by more than three (3) arc-seconds per angle from 360 degrees. Each angle should be turned not less than 2-4 times (in direct and inverted positions).

SECTION II Vertical Control Survey Techniques

3-12. General

Vertical control surveys provide a basic framework for controlling elevations on facility mapping projects. The purpose of vertical control surveys is to establish elevations on rigid benchmarks throughout the project area. These benchmarks can then serve as points of departure and closure for leveling operations and as reference benchmarks during subsequent construction work. The NGS, USGS, other Federal agencies, and many USACE commands have established vertical control throughout the CONUS. Unless otherwise directed, these benchmarks should be used as a basis for all vertical control surveys. Descriptions of benchmark data and their published elevation values can be found in data holdings issued by the agency maintaining the project/installation. Information on USACE maintained points can be found at District or Division offices. This section focuses on Second-Order and Third-Order vertical control techniques performed using differential leveling instruments--Figure 3-12 below.



Figure 3-12. Sokkia B20 automatic level (Key West Harbor Dredging Project 2004--
C & C Technologies, Inc. & Jacksonville District)

a. Differential leveling. With differential leveling, differences in elevation are measured with respect to a horizontal line of sight established by the leveling instrument. Once the instrument is leveled (using either a spirit bubble or automated compensator), its line of sight lies in a horizontal plane. Leveling comprises a determination of the difference in height between a known elevation and the instrument and the difference in height from the instrument to an unknown point by measuring the vertical distance with a precise or semi-precise level and leveling rods (Figure 3-13). Digital (or Bar Code) levels are used to automatically measure, store, and compute heights, and are capable of achieving Second-Order or higher accuracies. Accuracy standards should follow the point closure standards shown in Table 4-2 in Chapter 4. When leveling in remote areas where the density of basic vertical control is scarce, the semi-precise rod is generally used. The semi-precise rod should be graduated on the face to centimeters and the back to half-foot intervals. When leveling in urban areas or areas with a high density of vertical control where ties to higher-order control are readily available, the standard leveling rods are used--e.g., a Philadelphia rod graduated to hundredths of a foot. Other rods that are graduated to centimeters can be used. Both types of rods are furnished with targets and verniers that will permit reading of the scale to millimeters or thousandths of a foot if required by specifications. This is generally not required on lower-order level lines. Standard stadia rods may also be used for lower-order level lines. The stadia rod is graduated to the nearest 0.05 ft, or two centimeters. These rods are generally equipped with targets or verniers, but if project specifications require, they can be estimated to hundredths of a foot.

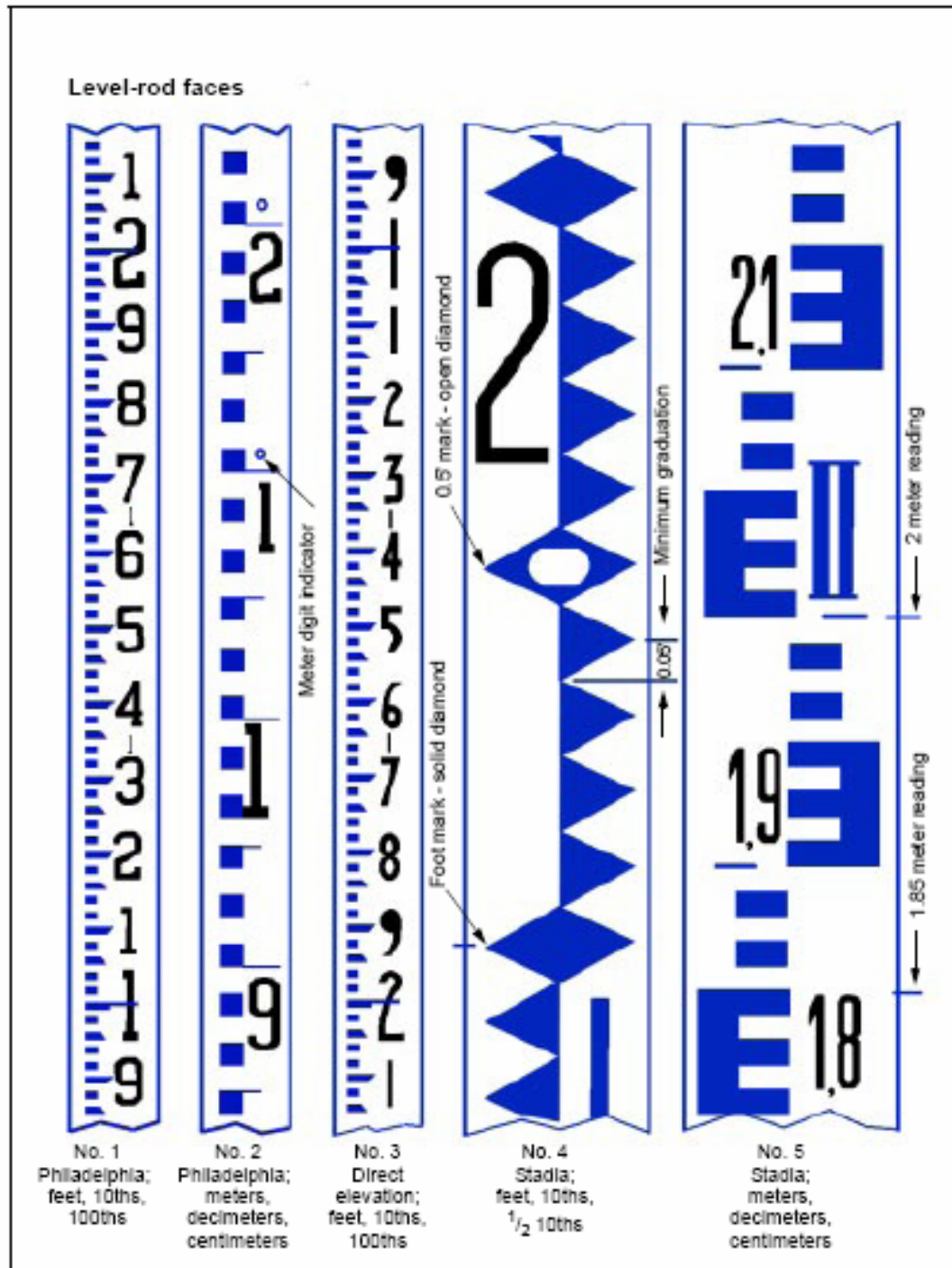

Figure 3-13. Traditional rectangular cross-section leveling rods showing a variety of graduation markings (FM 3-34.331)

b. Trigonometric leveling. This method applies the fundamentals of trigonometry to determine the differences in elevation between two points by observing a horizontal distance and the vertical angles above or below a horizontal plane. Trigonometric leveling is generally used for lower-order accuracy vertical positioning; however, it is sufficiently accurate for radial topography when elevations of features are cut in by a total station. Trigonometric leveling is especially effective in establishing control for

profile lines, for strip photography, and in areas where the landscape is steep. With trigonometric leveling operations, it is necessary to measure the height of instrument (HI) and rod target above the monuments, the slope distance (s), the vertical angle (a), and the rod intercept. From this data, the vertical difference in elevation (DE) can be computed using the sine of the vertical angle and applying the rod difference (Figure 3-14 below). Refinements to this technique include doubling vertical angles, taking differences from both stations, and using the mean values. If the horizontal distance is known between the instrument and the rod, it is not necessary to determine the slope distance. The instrument most commonly used for trigonometric leveling is a directional theodolite or Total Station. Manufacturer specifications and procedures should be followed to achieve the desired point closure standards.

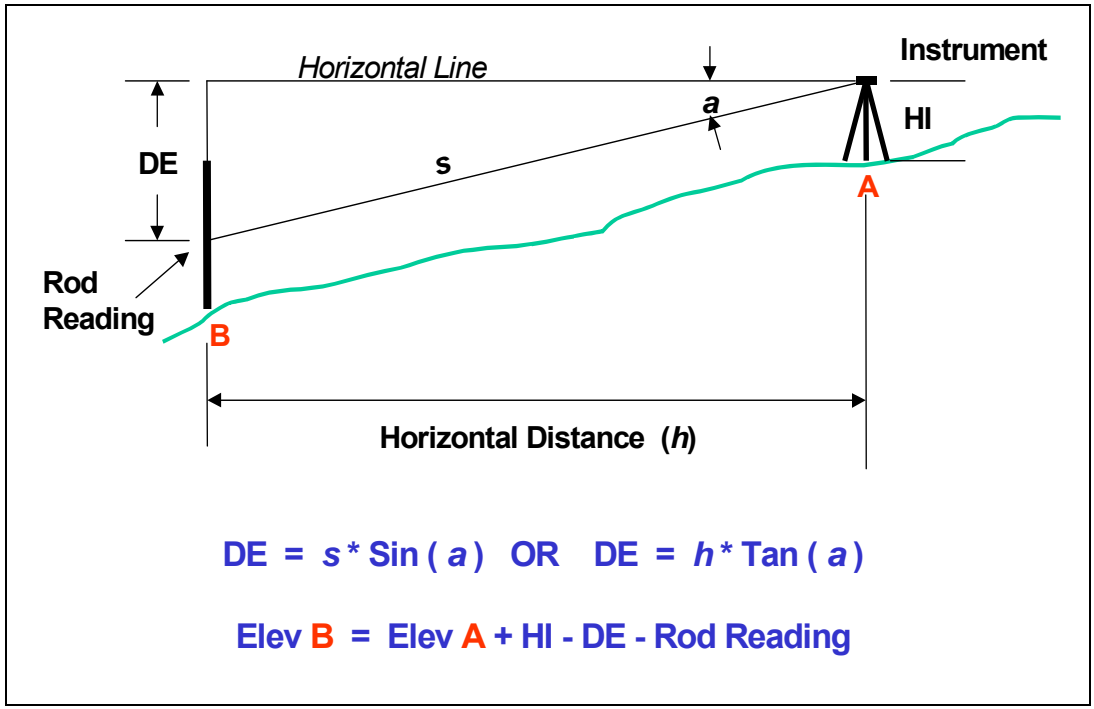

Figure 3-14. Trigonometric leveling

(1) Recording vertical trigonometric observations (zenith distances--ZD) is the same for all orders of accuracy. Vertical observations may be recorded in a standard field book, on DA Form 5817-R (*Zenith Distance/Vertical Angle*--see FM 3-34.331), on an equivalent single-sheet recording form, or a data collector. In all cases, complete documentation will be performed in the field. The following information is typically required:

- The HI above the station (recorded to the nearest 0.01 meter or foot).
- A sketch of the observed target (that shows the point observed on the target) at the bottom of the object-observed column.
 - The height of the observed rod reading (height of target--HT) above the station being observed (recorded to the nearest 0.01 meter or foot).
 - A sketch showing any target's adjoining stations. This sketch should be drawn in the bottom of the remarks column. All possible points that may be observed should be measured and recorded to the nearest 0.01 meter or foot.

(2) During vertical observations, the time of the first observation of the first position and the time of the last observation of the last position are recorded. The times are recorded to the nearest whole minute.

(3) Vertical observations may alternatively be abstracted onto DA Form 1943 (*Abstract of Zenith Distances*--see FM 3-34.331) at the station site by the observing party. Vertical observations recorded as vertical angles are converted to ZDs before abstracting. Targets or signals shown to other stations are sketched and dimensioned at the bottom of the form. If a target or signal is changed during the day, the time of the change and the new dimensions are also entered.

c. Trigonometric elevations over longer lines. Trigonometric elevations over longer lines may need to be corrected for curvature and refraction. These corrections are insignificant (< 0.02 ft) and unnecessary for topographic survey distances of 1,000 feet or less. The type of correction used depends on whether the long line was occupied at each end. The following formula (Wolf and Brinker 1994) is used to determine the combined curvature and refraction correction for trigonometric elevations observed over longer lines.

$$h \text{ (feet)} = 0.0206 (F)^2 \tag{Eq 3-7}$$

where

h = combined correction for curvature and refraction in feet
 F = length of observed line in thousands of feet

As an example, given a 2,000 ft line, the combined correction would be $0.0206 (2)^2 = 0.08$ ft, or about 0.1 ft. For longer lines, these approximate computations are not accurate; however, there are few applications requiring trigonometric leveling over longer lines given GPS methods will yield more accurate results. If long-line trigonometric leveling is required, consult the NOAA/NGS for more accurate observing procedures and computations.

d. Barometric leveling. This method uses the differences in atmospheric pressure as observed with a barometer or altimeter to determine the differences in elevation between points. This method is the least accurate of determining elevations. Because of the lower achievable accuracies, this method should only be used when other methods are not feasible or would involve great expense. Generally, this method is used for elevations when the map scale is to be 1:250,000 or smaller.

e. Reciprocal leveling (Valley or River Crossings). Reciprocal leveling is a method of carrying a level circuit across an area over which it is impossible to run regular differential levels with balanced sights (Figure 3-15). Most level operations require a line of sight to be less than 300 or 400 feet long. However, it may be necessary to shoot 500-1,000 feet, or even further, in order to span across a river, canyon, or other obstacle. Where such spans must be traversed, reciprocal leveling is appropriate. The reciprocal leveling procedure can be described as follows. Assume points "A" and "B" are turns on opposite sides of the obstacle to be spanned (Figure 3-15) where points A and B are intervisible. Two calibrated rods are used, one at point A, and the other at point B. With the instrument near A, read rod at A, then turn to B and have target set as close as possible and determine the difference in elevation. Leaving rods at A and B, move the instrument around to point B, read B, then turn to read A and again determine the difference in elevation. The mean of the two results is the final height difference to be applied to the elevation of A to get an elevation value for point B. If the long sight is difficult to determine, it is suggested that a target be used and the observations repeated several times to determine an average value. For more precise results it will be necessary to take several foresights, depending on the length of the sight. It is typical to take as many as 20 to 30 sightings. When taking this many sightings, it is critical to relevel the instrument and reset the target after each observation. Reciprocal leveling

assumes the conditions during the survey do not change significantly for the two positions of the level. Reciprocal leveling with two instruments should never be done unless both instruments are used on both sides of the obstacle and the mean result of both sets used. The use of two instruments is advised if it is a long trip around the obstacle. Reciprocal leveling is effective only if the instruments used will yield measurements of similar precision.

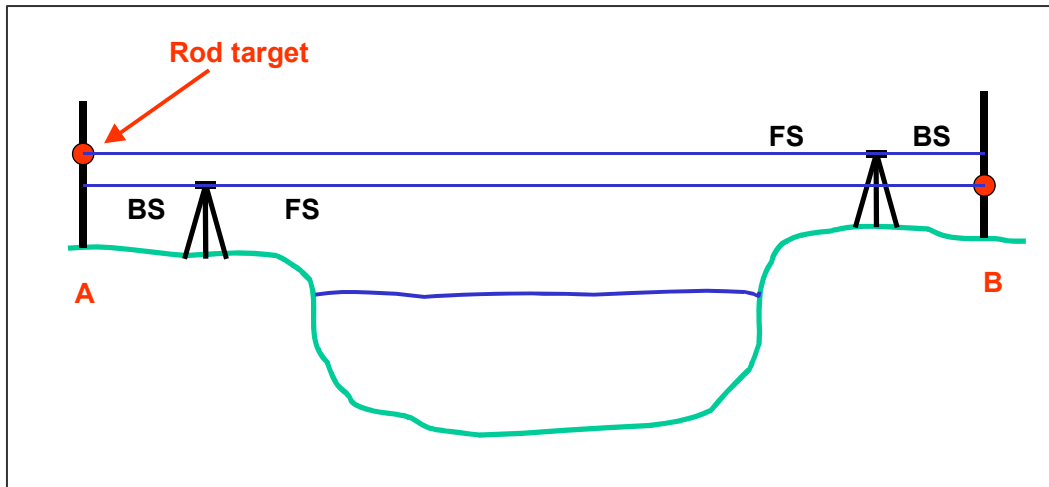

Figure 3-15. Reciprocal leveling for river crossing

f. Two rod leveling. In order to increase the productivity in precise leveling operations, it is advisable to use two rods. When the observations are completed at any instrument setup, the rods and the instruments are moved forward simultaneously. An even number of setups should be used to minimize the possible effects of rod index error. Two rods are recommended when using an automatic level, as this takes full advantage of the productivity possible with this type of instrument.

g. Tidal benchmarks and datums. For guidance on the establishment of tidal benchmarks and datums refer to Appendix B (*Requirements and Procedures for Referencing Coastal Navigation Projects to Mean Lower Low Water (MLLW) Datum*) and EM 1110-2-1003 (*Hydrographic Surveying*).

3-13. Second-Order Leveling

a. General. As shown in Figure 3-16 below, a leveling operation consists of holding a rod vertically on a point of known elevation. A level reading is then made through the telescope to the rod, known as a backsight (BS), which gives the vertical distance from the ground elevation to the line of sight. By adding this backsight reading to the known elevation, the line of sight elevation, called "height of instrument" (HI), is determined. Another rod is placed on a point of unknown elevation, and a foresight (FS) reading is taken. By subtracting the FS reading from the height of instrument, the elevation of the new point is established. After the foresight is completed, the rod remains on that point and the instrument and back rod are moved to forward positions. The instrument is set up approximately midway between the old and new rod positions. The new sighting on the back rod is a backsight for a new HI, and the sighting on the front rod is a FS for a new elevation. The points on which the rods are held for foresights and backsights are called "turning points." Other foresights made to points not along the main line are known as "sideshots." This procedure is used as many times as necessary to transfer a point of known elevation to another distant point of unknown elevation.

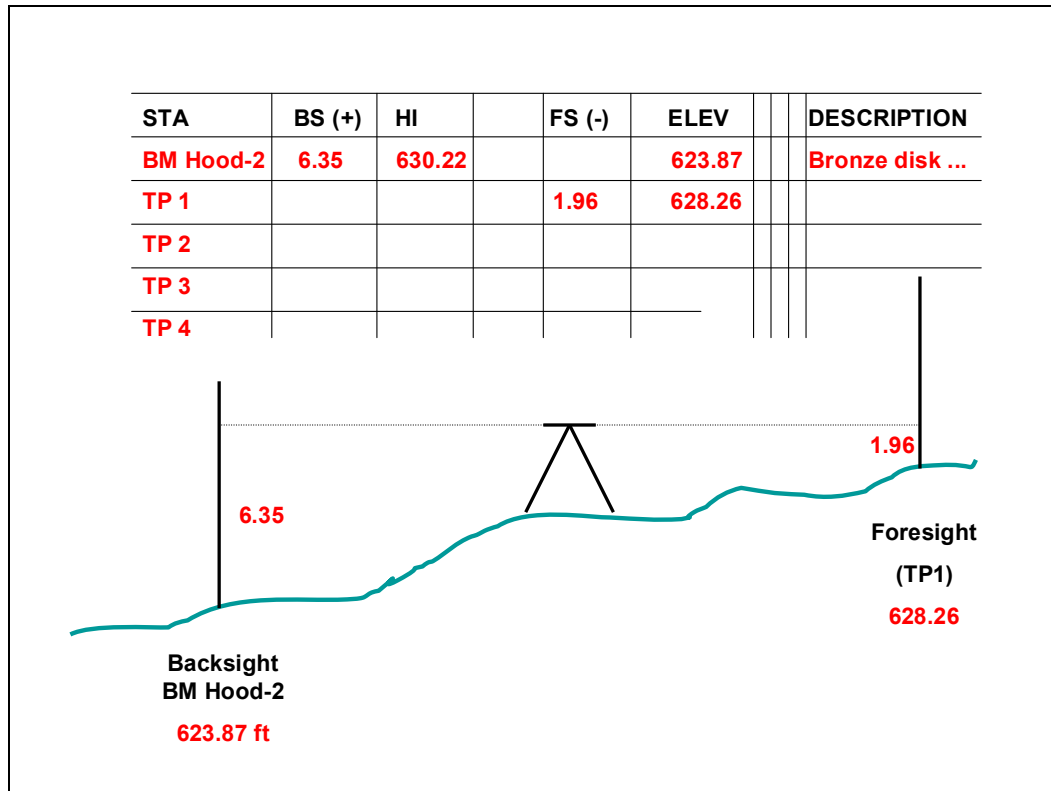

Figure 3-16. Differential leveling--example of one setup between benchmark and TP 1 (Standard field book recording format shown at top of sketch)

b. Leveling accuracy. Second-Order leveling point closure standards for vertical control surveys are shown in Table 4-2. Second-Order leveling consists of lines run in only one direction, and between benchmarks previously established by First-Order methods. If not checking into another line, the return for Second-Order--Class I level work should check within the limits of 0.025 times the square root of M feet (where "M" is the length of the level line in miles), while for Second-Order Class II work, it should check within the limits of 0.035 times the square root of M feet. Ties to two or more benchmarks are always recommended in order to verify stability of the fixed benchmarks.

c. Leveling equipment. The type of equipment needed is dependent on the accuracy requirements. Examples of precise leveling instruments are shown in Figure 3-17 below.

(1) Second-Order leveling instrument. Second-Order leveling instruments require a relatively precise level. Often a graduated parallel plate micrometer is built into the instrument to allow reading to the nearest 0.001 of a unit. The sensitivity of the level vial, telescopic power, focusing distance, and size of the objective lens are factors in determining the precision of the instrument. Instruments are rated and tested according to their ability to maintain the specified order of accuracy. Only those rated as precise geodetic quality instruments may be used for Second-Order work.

(2) Precise level rods. Precise level rods are normally used when running Second-Order levels. Both traditional rods and bar code type rods may be used. The rods may be of one piece, invar strip type, with the least graduation on the invar strip of 1 centimeter. The front of the rod is graduated in meters, decimeters and centimeters on the invar strip. The back of the rod is graduated in feet and tenths of feet, or yards and tenths of yards. Rods with similar characteristics are paired and marked. The pairings must be maintained throughout a line of levels. The invar strips should be checked periodically against a

standard to determine any changes that may affect their accuracy. The precise level rod is a scientific instrument and must be treated as such; not only during use but also during storage and transporting. When not in use they must be stored in their shipping containers to avoid damage. The footpiece should be inspected frequently to make sure it has not been bent or otherwise damaged.

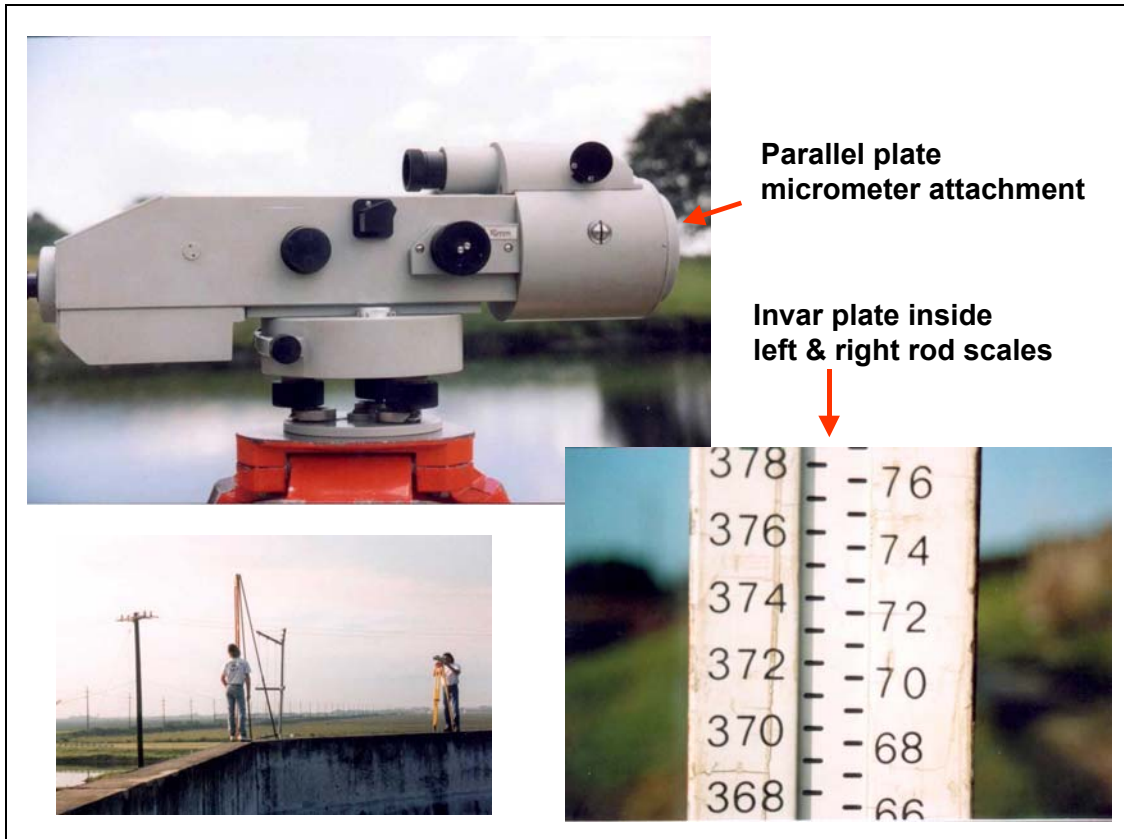

Figure 3-17. Zeiss Ni1 automatic level with parallel plate micrometer attached--precise double-scale Invar rod with constant 3.01550-meter difference in left and right scales (Jacksonville District)

d. Leveling monumentation. All benchmarks used to monument Second-Order level lines should conform to criteria published in EM 1110-1-1002 (*Survey Markers and Monumentation*). Benchmarks used to monument Second-Order level lines should be standard USACE brass caps set in concrete. The concrete should be placed in holes deep enough to avoid local disturbance. If the brass cap is not attached to an iron pipe, use some type of metal to reinforce the concrete prior to embedding the brass cap. Concrete should be placed in a protected position. If possible, benchmarks should be set close to a fence line, yet far enough away to permit plumbing of level rod. Do not set monuments closer than four feet to a fence post, as the benchmark likely will be disturbed if the post is replaced. Each brass cap must be stamped to identify it by the methods detailed in EM 1110-1-1002. In addition to stamping a local number or name on the cap, it is optional to stamp the elevation on the brass cap after final elevation adjustment has been made. The benchmarks must be set no less than 24 hours in advance of the level crew if the survey is to be made immediately after monument construction.

e. Leveling notes. Notes for Second-Order levels should be kept in a format approved by the District, or should follow recognized industry practice. A set style cannot be developed due to different types of equipment that may be employed. Elevations generally should not be carried in the field as they

will be adjusted by the field office and closures approved prior to assigning a final adjusted elevation. See the following section on Third-Order leveling for sample recording formats and sketches.

f. Three-wire leveling. This method can be used for most types of leveling work and will achieve any practical level of accuracy, including Second-Order. However, most applications do not require the accuracies possible with three-wire leveling; plus, it is somewhat labor intensive. Three-wire leveling can be applied if the reticule of the level has stadia lines and substadia that are spaced so that the stadia intercept is 0.3 ft at 100 feet, rather than the more typical 1.0 ft at 100 feet. The substadia lines in instruments meant for three-wire leveling are short cross lines that cannot be mistaken for the long central line used for ordinary leveling. Although there are many different observing techniques for three-wire leveling, in the following example, the rod is read at each of the three lines and the average is used for the final result. Before each reading, the level bubble is centered. The half-stadia intervals are compared to check for blunders. The following values were taken and recorded and calculations made:

Upper Wire:	8.698	2.155 :Upper Interval
Middle Wire:	6.543	
<u>Lower Wire:</u>	<u>4.392</u>	2.151 :Lower Interval
Sum	19.633	
Average	6.544	

The final rod reading would be 6.544 feet. The upper and lower intercepts differ by only 0.004 ft--an acceptable error for this sort of leveling and evidence that no blunder has been made. It is recommended that "Yard Rods" specifically designed for three-wire leveling operations be used instead of Philadelphia rods that are designed for ordinary leveling. A sample recording form is shown at Figure 3-18.

c. Leveling equipment. The type of equipment needed is dependent upon the accuracy requirements.

(1) Third-Order level. A semi-precise level can be used for Third-Order leveling, such as the tilting Dumpy type, three-wire reticule, or equivalent.

(2) Leveling rods. The rods should be graduated in feet, tenths and hundreds of feet. The Philadelphia rod or its equivalent is acceptable. However, the project specifications will sometimes require that semi-precise rods be used that are graduated on the front in centimeters and on the back in half-foot intervals. The Zeiss stadia rod, fold type, or its equivalent should be used when the specifications require semi-precise rods.

(3) Lower-order instruments. The type of spirit level instrument used should ensure accuracy in keeping with required control point accuracy. Precision levels are not required on lower-order leveling work. The Fennel tilting level, dumpy level, Wye level, or their equivalent, are examples of levels that can be used. A stadia rod with least readings of 0.05 ft or 1 cm will be satisfactory. The use of turning pins and/or plates will depend upon the type of terrain or if rods may be placed on firm stones or roadways.

d. Leveling monumentation. The level line should be tied to all existing benchmarks along or adjacent to the line section being run. In the event there are no existing benchmarks near the survey, new ones should be set, not more than 0.5 mile apart. Steep landscape in the area of survey may require monuments to be set at a closer spacing. Benchmarks should be set on permanent structures, such as, head walls, bridge abutments, pipes, etc. Large spikes driven into the base of trees, telephone poles, and fence posts are acceptable for this level of work. All temporary benchmarks must have a full description including location. Unless they are on a turn, they are not considered temporary benchmarks. No closures shown by an intermediate shot will be accepted. All temporary benchmarks must have a name or number for future identification.

e. Leveling equipment. Turning pins should be driven into in the ground until rigid with no possibility of movement. Turning points or temporary benchmarks will have a definite high point so that any person not familiar with the point will automatically hold the rod on the highest point, and so that it can spin free. If solid rocks are being used for turns they must be marked with crayon or paint prior to taking readings. It is not mandatory to use targets on the rod when the reading is clearly visible. However, they are required in dense brush, when using grade rods, or when unusually long shots are necessary. Rod bubbles should always be used to ensure the rod is held plumb.

f. Leveling notes and sketches. Complete notations or sketches should be made to identify level lines and side shots. All Second- and Third-Order or lower level notes should be completely reduced in the field as the levels are run; with the error of closure noted at all tie in points. In practice, the circuit will be corrected to true at each tie in point unless instructed to do otherwise by the survey supervisor or written directive. Any change in rod reading should be initialed and dated so there is no doubt as to when a correction was made. Cross out erroneous readings--never erase them. The instrument man should take care to keep peg notes on all turns in the standard field book. The notes should be dated and noted as to what line is being run, station occupied, identification of turns, etc. A complete description of each point on which an elevation is established should be recorded in the field book adjacent to the station designation. Entries should be made in the book that give the references to the traverse notes and other existing data used for elevations (e.g., TRAVERSE BOOK XXXX PAGE XX, USGS Quad XXXXXX, NOS Chart XXXX, etc.). Level notes should conform to a standard industry format, e.g., Point--(+)BS--HI--(-)FS--Elev. In general, level notes should follow the formats shown in Figures 3-19 through 3-22

below. However, local variations are acceptable--see Kavanagh 1997 for examples of different types of level notes. Level line sketches should be drawn in the field, as shown in the example at Figure 3-23 below. These sketches are particularly helpful in resolving complicated loop closures or where redundant lines have been run. Sketches may be drawn in a field book or on graph paper. They need not be at any particular orientation or scale. Original field notes or copies of notes may be submitted, as directed.

5

2/10/04

CHANGE AREA OF TIDE READINGS, WATER TO ROUGH @ SHORELINE FOR TIDE STAFF!

TIME @ 1:30 PM.

ALLW DATUM

REF. PG. 11

STA.	+ HI	-	ELV.	PAID CORR.	DESC.
B.M.	4.50	11.61	7.11		NGS DISK "KEY WEST 65L 1989"
TP.	4.62	12.54	3.69	7.92'	
B.M.			5.75	6.79' (6.79')	COE C.M. "KH4 1961"
STA.	+ HI	-	ELV.		DESC.
B.M.	6.03	12.82	6.79		COE C.M. "KH4 1961"
* TBM.	5.58	12.98	5.42	7.40	TOP OF CONC. BULKHEAD (TIDE STAFF)
TBM.	4.70	12.29	5.39	7.59	SET PKD @ "PERMANENT TIDE STAFF"
TOW			11.75	0.54	TOP OF WATER * REF SKETCH PG. 11*
TBM.	9.70	12.69	9.30	2.99	TOP OF "PERMANENT TIDE STAFF"
TP.	4.00	12.56	4.13	8.56	
B.M.			5.76	6.80' (6.79')	COE C.M. "KH4 1961"

3/24/2004 09:39 772-388-3165

Figure 3-19. Sample single-wire level notes to set tide staff (Jacksonville District--Morgan & Eklund, Inc.)

LEVELS TO BLDG. AREA - TOPD CONTROL						9-1-75 (5)	
STA.	+		UNADJ. ELEV.	ELEV.			
MON "A"	2.20			278.47	VSCE-1974		CLERK WAYN
	7.98						HALL
	0.28	10.43					HILL
	0.10	78.62					
	0.09	12.39					
	7.49	11.46					
	2.05	6.52					
	9.95	5.26					
	10.25	0.59					
	4.13	0.44					
TBM#1	36.54	-19.39	4.62	259.08	259.10	9 turns	TBM#1 is a chiseled \square in the NE bed/wall of culvert.
			55.93				
	0.93						
	1.84	11.05					
	1.27	3.28					
	2.57	10.07				4 turns	
MON "B"	6.61	-21.41	3.62	237.67	237.70	VSCE 1974	SAMPLE NOTES LEVELS
			28.02				

Figure 3-20. Sample level notes for bringing in vertical control to a project

VERTICAL CONTROL CHECKS				CONT'D	
STA	+	H.I.	-	LEVEL	ELEV.
T.P.#5	5.17	12.66			7.49 (M.L.W.)
T.P.#4	5.41	13.83	4.24		8.42
T.P.#3	4.26	12.75	5.34		8.49
T.B.M.#1	4.93	12.55	5.13		7.62
T.P.#2	4.89	12.76	4.68		7.87
T.P.#1	4.55	12.44	4.87		7.89
B.M. 1998 4580E	6.69	12.59	6.54		5.90
B.M. 1993 4580D	4.14	12.56	4.17		8.42
B.M. 1992 4580C			4.11		CALL = 8.44 8.45

9-23-04		JOB #7322	
P.P. SWANSON		C.E.C. TECHNOLOGIES, INC.	
		KEN CORNICK - P.C. & NOTES, T	
		ERIC QUIRK - R.O.	
Top Hub			
Top Hub - Same			
Same			
Same			
Same			
Same			
Same			
Same			
Same			
Same			

NOTE: PLEASE NOTE THAT LEVEL RUN IS TIDE STAFF VERTICAL DATUM IS M.L.W. (MEAN LOWER LOW WATER) EPOCH = 1980-1988 UNITS = FEET US.

Figure 3-21. Sample single-wire level notes tying in tidal benchmarks on a dredging project (Jacksonville District)

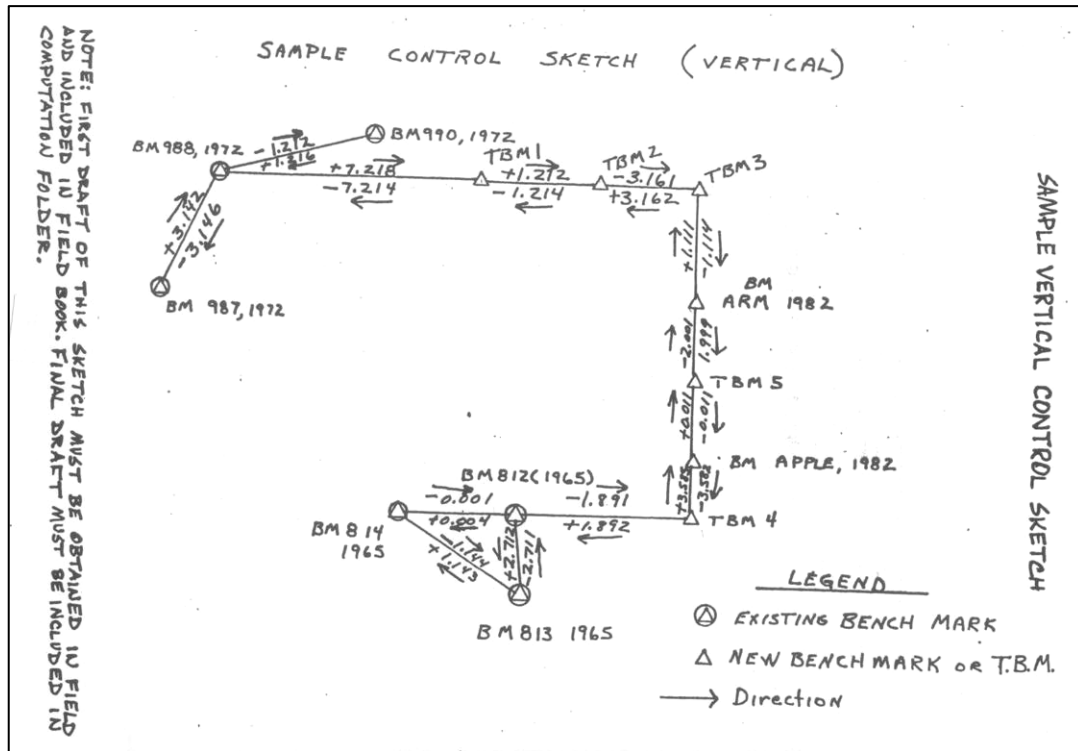

Figure 3-23. Sample vertical control project sketch showing forward and backward level runs for each leg

3-15. Calibrations and Adjustments

To maintain the required accuracy, certain tests and adjustments must be made at prescribed intervals to both the levels and rods being used.

a. Determination of stadia constant. The stadia constant factor of the leveling instrument should be determined by calibration. The stadia factor is required for measurement and computation of distances from the instrument to the leveling rod. This determination is made independently for each level used in the field and is permanently recorded and kept with project files. The determination is made by comparing the measured stadia distance to known distances on a test course.

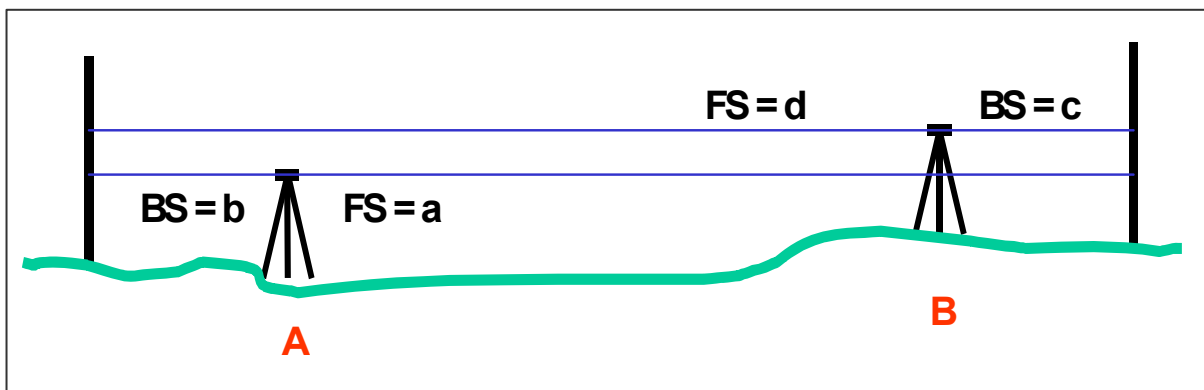

Figure 3-24. C-factor calibration procedure

b. Determination of "C" Factor. Each day, just before the leveling is begun, or just after the beginning of the day's observations, and immediately following any instance in which the level is subjected to unusual shock, the error of the level, or "C" factor, must be determined. This determination can be made during the regular course of leveling or over a special test course; in either case the recording of the observations must be done on a separate page of the recording notes with all computations shown. If the determination is made during the first setup of the regular course of levels, the following procedure is used (Figure 3-24 above). After the regular observations at the instrument station "A" are completed, transcribe the last FS reading "a" as part of the error determination; call up the backsight rodman and have the rod placed about 10 meters from the instrument; read the rod "b" over the instrument to a position "B" about 10 meters behind the front rod; read the front rod "c" and then the back rod "d". The two instrument stations must be between the rod points. The readings must be made with the level bubble carefully centered and then all three wires are read for each rod reading. The required "C" factor determined is the ratio of the required rod reading correction to the corresponding subtended interval, or:

$$C = (R1 - R2) / (R3 - R4) \tag{Eq 3-8}$$

where

- R1 = Sum near rod readings*
- R2 = Sum distant rod readings*
- R3 = Sum distant rod readings*
- R4 = Sum near rod readings*

The total correction for curvature and refraction must be applied to each distant rod reading before using them in the above formula. It must be remembered that the sum of the rod intervals must be multiplied by the stadia constant in order to obtain the actual distance before correction. The maximum permissible "C" factor varies with the stadia constant of the instrument. The instruments must be adjusted if the "C" factor is:

- C > 0.004 for a stadia constant of 1/100*
- C > 0.007 for a stadia constant of 1/200*
- C > 0.010 for a stadia constant of 1/333.*

The determination of the "C" factor should be made under the expected conditions of the survey as to length of sight, character of ground, and elevation of line of sight above the ground. The date and time must be recorded for each "C" factor determination, since this information is needed to compute leveling corrections.

Collimation Check												
Project <i>Example</i>			Location <i>Fort Belvoir, Virginia</i>			Organization <i>DMS</i>						
Observer <i>SFC Jones</i>			Recorder <i>SGT Smith</i>			Instrument <i>WILD NA2-1234</i>			Sun <i>Clear</i>	Wind <i>Calm</i>	Weather <i>Warm</i>	
From				To		Date <i>2000 09 30</i>	Time <i>0813-0835</i>	Line or Net <i>Belvoir Net 1</i>			Page No.	No. of Pgs.
Station	Backsight Face of rod	Mean	Back of rod	Interval	Sum of Intervals	Foresight Face of rod	Mean	Back of rod	Interval	Sum of Intervals	Remarks	
	1821					1055						STADIA
	1771	1771.0		050		0680	0679.7		375			CONSTANT
	1721			050	100	0304			376	751		0.100
	5313	1771.0			100	2039	0679.7			751		
	1476					2908						
	1432	1432.0		044		2530	2530.7		378			
	1388			044	088	2154			376	754		
	9609	3203.0			188	9631	3210.4			1505		
MEAN MIDDLE WIRE						C & R #1	-0.4			188		
SUM						C & R #2	-0.4		SUM (I)	1317		
ROD CORRECTIONS						SUM MEAN MIDDLE WIRE (FORESIGHT)						
CURVATURE & REFRACTION						SUM MEAN MIDDLE WIRE (BACKSIGHT)						
NOTE:						SUM (I)			1317	-6.6	C =	-0.0050
CORRECTION IS IN ROD												±
UNITS												* 754
												-3.8
												+2530.0
												2526.2
												2.526
SIGHT DISTANCE												
METERS	YARDS	C & R										
00	00	00		FOR CLASSROOM PURPOSES ONLY								
27.0	28.2	0.1										
46.8	48.9	0.2										
60.4	63.1	0.3										
71.4	74.7	0.4										
81.0	84.7	0.5										
89.5	93.6	0.6										
97.3	101.8	0.7										
104.5	109.3	0.8										
111.3	116.4	0.8										
											INST OP INT	
											1st COMP INT	
											2nd COMP INT	

DMS Form 5820-R, JAN 97

Figure 3-25. Example of C-factor computation (FM 3-34.331)

c. *Adjustment of level.* The type of instrument being used will dictate the method and procedure used to adjust the instrument if the "C" factor exceeds the allowable limits. The manufacturer's procedures should be followed when adjusting a level.

d. *Test of rod levels.* Precise rod levels must be tested once each week during regular use--or whenever they receive a severe shock. This test is made with the level rod bubble held at its center, and the deviation of the face and edge of the rod from the vertical are determined. If the deviation from the vertical exceeds 0.01 meter on a 3-meter length of rod, the rod level must be adjusted. The rod level is adjusted in the same manner as any other circular bubble. A statement must be inserted in the records showing the manner in which the test was made, the error that was found, if any, and whether an adjustment was made. When using other than precise leveling rods, this test is not required.

3-16. Care of Level Instruments

The following sections on care and maintenance of leveling equipment are taken from the CALTRANS *Surveys Manual* (CALTRANS 2002-2004). This guidance is applicable to Corps field operations.

a. *Optical Pendulum Level.* Pendulum levels are fast, accurate, and easy to maintain. Proper care and service is required to provide continuous service and to maintain precision in measurement. Never disassemble an instrument in the field. Only make those adjustments outlined in the operator's manual.

Care of a Pendulum Level:

- To prevent compensator damage, do not spin, bounce, or hit pendulum levels.
- Protect the level from dust. Dust or foreign matter inside the scope can cause the compensator damping device to hang up.

b. Circular bubble test and adjustment. Frequently check adjustment of the bullseye bubble. Adjust the bubble to the center of the bullseye. Make certain the bubble is adjusted along the line of sight and 90° to the line of sight as well. Proper adjustment reduces the possibility of compensator hang-up. Adjustment will be easier if done in the shade, where temperature is constant.

c. Horizontal cross-hair test and adjustment (Two-Peg Test). At least once every 90 days or when discrepancies show up in the leveling work and before every three-wire level survey, the “Two-Peg Test” should be performed as follows:

- Select two benchmarks “A” and “B” approximately 60 m apart.
- Set up the level midway between the two points “A” and “B” and record the rod readings of each point determining their difference in elevation.
- Move the level 6 m beyond either benchmark and record the rod reading of both points again, once again determining their difference in elevation.
- If the difference in elevation measured at each setup is the same, the level is in adjustment. If not, the horizontal cross-hair should be adjusted as detailed in the operator’s manual.
- After the adjustment repeat the “peg test” again to check the adjustment.

d. Mechanical functions. To check for compensator hang-up, lightly tap the telescope with a pencil or operate the fine movement screw jerkily to and fro. If the compensator is slow to respond or malfunctioning, send the instrument to an approved repair service. There are no mechanical field adjustments that can be made on the compensator.

e. Electronic Digital Bar-Code System. Digital bar-code levels (Figure 3-26) operate by comparing the observed digital image of a bar-code leveling rod with a map of the bar code stored in the level’s memory. These instruments are also equipped with a conventional pendulum-type compensator and may be used as an optical level. An on-board computer processes all leveling operations including determination of sight lengths. A bar-code system should include:

- Digital level with data recorder module or cable connected data collector
- Data reader and/or appropriate computer interface
- Bar-code leveling rods

(1) Field operations. At the beginning and end of each day’s operation, check the instrument for collimation error, recording the tests into the survey notes. When using electronic digital leveling instruments, the absolute collimation error will be recorded along with the leveling data. If an error in excess of 2 mm within a 60 m sight distance is detected, the level should be readjusted. If the instrument is severely jolted or bumped, or suspected as such, it should be immediately checked. Manufacturers’ specifications state that the electronic digital leveling instrument should not be exposed to direct sunlight and recommend use of an umbrella in bright sunlight.

(2) Horizontal cross-hair test and adjustment (Two-Peg Test). The test and adjustment procedure for an electronic digital level is geometrically similar to the two peg procedure for a conventional optical

level. However, all horizontal and vertical measurements and differences are measured and recorded electronically. The collimation error is recorded by the on-board computer.

(3) Data collection, storage, and transfer. Raw data generated by an electronic digital level is stored in a data collector and processed into field book format. Software will perform simple or least-squares adjustment of the data. An ASCII file may be created that can be imported into road design software.

(4) Leveling rods. Leveling rods should be maintained and checked as any other precision equipment. Accurate leveling depends as much on the condition of the rods as on the condition of the levels. Reserve an older rod for rough work, such as measuring invert, mud levels, water depths, etc.



Figure 3-26. Digital Bar Code Level--Wild NA2 (New Orleans District)

3-17. Routine Maintenance and Care of Level Rods

a. Maintenance procedures common to all types of rods are.

- Periodically lubricate hardware and slip joints with an oil-free silicon spray.
- Clean sand and grit from slip joints.
- Clean graduated faces with a damp cloth and wipe dry.
- Keep the base plate clean.
- Periodically check all screws and hardware for snugness and operation.
- Periodically check accuracy by extending rod and measuring between graduations across rod section divisions with an accurate tape.

b. Transport and storage.

- If possible, leave a wet rod uncovered and extended until it is thoroughly dry.
- Store rods in protective sleeves or cases, in a dry location, either vertically (not leaning), or horizontally. When stored horizontally, either fully support the rod or provide at least three-point support.

c. Field operations.

- Touch graduated faces only when necessary and avoid laying the rod where the graduated face will come into contact with other tools, objects, or materials that could mar the face.
- Do not abuse a rod by throwing, dropping, dragging, or placing it where it might fall.
- Do not lay a rod in sand, dust, or loose granular material.
- Lower rod sections as the rod is being collapsed. Do not let them fall or drop.

d. Direct reading rod. At frequent intervals, check all components for wear. Periodically lubricate all hardware, racks, and rollers with an oil-free silicone aerosol spray. If the tape guides begin to snag or bind the tape, have the rod repaired.

e. Fiberglass leveling rod. Dowels through the bottom of each section keep the section above from falling inside the lower section. Dropping the sections when collapsing the rod will loosen the dowels causing the sections to jam and may also shatter the fiberglass around the dowel holes. Observe the following precautions:

- When the slip joint goes bad, remove the rod from service.
- Lubricate fiberglass rods with an oil-less silicone spray or with talcum.

f. Invar leveling rods. Invar rods are precisely made and standardized; extra care is required to maintain this precision. Observe the following precautions:

- Store, fully supported and stopped, in a water-proof case.
- Do not use invar rods in rain or dust.
- Carry parallel with the ground, in alternate “face-up” and “face-down” positions to equalize weight stresses.
- Avoid laying an invar rod on the ground.
- If foreign matter has “fouled” a rod, carefully disassemble and clean.
- The rod tape must slide freely in the recessed guides as the wooden staff swells or shrinks.

g. Bar-code leveling staffs (Rods). A typical bar-code leveling staff is of a different design and construction than a conventional level rod. Several types of bar-code rods are available, depending on the type of work performed. Designs range from an aluminum/invar-tape, precise staff to various sectional staffs constructed of wood, aluminum, or fiberglass. Care and maintenance of these staffs is minimal due to their simplistic construction. Store in clean, dry condition and always transport in carrying cases.

3-18. Maintenance of Survey Instrument Accessories

a. Tripods. Tripods support and provide a fixed base for all types of surveying instruments. The typical tripod has a 5/8-in. x 11 thread fastener to secure an instrument or accessory to the tripod head. The head provides a lateral adjustment range for the instrument of approximately 25 mm. The tripods are of a wide-frame design and have extendible legs. A secure and stable tripod is required for the support of precision instruments. There should be no slack between the various components of a tripod. Loose joints or fittings will cause instability. Some guidelines to properly maintain tripods are:

- Maintain a firm snugness in all metal fittings. Over-tightening is the cause of crushed wooden components and stripped threads.
- Tighten leg hinges just enough to support the fully extended legs when a tripod is lifted clear of the ground.

- Keep the metal tripod shoes tight and free of dirt and debris.
- Keep wooden parts of tripods well painted or varnished to reduce swelling and shrinking due to moisture content of the wood.
- Always replace top caps when tripod is not in use to protect the mounting surface and head from damage.
- Use care when placing or removing tripods from the survey vehicle, as significant damage can occur. Ensure that carry compartments are designed and constructed to isolate tripods from each other and from other equipment.

b. Tribrachs. Tribrachs are the detachable base for most survey instruments and many accessories. They are equipped with an optical plummet and spherical “bullseye” level. The ability to “leapfrog” instrument setups by interchanging instruments, prisms, targets, or antennas without disturbing the setup of a tribrach greatly enhances the speed, efficiency, and accuracy of a survey. Some guidelines to properly maintain tribrachs are:

- Transport tribrachs in separate compartments or containers to prevent damage to the base surfaces, spherical level, and optical plummet.
- Do not over-tighten the tripod fastener screw.
- Clean leveling screws regularly.
- When tribrachs are not in use, set leveling screws at mid-range, usually marked by a horizontal line.
- Use care whenever using range poles mounted on a tribrach to vertically extend a sight, antenna, or prism. Extensions place considerable stress on the leveling plate.
- Adjust spherical level and vertical collimation of optical plummet routinely.

c. Prism Poles/Antenna Poles. An attached adjustable spherical level bubble (bullseye) is used to maintain a prism/antenna pole in a vertical position. A maladjusted level bubble may cause systematic error when using the pole. A simple method for checking the accuracy of the bullseye bubble is to check the rod by placing it against a door jamb or other permanent vertical part of a building that has been previously verified as being vertical.

Chapter 4

Accuracy Standards for Engineering, Construction, and Facility Management Control and Topographic Surveys

4-1. Purpose

This chapter sets forth accuracy standards and other related criteria that are recommended for use in large-scale site plan topographic surveys for engineering and construction purposes. These standards relate to surveys performed to locate, align, and stake out construction for civil and military projects, e.g., buildings, utilities, roadways, runways, flood control and navigation projects, training ranges, etc. In many cases, these engineering surveys are performed to provide the base horizontal and vertical control used for area mapping, GIS development, preliminary planning studies, detailed site plan drawings for construction plans, construction measurement and payment, preparing as-built drawings, installation master planning mapping, future maintenance and repair activities, and other AM/FM products. Most engineering surveying standards currently used are based on local practice, or may be contained in State minimum technical standards. The standards given in this chapter conform to the criteria prescribed in EM 1110-1-2909 (*Geospatial Data and Systems*) and the FGDC *Geospatial Positioning Accuracy Standard*. See Appendix A for a list of these FGDC standards.

4-2. General Surveying and Mapping Specifications

Construction plans, maps, facility plans, and CADD/GIS databases are created by a variety of terrestrial, satellite, acoustic, or aerial mapping techniques that acquire planimetric, topographic, hydrographic, or feature attribute data. Specifications for obtaining these data should be "performance-based" and not overly prescriptive or process oriented. They should be derived from the functional project requirements and use recognized industry accuracy standards where available.

a. Industry standards. Maximum use should be made of industry standards and consensus standards established by private voluntary standards bodies--in lieu of Government-developed standards. Therefore, industry-developed accuracy standards should be given preference over Government standards. A number of professional associations have published surveying and mapping accuracy standards, such as the American Society for Photogrammetry and Remote Sensing (ASPRS), the American Society of Civil Engineers (ASCE), the American Congress on Surveying and Mapping (ACSM), and the American Land Title Association (ALTA). When industry standards are non-existent, inappropriate, or do not meet a project's functional requirement, FGDC, DOD, DA, or USACE standards may be specified as criteria sources. Minimum technical standards established by state boards of registration, especially on projects requiring licensed surveyors, should be followed when legally applicable. Local surveying and mapping standards should not be developed where consensus industry standards or DOD/DA standards exist.

b. Performance specifications. Performance-oriented (i.e. outcome based) specifications are recommended in procuring surveying and mapping services. Performance specifications set forth the end results to be achieved (final map format, data content, and/or accuracy standard) and not the means, or technical procedures, used to achieve those results. Performance-oriented specifications typically provide the most flexibility and use of state-of-the-art instrumentation and techniques. Performance specifications should succinctly define only the basic mapping requirements that will be used to verify conformance with the specified criteria, e.g., mapping limits, feature location and attribute requirements, scale, contour interval, map format, sheet layout, and final data transmittal, archiving or storage requirements, required accuracy criteria standards for topographic and planimetric features that are to be depicted, and quality

assurance procedures. Performance-oriented specifications should be free from unnecessary equipment, personnel, instrumentation, procedural, or material limitations; except as needed to establish comparative cost estimates for negotiated services.

c. Prescriptive (procedural) specifications. Use of prescriptive specifications should be kept to a minimum, and called for only on highly specialized or critical projects where only one prescribed technical method is appropriate or practical to perform the work. Prescriptive specifications typically require specific field instrumentation, equipment, personnel, office technical production procedures, or rigid project phasing with on-going design or construction. Prescriptive specifications may, depending on the expertise of the writer, reduce flexibility, efficiency, and risk, and can adversely impact project costs if antiquated methods or instrumentation are required. Prescriptive specifications also tend to shift most liability to the Government. Occasionally, prescriptive specifications may be applicable to Corps projects involving specialized work not routinely performed by private surveying and mapping firms, e.g., mapping tactical operation sites, mapping hazardous, toxic, and radioactive waste (HTRW) clean-up sites, military/tactical surveying, or structural deformation monitoring of locks, dams, and other flood control structures.

d. Quality control and quality assurance. Quality control (QC) of contracted surveying and mapping work should generally be performed by the contractor. Therefore, USACE quality assurance (QA) and testing functions should be focused on whether the contractor meets the required performance specification (e.g., accuracy standard), and not the intermediate surveying, mapping, and compilation steps performed by the contractor. The contractor's internal QC will normally include independent tests that may be periodically reviewed by the Government. Government-performed (or monitored) field testing of map accuracies is an optional QA requirement, and should be performed when technically and economically justified, as determined by the ultimate project function.

e. Metrication. Surveying and mapping performed for design and construction should be recorded and plotted in the units prescribed for the project by the requesting Command or project sponsor. During transition to the metric system, inch-pound (IP) units or soft conversions may be required for some geospatial data.

f. Spatial coordinate reference systems. Where practical, feasible, or applicable, civil and military projects should be adequately referenced to nationwide or worldwide coordinate systems directly derived from, or indirectly connected to, GPS satellite observations. In addition, navigation and flood control projects in tidal areas should be vertically referenced to the latest datum epoch established by the Department of Commerce--see Appendix B (*Requirements and Procedures for Referencing Coastal Navigation Projects to Mean Lower Low Water (MLLW) Datum*) for detailed requirements and procedures.

4-3. Accuracy Standards for Engineering and Construction Surveying

a. Accuracy standards. Engineering and construction surveys are normally specified and classified based on the horizontal (linear) point closure ratio or a vertical elevation difference closure standard. This type of performance criteria is most commonly specified in Federal agency, state, and local surveying standards, and should be followed and specified by USACE commands. These standards are applicable to most types of engineering and construction survey equipment and practices (e.g., total station traverses, differential GPS, differential spirit leveling). These accuracy standards are summarized in the following tables.

**Table 4-1
Minimum Closure Accuracy Standards for Engineering and Construction Surveys**

USACE Classification	Closure Standard	
Engr & Const Control	Distance (Ratio)	Angle (Secs)
First-Order	1:100,000	$2 \cdot \sqrt{N}^1$
Second Order, Class I	1:50,000	$3 \cdot \sqrt{N}$
Second Order, Class II	1:20,000	$5 \cdot \sqrt{N}$
Third Order, Class I	1:10,000	$10 \cdot \sqrt{N}$
Third Order, Class II	1: 5,000	$20 \cdot \sqrt{N}$
Engineering Construction (Fourth-Order)	1: 2,500	$60 \cdot \sqrt{N}$

¹ N = Number of angle stations

**Table 4-2
Minimum Elevation Closure Accuracy Standards for Engineering and Construction Surveys**

USACE Classification	Elevation Closure Standard	
	(ft) ¹	(mm)
First-Order, Class I	$0.013 \cdot \sqrt{M}$	$3 \cdot \sqrt{K}$
First-Order, Class II	$0.017 \cdot \sqrt{M}$	$4 \cdot \sqrt{K}$
Second Order, Class I	$0.025 \cdot \sqrt{M}$	$6 \cdot \sqrt{K}$
Second Order, Class II	$0.035 \cdot \sqrt{M}$	$8 \cdot \sqrt{K}$
Third Order	$0.050 \cdot \sqrt{M}$	$12 \cdot \sqrt{K}$
Construction Layout	$0.100 \cdot \sqrt{M}$	$24 \cdot \sqrt{K}$

¹ \sqrt{M} or \sqrt{K} = square root of distance in Miles or Kilometers

b. Survey closure standards. Survey closure standards listed in Tables 4-1 and 4-2 should be used as a basis for classifying, standardizing, and evaluating survey work. The point and angular closures (i.e. traverse misclosures) relate to the relative accuracy derived from a particular survey. This relative accuracy (or, more correctly, precision) is estimated based on internal closure checks of a traverse survey run through the local project, map, land tract, or construction site. Relative survey accuracy estimates are always expressed as ratios of the traverse/loop closure to the total length of the survey (e.g., 1:10,000).

(1) Horizontal closure standard. The horizontal point closure ratio is determined by dividing the linear distance misclosure of the survey into the overall circuit length of a traverse, loop, or network line/circuit. When independent directions or angles are observed, as on a conventional traverse or closed loop survey, these angular misclosures should be distributed (balanced) before assessing positional misclosure. In cases where differential GPS vectors are measured in three-dimensional geocentric coordinates, then the horizontal component of position misclosure is assessed relative to Table 4-1.

(2) Vertical control standards. The vertical accuracy of a survey is determined by the elevation misclosure within a level section or level loop. For conventional differential or trigonometric leveling, section or loop misclosures (in millimeters or feet) should not exceed the limits shown in Table 4-2, where the line or circuit length is measured in the applicable units. Fourth-Order accuracies are intended for construction layout grading work.

c. Construction survey accuracy standards. Construction survey procedural and accuracy specifications should follow recognized industry and local practices. General procedural guidance is contained in a number of standard commercial texts--e.g., Kavanagh 1997. Accuracy standards for construction surveys will vary with the type of construction, and may range from a minimum of 1:2,500 up to 1:20,000. A 1:2,500 "4th-Order Construction" classification is intended to cover temporary control used for alignment, grading, and measurement of various types of construction, and some local site plan topographic mapping or photo mapping control work. Lower accuracies (1:2,500-1:5,000) are acceptable for earthwork, dredging, embankment, beach fill, and levee alignment stakeout and grading, and some site plan, curb and gutter, utility building foundation, sidewalk, and small roadway stakeout. Moderate accuracies (1:5,000) are used in most pipeline, sewer, culvert, catch basin, and manhole stakeouts, and for general residential building foundation and footing construction, and highway pavement. Somewhat higher accuracies (1:10,000-1:20,000) are used for aligning longer bridge spans, tunnels, and large commercial structures. For extensive bridge or tunnel projects, 1:50,000 or even 1:100,000 relative accuracy alignment work may be required. Grade elevations are usually observed to the nearest 0.01 ft for most construction work, although 0.1 ft accuracy is sufficient for riprap placement, earthwork grading, and small diameter pipe placement. Construction control points are usually marked by semi permanent or temporary monuments (e.g., plastic hubs, P-K nails, iron pipes, wooden grade stakes). Construction control is usually set from existing boundary, horizontal, and vertical control points.

d. Geospatial positioning accuracy standards. Many control surveys are now being efficiently and accurately performed using radial (spur) techniques--e.g., single line vectors from electronic total stations or kinematic differential GPS to monumented control points, topographic feature points, property corners, etc. Since these surveys may not always result in loop closures (i.e. closed traverse) alternative specifications for these techniques must be allowed. This is usually done by specifying a radial positional accuracy requirement. The required positional accuracy may be estimated based on the accuracy of the fixed reference point, instrument, and techniques used. Ratio closure standards in Tables 4-1 and 4-2 may slowly decline as more use is made of nation-wide augmented differential GPS positioning and electronic total station survey methods.

(1) GPS satellite positioning technology allows development of map features to varying levels of accuracy, depending on the type of equipment and procedures employed. Government and commercial augmented GPS systems allows direct, real-time positioning of static AM/FM type features and dynamic platforms (survey vessels, aircraft, etc.). Site plan drawings, photogrammetric control, and related GIS features can be directly constructed from GPS or differential GPS observations, at accuracies ranging from 1 cm to 20 meters (95%).

(2) Accuracy classifications of maps and related GIS data developed by GPS methods can be estimated based on the GPS positioning technique employed. Permanent GPS reference stations (Continuously Operating Reference Stations or CORS) can provide centimeter-level point positioning accuracies over wide ranges; thus providing direct map/feature point positioning without need for preliminary control surveys.

e. Higher-order surveys. Requirements for relative line accuracies exceeding 1:50,000 are rare for most facility engineering, construction, or mapping applications. Surveys requiring accuracies of First-Order (1:100,000) or better (e.g., A- or B-Order) should be performed using FGDC geodetic standards and specifications. These surveys must be adjusted and/or evaluated by the National Geodetic Survey (NGS) if official certification relative to the national network is required.

f. Instrumentation and field observing criteria. In accordance with the policy to use performance-based standards, rigid prescriptive requirements for survey equipment, instruments, or operating procedures are discouraged. Survey alignment, orientation, and observing criteria should rarely be rigidly specified; however, general guidance regarding limits on numbers of traverse stations, minimum traverse course lengths, auxiliary azimuth connections, etc., may be provided for information. For some highly specialized work, such as dam monitoring surveys, technical specifications may prescribe that a general type of instrument system be employed, along with any unique operating, calibration, or recordation requirements. Appendix A contains a number of technical references that may be used.

g. Connections to existing control. Surveys should normally be connected to existing local control or project control monuments/benchmarks. These existing points may be those of any Federal (including Corps project control), State, local, or private agency. Ties to local Corps or installation project control and boundary monuments are absolutely essential and critical to design, construction, and real estate. In order to minimize scale or orientation errors, at least two existing monuments should be connected. It is recommended that Corps surveys be connected with one or more stations on the National Spatial Reference System (NSRS), when practicable and feasible. Connections with local project control that have previously been connected to the NSRS are normally adequate in most cases. Connections with the NSRS shall be subordinate to the requirements for connections with local/project control. Details on these NSRS connections are given in Chapter 6.

h. Survey computations, adjustments, and quality control/assurance. Survey computations, adjustments, and quality control should be performed by the organization responsible for the actual field survey. Contract compliance assessment of a survey should be based on the prescribed point closure standards of internal loops, not on closures with external networks of unknown accuracy. In cases where internal loops are not observed, then assessment must be based on external closures. Specifications should not require closure accuracy standards in excess of those required for the project, regardless of the accuracy capabilities of the survey equipment. Least-squares adjustment methods should be optional for Second-Order or lower-order survey work. Details on network adjustments are covered in EM 1110-1-1003 (*NAVSTAR GPS Surveying*). Professional contractors should not be restricted to rigid computational methods, software, or recording forms. Use of commercial software adjustment packages is strongly recommended.

i. Data recording and archiving. Field survey data may be recorded and submitted either manually or electronically. Manual recordation should follow standard industry practice, using field book formats outlined in various technical manuals.

4-4. Accuracy Standards for Maps and Related Geospatial Products

Map accuracies are defined by the positional accuracy of a particular graphical or spatial feature depicted. A map accuracy standard classifies a map as statistically meeting a certain level of accuracy. For most engineering projects, the desired accuracy is stated in the specifications, usually based on the final development scale of the map--both the horizontal "target" scale and vertical relief (specified contour interval or digital elevation model). Often, however, in developing engineering plans, spatial databases may be developed from a variety of existing source data products, each with differing accuracies--e.g., mixing 1 inch = 60 ft topo plans with 1 inch = 400 ft reconnaissance topo mapping. Defining an

"accuracy standard" for such a mixed database is difficult and requires retention (attribution) of the source of each data feature in the base. In such cases the developer must estimate the accuracy of the mapped features.

a. ASPRS Standard. For site mapping of new engineering or planning projects, there are a number of industry and Federal mapping standards that may be referenced in contract specifications. The recommended standard for facility engineering is the ASPRS "Accuracy Standards for Large Scale Maps" (ASPRS 1989). This standard, like most other mapping standards, defines map accuracy by comparing the mapped location of selected well-defined points to their "true" location, as determined by a more accurate, independent field survey. Alternately, when no independent check is feasible or practicable, a map's accuracy may be estimated based on the accuracy of the technique used to locate mapped features--e.g., photogrammetry, GPS, total station, plane table. The ASPRS standard has application to different types of mapping, ranging from wide-area, small-scale, GIS mapping to large-scale construction site plans. It is applicable to all types of horizontal and vertical geospatial mapping derived from conventional topographic surveying or photogrammetric surveys. This standard may be specified for detailed construction site plans that are developed using conventional ground topographic surveying techniques (electronic total stations, plane tables, kinematic GPS). The ASPRS standard is especially applicable to site plan development work involving mapping scales larger than 1:20,000 (1 inch = 1,667 ft); it therefore applies to the more typical engineering map scales in the 1:240 (1 inch = 20 ft) to 1:4,800 (1 inch = 400 ft) range. Its primary advantage over other standards is that it contains more definitive statistical map testing criteria, which, from a contract administration standpoint, is desirable. Using the guidance in Tables 4-3 and 4-4 below, specifications for site plans need only indicate the ASPRS map class, target scale, and contour interval.

b. Horizontal (planimetric) accuracy criteria. The ASPRS planimetric standard compares the root mean square error (RMSE) of the average of the squared discrepancies, or differences in coordinate values between the map and an independent topographic ground survey of higher accuracy (i.e. a check survey). The "limiting RMSE" is defined in terms of meters (feet) at the ground scale rather than in millimeters (inches) at the target map scale. This results in a linear relationship between RMSE and target map scale--as map scale decreases, the RMSE increases linearly. The RMSE is the cumulative result of all errors including those introduced by the processes of ground control surveys, map compilation, and final extraction of ground dimensions from the target map. The limiting RMSE shown in Table 4-3 is the maximum permissible RMSE established by the ASPRS standard. These ASPRS limits of accuracy apply to well-defined map test points only--and only at the specified map scale.

c. Vertical (topographic) accuracy criteria. Vertical accuracy has traditionally been, and currently still is, defined relative to the required contour interval for a map. In cases where digital elevation models (DEM) or digital terrain models (DTM) are being generated, an equivalent contour interval can be specified, based on the required digital point/spot elevation accuracy. The contours themselves may be later generated from a DEM using computer software routines. The ASPRS vertical standard also uses the RMSE statistic, but only for well-defined features between contours containing interpretative elevations, or spot elevation points. The limiting RMSE for Class 1 contours is one-third of the contour interval. Testing for vertical map compliance is also performed by independent, equal, or higher accuracy ground survey methods, such as differential leveling. Table 4-4 summarizes the limiting vertical RMSE for well-defined points, as checked by independent surveys at the full (ground) scale of the map.

Table 4-3a. ASPRS Planimetric Feature Coordinate Accuracy Requirement (Ground X or Y in Meters) for Well-Defined Points

Target Map Scale		ASPRS Limiting RMSE in X or Y (Meters)		
Ratio m/m		Class 1	Class 2	Class 3
1:50		0.0125	0.025	0.038
1:100		0.025	0.05	0.075
1:200		0.050	0.10	0.15
1:500		0.125	0.25	0.375
1:1,000		0.25	0.50	0.75
1:2,000		0.50	1.00	1.5
1:2,500		0.63	1.25	1.9
1:4,000		1.0	2.0	3.0
1:5,000		1.25	2.5	3.75
1:8,000		2.0	4.0	6.0
1:10,000		2.5	5.0	7.5
1:16,000		4.0	8.0	12.0
1:20,000		5.0	10.0	15.0
1:25,000		6.25	12.5	18.75
1:50,000		12.5	25.0	37.5
1:100,000		25.0	50.0	75.0
1:250,000		62.5	125.0	187.5

Table 4-3b. ASPRS Planimetric Feature Coordinate Accuracy Requirement (Ground X or Y in Feet) for Well-Defined Points

Target Map Scale		ASPRS Limiting RMSE in X or Y (Feet)		
1"= x ft	Ratio ft/ft	Class 1	Class 2	Class 3
5	1:60	0.05	0.10	0.15
10	1:120	0.10	0.20	0.30
20	1:240	0.2	0.4	0.6
30	1:360	0.3	0.6	0.9
40	1:480	0.4	0.8	1.2
50	1:600	0.5	1.0	1.5
60	1:720	0.6	1.2	1.8
100	1:1,200	1.0	2.0	3.0
200	1:2,400	2.0	4.0	6.0
400	1:4,800	4.0	8.0	12.0
500	1:6,000	5.0	10.0	15.0
800	1:9,600	8.0	16.0	24.0
1,000	1:12,000	10.0	20.0	30.0
1,667	1:20,000	16.7	33.3	50.0

Table 4-4a. ASPRS Topographic Elevation Accuracy Requirement for Well-Defined Points (Meters)

ASPRS Limiting RMSE in Meters							
Target Contour Interval	Topographic Feature Points			Spot or Digital Terrain Model Elevation Points			
Meters	Class 1	Class 2	Class 3	Class 1	Class 2	Class 3	
0.10	0.03	0.07	0.10	0.02	0.03	0.05	
0.20	0.07	0.13	0.2	0.03	0.07	0.10	
0.25	0.08	0.17	0.25	0.04	0.08	0.12	
0.5	0.17	0.33	0.50	0.08	0.16	0.25	
1	0.33	0.66	1.0	0.17	0.33	0.5	
2	0.67	1.33	2.0	0.33	0.67	1.0	
4	1.33	2.67	4.0	0.67	1.33	2.0	
5	1.67	3.33	5.0	0.83	1.67	2.5	
10	3.33	6.67	10.0	1.67	3.33	5.0	

Table 4-4b. ASPRS Topographic Elevation Accuracy Requirement for Well-Defined Points (Feet)

ASPRS Limiting RMSE in Feet							
Target Contour Interval	Topographic Feature Points			Spot or Digital Terrain Model Elevation Points			
ft	Class 1	Class 2	Class 3	Class 1	Class 2	Class 3	
0.5	0.17	0.33	0.50	0.08	0.16	0.2	
1	0.33	0.66	1.0	0.17	0.33	0.5	
2	0.67	1.33	2.0	0.33	0.67	1.0	
4	1.33	2.67	4.0	0.67	1.33	2.0	
5	1.67	3.33	5.0	0.83	1.67	2.5	

d. Map accuracy quality assurance testing and certification. Independent map testing is a quality assurance function that is performed independent of normal quality control during the mapping process. Specifications and/or contract provisions should indicate the requirement (or option) to perform independent map testing. Independent map testing is rarely performed for engineering and construction surveys. If performed, map testing should be completed within a fixed time period after delivery, and if performed by contract, after proper notification to the contractor. In accordance with the ASPRS standard, the horizontal and vertical accuracy of a map is checked by comparing measured coordinates or elevations from the map (at its intended target scale) with spatial values determined by a check survey of higher accuracy. The check survey should be at least twice (preferably three times) as accurate as the map feature tolerance given in the ASPRS tables, and a minimum of 20 points tested. Maps and related geospatial databases found to comply with a particular ASPRS standard should have a statement indicating that standard. The compliance statement should refer to the data of lowest accuracy depicted

on the map, or, in some instances, to specific data layers or levels. The statement should clearly indicate the target map scale at which the map or feature layer was developed. When independent testing is not performed, the compliance statement should clearly indicate that the procedural mapping specifications were designed and performed to meet a certain ASPRS map classification, but that a rigid compliance test was not performed. Published maps and geospatial databases whose errors exceed those given in a standard should indicate in their legends or metadata files that the map is not controlled and that dimensions are not to scale. This accuracy statement requirement is especially applicable to GIS databases that may be compiled from a variety of sources containing known or unknown accuracy reliability.

e. National Standard for Spatial Data Accuracy (NSSDA). The traditional small-scale "United States National Map Accuracy Standard" (Bureau of the Budget 1947) has been revised by the FGDC as the NSSDA ("Geospatial Positioning Accuracy Standards, PART 3: National Standard for Spatial Data Accuracy"). This latest version of the NSSDA indicates it is directly based on the ASPRS standard; however, the ASPRS coordinate-based standard is converted to a 95% radial error statistic and the vertical standard is likewise converted from a one-sigma (68%) to 95% standard. The NSSDA defines positional accuracy of spatial data, in both digital and graphic form, as derived from sources such as aerial photographs, satellite imagery, or other maps. Its purpose is to facilitate the identification and application of spatial data by implementing a well-defined statistic (i.e. the 95% confidence level) and testing methodology. As in the ASPRS standard, accuracy is assessed by comparing the positions of well-defined data points with positions determined by higher accuracy methods, such as ground surveys. Unlike the above ASPRS tables, the draft NSSDA standard does not define pass-fail criteria--data and map producers must determine what accuracy exists for their data. Users of that data determine what constitutes acceptable accuracies for their applications. Unlike the ASPRS standard that uses the RMSE statistic in the X, Y, and Z planes, the NSSDA defines horizontal spatial accuracy by circular error of a data set's horizontal (X & Y) coordinates at the 95% confidence level. Vertical spatial data is defined by linear error of a data set's vertical (Z) coordinates at the 95% confidence level. ASPRS lineal horizontal accuracies in X and Y can be converted to NSSDA radial accuracy by multiplying the limiting RMSE values by 2.447, that is:

$$\text{Radial Accuracy}_{NSSDA} = 2.447 \cdot \text{RMSE}_{ASPRS-X \text{ or } Y} \quad (\text{Eq 4-1})$$

ASPRS 1-sigma (68%) vertical accuracies can be converted to NSSDA 95% lineal accuracy by multiplying the limiting RMSE values by 1.96, or:

$$\text{Vertical Accuracy}_{NSSDA} = 1.96 \cdot \text{RMSE}_{ASPRS-Z} \quad (\text{Eq 4-2})$$

In time, it is expected that the NSSDA will be the recognized standard for specifying the accuracy of all mapping and spatial data products, and the ASPRS standard will be modified to 95% confidence level specifications.

f. Other mapping standards. When work is performed for DOD tactical elements or other Federal agencies or overseas, mapping standards other than ASPRS may be required.

4-5. Photogrammetric Mapping Standards and Specifications

Most smaller scale (e.g., less than 1 inch = 100 ft or 1:1,200) engineering topographic mapping and GIS data base development is accomplished by aerial mapping techniques. The ASPRS standards should be used in specifying photogrammetric mapping accuracy requirements. Procedures for developing photogrammetric mapping specifications are contained in EM 1110-1-1000 (*Photogrammetric Mapping*). This manual contains guidance on specifying flight altitudes, determining target scales, and photogrammetric mapping cost estimating techniques. A full contract guide specification is also contained in an appendix to EM 1110-1-1000.

4-6. Cadastral or Real Property Survey Accuracy Standards

a. General. Many State codes, rules, statutes, or general professional practices prescribe minimum technical standards for real property surveys. Corps in-house surveyors or contractors should follow applicable State technical standards for real property surveys involving the determination of the perimeters of a parcel or tract of land by establishing or reestablishing corners, monuments, and boundary lines, for the purpose of describing, locating fixed improvements, or platting or dividing parcels. Although some State standards relate primarily to accuracies of land and boundary surveys, other types of survey work may also be covered in some areas. Refer to ER 405-1-12, (*Real Estate Handbook*), and the "*Manual of Instructions for the Survey of the Public Lands of the United States*" (US Bureau of Land Management 1973) for additional technical guidance on performing cadastral surveys, or surveys of private lands abutting or adjoining Government lands.

b. ALTA/ACSM standards. Real property survey accuracy standards recommended by ALTA/ACSM are contained in "*Minimum Standard Detail Requirements for ALTA/ACSM Land Title Surveys*" (ALTA 1999), a portion of which is excerpted below. (Note that these ALTA standards are periodically updated--the latest version should be obtained from the reference noted in Appendix A-3). This standard was developed to provide a consistent national standard for land title surveys and may be used as a guide in specifying accuracy closure requirements for USACE real property surveys. However, it should be noted that the ALTA/ACSM standard itself not only prescribes closure accuracies for land use classifications but also addresses specific needs particular to land title insurance matters. The standards contain requirements for detailed information and certification pertaining to land title insurance, including information discoverable from the survey and inspection that may not be evidenced by the public records. The standard also contains a table as to optional survey responsibilities and specifications that the title insurer may require. USACE cadastral surveys not involving title insurance should follow State minimum standards, not ALTA/ACSM standards. On land acquisition surveys which may require title insurance, the decision to perform an ALTA/ACSM standard survey, including all optional survey responsibilities and specifications, should come from the project sponsor. Meeting ALTA/ACSM Urban Class accuracy standards is considered impractical for small tracts or parcels less than 1 acre in size.

Accuracy Standards for ALTA-ACSM Land Title Surveys

Introduction

These Accuracy Standards address Positional Uncertainty and Minimum Angle, Distance and Closure Requirements for ALTA-ACSM Land Title Surveys. In order to meet these standards, the Surveyor must assure that the Positional Uncertainties resulting from the survey measurements made on the survey do not exceed the allowable Positional Tolerance. If the size or configuration of the property to be surveyed or the relief, vegetation, or improvements on the property will result in survey measurements for which the Positional Uncertainty will exceed the allowable Positional Tolerance, the surveyor must alternatively apply the within table of "Minimum Angle, Distance and Closure Requirements for Survey Measurements Which Control Land Boundaries for ALTA-ACSM Land Title Surveys" to the measurements made on the survey or employ, in his or her judgment, proper field procedures, instrumentation and adequate survey personnel in order to achieve comparable results.

The lines and corners on any property survey have uncertainty in location which is the result of (1) availability and condition of reference monuments, (2) occupation or possession lines as they may differ from record lines, (3) clarity or ambiguity of the record descriptions or plats of the surveyed tracts and its adjoiners and (4) Positional Uncertainty.

The first three sources of uncertainty must be weighed as evidence in the determination of where, in the professional surveyor's opinion, the boundary lines and corners should be placed. Positional Uncertainty is related to how accurately the surveyor is able to monument or report those positions.

Of these four sources of uncertainty, only Positional Uncertainty is controllable, although due to the inherent error in any measurement, it cannot be eliminated. The first three can be estimated based on evidence; Positional Uncertainty can be estimated using statistical means.

The surveyor should, to the extent necessary to achieve the standards contained herein, compensate or correct for systematic errors, including those associated with instrument calibration. The surveyor shall use appropriate error propagation and other measurement design theory to select the proper instruments, field procedures, geometric layouts and computational procedures to control and adjust random errors in order to achieve the allowable Positional Tolerance or required traverse closure.

If radial survey methods are used to locate or establish points on the survey, the surveyor shall apply appropriate procedures in order to assure that the allowable Positional Tolerance of such points is not exceeded.

Definitions:

"Positional Uncertainty" is the uncertainty in location, due to random errors in measurement, of any physical point on a property survey, based on the 95% confidence level.

"Positional Tolerance" is the maximum acceptable amount of Positional Uncertainty for any physical point on a property survey relative to any other physical point on the survey, including lead-in courses.

Computation of Positional Uncertainty

The Positional Uncertainty of any physical point on a survey, whether the location of that point was established using GPS or conventional surveying methods, may be computed using a minimally constrained, correctly weighted least squares adjustment of the points on the survey.

Positional Tolerances for Classes of Survey

0.07 feet (or 20mm) + 50ppm

Application of Minimum Angle, Distance, and Closure Requirements

The combined precision of a survey can be statistically assured by dictating a combination of survey closure and specified procedures for an ALTA/ACSM Land Title Survey. ACSM, NSPS and ALTA have adopted the following specific procedures in order to assure the combined precision of an ALTA/ACSM Land Title Survey. The statistical base for these specifications is on file at ACSM and available for inspection.

American Congress On Surveying and Mapping
Minimum Angle, Distance and Closure Requirements for Survey Measurements
Which Control Land Boundaries for ALTA/ACSM Land Title Surveys
(Note 1)

Dir. Reading of Instrument (Note 2)	Instrument Reading Estimated (Note 3)	Number of Observations Per Station (Note 4)	Spread From Mean of D&R Not To Exceed (Note 5)	Angle Closure Where N=No. of Stations Not To Exceed	Linear Closure (Note 6)	Distance Measurement (Note 7)	Minimum Length of Measurements (Notes 8, 9, 10)
20" <1'> 10"	5" <0.1'> N.A.	2 D&R	5" <0.1'> 5"	10" \sqrt{N}	1:15,000	EDM or Double tape with Steel Tape	(8) 81m, (9) 153m, (10) 20m

Note (1) All requirements of each class must be satisfied in order to qualify for that particular class of survey. The use of a more precise instrument does not change the other requirements, such as number of angles turned, etc.

Note (2) Instrument must have a direct reading of at least the amount specified (not an estimated reading), i.e.: 20" = Micrometer reading theodolite, <1'> = Scale reading theodolite, 10" = Electronic reading theodolite.

Note (3) Instrument must have the capability of allowing an estimated reading below the direct reading to the specified reading.

Note (4) D & R means the Direct and Reverse positions of the instrument telescope, i.e., Urban Surveys require that two angles in the direct and two angles in the reverse position to be measured and meaned.

Note (5) Any angle measured that exceeds the specified amount from the mean must be rejected and the set of angles re-measured.

Note (6) Ratio of closure after angles are balanced and closure calculated.

Note (7) All distance measurements must be made with a properly calibrated EDM or Steel tape, applying atmospheric, temperature, sag, tension, slope, scale factor and sea level corrections as necessary.

Note (8) EDM having an error of 5 mm, independent of distance measured (Manufacturer's specifications).

Note (9) EDM having an error of 10 mm, independent of distance measured (Manufacturer's specifications).

Note (10) Calibrated steel tape.

4-7. Hydrographic Surveying Accuracy Standards

Hydrographic surveys are performed for a variety of engineering, construction, and dredging applications in USACE. Accuracy standards, procedural specifications, and related technical guidance are contained in EM 1110-2-1003 (*Hydrographic Surveying*). This manual should be attached to any A-E contract containing hydrographic surveying work, and must be referenced in construction dredging contracts involving in-place measurement and payment. Standards in this manual apply to Corps river and harbor navigation project surveys, such as dredge measurement and payment surveys, channel condition surveys of inland and coastal Federal navigation projects, beach renourishment surveys, and surveys of other types of marine structures. Accuracy standards are given for different project conditions and depths. Standards for nautical charting surveys or deep-water bathymetric charting surveys should conform to applicable DOD, National Ocean Survey (NOS), or US Naval Oceanographic Office (USNAVOCEANO) accuracy and chart symbolization criteria.

4-8. Structural Deformation Survey Standards

Deformation monitoring surveys of Corps structures require high line vector and/or positional accuracies to monitor the relative movement of monoliths, walls, embankments, etc. Deformation monitoring survey accuracy standards vary with the type of construction, structural stability, failure probability and impact, etc. Since many periodic surveys are intended to measure "long-term" (e.g., monthly or yearly changes) deformations relative to a stable network, lesser survey precisions are required than those needed for short-term structural deflection type measurements. Long-term structural movements measured from points external to the structure may be tabulated or plotted in either X-Y-Z or by single vector movement normal to a potential failure plane. Accuracy standards and procedures for structural deformation surveys are contained in EM 1110-2-1009 (*Structural Deformation Surveying*). Horizontal and vertical deformation monitoring survey procedures are performed relative to a control network established for the structure. Ties to the National Spatial Reference System are not necessary other than for general reference, and then need only USACE Third-Order connection.

4-9. Geodetic Control Survey Standards

Geodetic control surveys are usually performed for the purpose of establishing a basic framework of the National Spatial Reference System (NSRS). These geodetic network densification survey functions are clearly distinct from the traditional engineering and construction surveying and mapping standards covered in this chapter. Geodetic control surveys of permanently monumented control points that are incorporated in the NSRS must be performed to far more rigorous standards and specifications than are control surveys used for general engineering, construction, mapping, or cadastral purposes. When a project requires NSRS densification, or such densification is a desirable by-product and is economically justified, USACE Commands should conform to published FGDC survey standards and specifications. This includes related automated data recording, submittal, project review, and adjustment requirements mandated by FGDC and the National Geodetic Survey. Geodetic survey accuracy and procedural specifications published by the FGDC or NGS include:

- "Standards and Specifications for Geodetic Control Networks" (FGCS 1984)
- "Input Formats and Specifications of the National Geodetic Survey Data Base," NOAA, National Geodetic Survey, (NOAA 1994)

- "Geometric Geodetic Accuracy Standards and Specifications for Using GPS Relative Positioning Techniques (Preliminary)" (FGCS 1988)
- "Guidelines for Submitting GPS Relative Positioning Data to the National Geodetic Survey" (NGS 1988)
- "Geospatial Positioning Accuracy Standards--Part 2: Standards for Geodetic Networks" (FGDC 1998b)
- "Guidelines for Establishing GPS-Derived Ellipsoid Heights (Standards: 2 cm and 5 cm)" (NOAA 1997)

Copies of these specifications and standards can be downloaded from the NGS website--see Appendix A. These FGCS/NGS standards and specifications should rarely be specified for Corps control surveys in that they prescribe far more demanding criteria than that needed to establish control for most engineering projects. These FGDC/NGS standards can also easily add 50% or more time and cost to a control survey project.

Part 2 of the FGDC *Geospatial Positioning Accuracy Standards* (Standards for Geodetic Networks)--FGDC 1988b-- prescribes a positional accuracy criteria instead of the traditional linear closure (misclosure) criteria. It is expected that this positional accuracy standard will gradually replace the misclosure standards in Tables 4-1 and 4-2. This new standard is excerpted in Table 4-5 below.

**Table 4-5. FGDC Part 2 Accuracy Standards for Geodetic Networks
Horizontal, Ellipsoid Height, and Orthometric Height**

Accuracy Classification	95-Percent Confidence Less Than or Equal to:
1-Millimeter	0.001 meters
2-Millimeter	0.002 "
5-Millimeter	0.005 "
1-Centimeter	0.010 "
2-Centimeter	0.020 "
5-Centimeter	0.050 "
1-Decimeter	0.100 "
2-Decimeter	0.200 "
5-Decimeter	0.500 "
1-Meter	1.000 "
2-Meter	2.000 "
5-Meter	5.000 "
10-Meter	10.000 "

NOTE: The classification standard for geodetic networks is based on accuracy. Accuracies are categorized separately according to horizontal, ellipsoid height, and orthometric height. Note: although the largest entry in the table is 10 meters, the accuracy standards can be expanded to larger numbers if needed.

4-10. State and Local Accuracy Standards

Most State and local governments prescribe survey and map accuracy standards. These are usually similar to those standards given in the previous tables in this chapter. State surveyor licensing boards may prescribe “minimum technical standards” for various real property surveys. State transportation departments may have additional standards unique to their design and construction requirements.

a. General state surveying and mapping standards. Below is an excerpt of surveying accuracy standards taken from the Florida Administrative Code (FAC 2003). These standards for general boundary surveys are representative of minimum technical standards used by many states.

(1) Survey and Map Accuracy

(a) *REGULATIONAL OBJECTIVE: The public must be able to rely on the accuracy of measurements and maps produced by a surveyor and mapper. In meeting this objective, surveyors and mappers must achieve the following minimum standards of accuracy, completeness, and quality.*

(b) *The accuracy of the survey measurements shall be premised upon the type of survey and the expected use of the survey and map. All measurements must be in accordance with the United States standard, using either feet or meters. Records of these measurements shall be maintained for each survey by either the individual surveyor and mapper or the surveying and mapping business entity. Measurement and computation records must be dated and must contain sufficient data to substantiate the survey map and insure that the accuracy portion of these standards has been met.*

(c) *Vertical Control: Field-measured control for elevation information shown upon survey maps shall be based on a level loop. Closure in feet must be accurate to a standard of plus or minus .05 ft. times the square root of the distance in miles. All surveys and maps with elevation data shall indicate the datum and a description of the benchmark(s) upon which the survey is based. Minor elevation data may be obtained on an assumed datum provided the base elevation of the datum is obviously different than the established datum.*

(d) *Vertical Feature Accuracy:*

1. *If contour lines are shown, then sufficient data must be obtained in order to insure that 90% of ground point elevations taken from contours are within 1/2 of the contour interval, and the remainder are not in error more than the contour interval.*

2. *For surveys performed by photogrammetric methods, vertical positional accuracy of map elevations, contours, or other forms of terrain models must be stated. The stated accuracy is a plus or minus tolerance that encompasses 90% of elevation differences between survey measured values and ground truth. All such survey maps or reports with elevation data shall have a statement to the effect: “Elevations of well-identified features contained in this survey been measured to an estimated vertical positional accuracy of: ____ (ft) (m).” If different accuracy levels exist for different features, then applicable features and accuracies shall be identified with similar statements.*

(e) *Horizontal Control: All surveys and maps expressing or displaying features in coordinate position shall indicate the coordinate datum and a description of the control points upon which the survey is based. Minor coordinate data may be obtained on an assumed datum provided the numerical basis of the datum is obviously different than an established datum. The accuracy of field-measured control measurements shall be statistically verified by measurement and calculation of a closed geometric figure. All control measurements shall be made with a transit and steel tape, or devices with equivalent or higher degrees of accuracy. The relative distance accuracy must be better than the following:*

- *Commercial/High Risk Linear: 1 foot in 10,000 feet;*
- *Suburban: Linear: 1 foot in 7,500 feet;*
- *Rural: Linear: 1 foot in 5,000 feet;*

(f) *Horizontal Feature Accuracy (for surveys by photogrammetric methods only): A survey and map's horizontal positional accuracy must be stated. The stated accuracy is a plus or minus tolerance that encompasses 90% of coordinate differences between survey measured values and ground truth. All survey maps or reports shall have a statement of the effect: "Well-identified features in this survey and map have been measured to an estimated horizontal positional accuracy of * [] (ft) (m)." If different accuracy levels exist for different features, then applicable features and accuracies shall be identified with similar statements.*

(g) *Map Plotting Accuracy: The horizontal position of physical features surveyed by field methods must be plotted to within 1/20 of an inch at the map scale.*

(h) *Intended Display Scale: At the maximum intended display scale, a survey and map's positional accuracy value occupies 1/20" on the display. All maps or reports of surveys produced by photogrammetric methods and delivered with digital coordinate files must contain a statement to the effect of: "This map is intended to be displayed at a scale of 1/ * [] or smaller."*

(2) *Other Provisions that Apply to All Surveys and Maps.*

(a) *REGULATIONAL OBJECTIVE: In order to avoid misuse of a survey and map, the surveyor and mapper must adequately communicate the survey results to the public through a map, report, or report with an attached map. Any survey map or report must identify the responsible surveyor and mapper and contain standard content. In meeting this objective, surveyors and mappers must meet the following minimum standards of accuracy, completeness, and quality:*

(b) *Each survey map and report shall state the type of survey it depicts consistent with the types of surveys defined in Rule 61G17-6.002(8)(a)-(k), F.A.C. The purpose of a survey, as set out in Rule 61G17-6.002(8)(a)-(l), F.A.C., dictates the type of survey to be performed and depicted, and a licensee may not avoid the minimum standards required by rule of a particular survey type merely by changing the name of the survey type to conform with what standards or lack of them the licensee chooses to follow.*

(c) *All survey maps and reports must bear the name, certificate of authorization number, and street and mailing address of the business entity issuing the map and report, along with the name and license number of the surveyor and mapper in responsible charge. The name, license number, and street and mailing address of a surveyor and mapper practicing independent of any business entity must be shown on each survey map and report.*

(d) *All survey maps must reflect a survey date, which is the date of the field survey or the date of image acquisition for photogrammetric surveys. If the graphics of a map are revised, but the survey date stays the same, the map must list dates for all revisions.*

(l) *Responsibility Clearly Stated. The responsibility for all mapped features must be clearly depicted on any map or report signed by a Florida licensed surveyor and mapper. In the case that features surveyed by the signing surveyor and mapper have been integrated with features surveyed by others, then the full extent of responsibility shall be clearly depicted on the map or report, and the signing surveyor and mapper shall include in the map or report an assessment of the quality and accuracy of all mapped features delivered.*

b. *DOT control survey standards.* The following Third-Order survey standards shown in Figures 4-1 and 4-2 below are from the CALTRANS *Surveys Manual*. The first standard is for establishing permanent Third-Order horizontal control using a total station. The second is a Third-Order standard for differential leveling--covering different types of levels. Figure 4-3 depicts a CALTRANS accuracy standard for setting primary control around a project site. The classifications and closure standards are identical with those in Tables 4-1 and 4-2. The "G" classification is roughly comparable to USACE "4th Order" classification

Specifications	Traverse/Network Resection Double Tie
Check vertical index error	Daily
Check horizontal collimation	Daily
Measure instrument height and target height	Begin and end of each setup
Use plummet to check position of target and instrument over points	Begin and end of each setup
Measure temperature and pressure and enter ppm correction into total station	First set-up of day
Measure distance to backsight and foresight at each setup	Required
Observe traverse multiple ties to improve least squares adjustment	As Feasible
Close all traverses	Required
Horizontal angle observations, minimum	3D, 3R
Vertical angle observations, minimum	3D, 3R
Angular rejection limit, residual not to exceed	5"
Maximum value for the standard error of the mean	1.2"
Minimum distance measurement to meet horizontal accuracy standard	50 m
Minimum number of distance measurements	3
Distance rejection limit: residual not to exceed	2mm + 2 ppm
Maximum distance measurement to meet vertical accuracy standard	100 m

Figure 4-1. CALTRANS Third-Order horizontal control standards (Total Station)

Operation/Specification	Compensator-Level Three-Wire Observation	Compensator-Level Single-Wire Observation	Electronic/Digital Bar Code Level
Difference in length between fore and back sights, not to exceed per setup	10 m	10 m	10 m
Cumulative difference in length between fore and backsights, not to exceed per loop or section	10 m	10 m	10 m
Maximum sight lengths	90 m	90 m	90 m <i>(See Note 1)</i>
Minimum ground clearance of sight line	0.5 m	0.5 m	0.5 m
Maximum section misclosure	$12 \text{ mm} \times \sqrt{D}$ <i>(See Note 2)</i>	$12 \text{ mm} \times \sqrt{D}$ <i>(See Note 2)</i>	$8 \text{ mm} \times \sqrt{D}$ <i>(See Note 2)</i>
Maximum loop misclosure	$12 \text{ mm} \times \sqrt{E}$ <i>(See Note 3)</i>	$12 \text{ mm} \times \sqrt{E}$ <i>(See Note 3)</i>	$8 \text{ mm} \times \sqrt{E}$ <i>(See Note 3)</i>
Difference between top and bottom interval not to exceed	0.30 of rod unit	N/A	N/A
Collimation (Two-Peg) Test	Daily <i>(See Note 4)</i> (not to exceed 2 mm)	Daily	Daily
Minimum number of readings (Use repeat measure option for each observation)	N/A	N/A	3 <i>(See Note 5)</i>

Figure 4-2. CALTRANS Third-Order differential leveling standards

CALTRANS ORDER (Note 1)	STANDARDS			MONUMENT SPACING AND SURVEY METHODS (Note 2)		APPLICATION – TYPICAL SURVEYS	
	CLASSICAL		MONUMENT SPACING (MINIMUM)	TYPICAL SURVEY METHOD		HORIZONTAL	VERTICAL
	HORIZONTAL (Note 4)	VERTICAL (Note 5)		HORIZONTAL	VERTICAL		
B (Note 3)	1:1,000,000	Not Applicable	10 k	GPS: Static	Not Applicable	High Precision Geodetic Network (HPGN)	Not Applicable
First (Note 3)	1:100,000 (Note 10)	e = 5√E	3 k	GPS: Static Fast Static	Bar Code	Basic (Corridor) Control – HPGN-D Project Control – Horizontal (preferred, when feasible)	Rarely used. Crustal Motion Surveys, etc.
Second	1:20,000	e = 8√E	500 m	GPS: Static Fast Static Net Traverse	Bar Code 3-Wire TSSS: Trig	Project Control – Horizontal (see First Order also)	Basic (Corridor) Control HPGN and HPGN-D Project Control
Third	1:10,000	e = 12√E	As Required	GPS: Static Fast Static Kinematic RTK (Note 13) Net Traverse Resection Double Tie (Note 9)	Bar Code Single Wire TSSS: Trig GPS: Static (Note 7) RTK (Note 11)	Supplemental Control > Engineering > Construction • Interchange • Major Structure Photo. Control – Horizontal Right of Way Surveys Construction Surveys (Note 6) Topographic Surveys (Note 6) Major Structure Points (Staked)	Project Control – Vertical Supplemental Control Photo. Control – Vertical Construction Surveys (Note 6) Topographic Surveys (Note 6) Major Structure Points (Staked)
G (General)	As required, see appropriate survey procedure section in this manual for accuracy standards/tolerances.		Not Applicable	GPS: Fast Static Kinematic RTK TSSS: Radial	GPS: Fast Static Kinematic, RTK (Note 12) TSSS: Trig Single Wire Direct Elevation Rod	Topographic Surveys (Data Points) Supplement Design Data Surveys Construction Surveys (Staked Points) Environmental Surveys GIS Data Surveys Right of Way Flagging	

Notes

- The standards, specifications, and procedures included in this Manual are based on Federal Geodetic Control Subcommittee (FGCS) standards and specifications. Except where otherwise noted, the FGCS requirements have been modified to meet Caltrans needs.
- Refer to other Manual sections for detailed procedural specifications for specific survey methods and types of surveys.
- "B" Order and First Order surveys are performed to FGCS standards and specifications or other requirements approved by National Geodetic Survey.
- Distance accuracy standard.
- Closure between established control: e = maximum misclosure in mm, E = distance in km.
- Survey setup points used for radial stake out.
- For example a static GPS may be used to establish NAD83 at the project site from a distant NAD National Spatial Reference System Control.
- As required by the local survey needs.
- Instead of including a point as a network point, certain survey points may be positioned by observations from two or more control points (i.e., double tied). If survey points are not included in a network, double ties must be performed to ensure that blunders are eliminated and the positions established are within stated accuracy standard. Double tie procedures should be only used when appropriate; possible examples are photo control points, land net and monumentation points, and major structure stake points.
- The distance accuracy standard for Basic (Corridor) Control – HPGN-D surveys is 1:500,000.
- Not to include vertical project control or vertical for major structure points.
- Not to include pavement elevations.
- Not to include major structures.

Figure 4-3. CALTRANS accuracy classifications and standards

4-11. CADD/GIS Technology Center Standards

The CADD/GIS Technology Center [for Facilities, Infrastructure, and Environment] is located at the USACE Waterways Experiment Station in Vicksburg, MS. The Center's primary mission is to serve as a multi-service vehicle to set computer-aided design and drafting (CADD) and geographic information system (GIS) standards; coordinate CADD/GIS facilities systems within the Department of Defense (DOD); promote CADD/GIS system integration; support centralized CADD/GIS hardware and software acquisition; and provide assistance for the installation, training, operation, and maintenance of CADD and GIS systems. The intent of the CADD/GIS Technology Center standards development initiatives has been to develop usable CADD, GIS, and facility management (FM) standards that will satisfy the project life-cycle concept for digital data. This concept requires a set of CADD, GIS, and FM standards for initial data collection, analysis, design, construction, and subsequent master planning, facility management, and maintenance. This allows for direct integration from CADD engineering design or as-builts to such GIS analysis tasks as master planning and FM. The Center has issued a number of geospatial standards and related CADD/GIS guidance. Some of these standards include:

- Spatial Data Standard for Facilities, Infrastructure, and Environment (SDSFIE)
- Facility Management Standard for Facilities, Infrastructure, and Environment (FMSFIE)
- A/E/C CADD Standard

These A/E/C CADD standards define symbology, level/layer assignments, drafting templates, sheet layouts, and other criteria required in a CADD environment. The SDSFIE Standards define the attributes and attribute values for geospatial data features. These standards should be specified for in-house or A-E services requiring delivery of CADD, GIS, and other spatial and geospatial data covered by this chapter.

4-12. Mandatory Standards

The accuracy standards in the following tables in this chapter are considered mandatory.

- Table 4-1: Minimum Closure Accuracy Standards for Engineering and Construction Surveys
- Table 4-2: Minimum Elevation Closure Accuracy Standards for Engineering and Construction Surveys
- Table 4-3a: ASPRS Planimetric Feature Coordinate Accuracy Requirement (Ground X or Y in Meters) for Well-Defined Points
- Table 4-3b: ASPRS Planimetric Feature Coordinate Accuracy Requirement (Ground X or Y in Feet) for Well-Defined Points
- Table 4-4a: ASPRS Topographic Elevation Accuracy Requirement for Well-Defined Points (Meters)
- Table 4-4b: ASPRS Topographic Elevation Accuracy Requirement for Well-Defined Points (Feet)

HQUSACE has directed that geospatial data collected for architectural, engineering, and construction projects shall be compliant with the A/E/C CADD Standard and/or the SDSFIE Standard. This includes data that is collected, developed, or contracted for, and/or otherwise executed by the Corps of Engineers. Topographic survey data falls within this directive.

Chapter 5 Geodetic Reference Datums and Local Coordinate Systems

5-1. Purpose and Background

This chapter provides guidance on geodetic reference datums, coordinate systems, and local horizontal and vertical reference systems that are used to georeference Corps military construction and civil works projects. Use of State Plane Coordinate Systems (SPCS) is covered in detail since these systems are most commonly used to reference topographic surveys of local projects. Transformations between datums and coordinate systems are discussed. Site calibration techniques needed for RTK topographic surveys are covered in Chapter 9.

a. Topographic surveys can be performed on any coordinate system. Most localized total station topographic surveys are initiated on (or referenced to) an arbitrary coordinate grid system, e.g., X=5,000 ft, Y=5,000 ft, Z=100 ft, and often elevation or scale reductions are ignored. Planimetric and topographic data points collected on this arbitrary grid in a data collector are then later translated, rotated, scaled, and/or "best fit" to some established geographical reference system--e.g., the local State Plane Coordinate System (SPCS).

b. The process of converting the observed topographic points on the arbitrary grid system to an established geographical reference system (e.g., SPCS) is termed a "datum transformation." In order to perform this transformation, a few points (preferably three or more) in the topographic database must be referenced to the external reference system. These "control" points on a topographic survey have been previously established relative to an installation or project's primary control network. They normally were established using more accurate "geodetic control" survey procedures, such as differential leveling, static or kinematic DGPS observations, or total station traverse.

c. Most USACE topographic surveys require "control surveys" to bring in a geodetic reference network to the local project site where detailed topographic surveys are performed. It is important that the correct geodetic reference network is used, and that it is consistent with the overall installation or project reference system. It may also be important that these reference systems conform to regional or nationwide reference systems, such as the National Spatial Reference System (NSRS), North American Datum of 1983 (NAD 83), or the North American Vertical Datum of 1988 (NAVD 88). These various reference datums and systems are discussed in this chapter.

d. Not all topographic surveys require a rigid reference to some local or regional geographic coordinate system, and thus do not need time consuming and expensive preliminary control surveys. Some project feature or on going construction applications may only require a simple local reference--for example, a single monument with assumed or scaled coordinates and an arbitrary reference azimuth may suffice.

e. Other topographic surveys outside Army installations or Corps civil project areas may require rigid references to established property boundaries (corner pins, section corners, road intersections/centerlines, etc.). These ties to legal boundaries and corners will thus establish the reference system by which all topographic survey features are detailed. Regional geodetic or SPCS networks may or may not be required on such surveys, depending on local practice or statute.

f. For additional details on geodetic datums and coordinate systems, refer to EM 1110-1-1003 (*NAVSTAR GPS Surveying*) or consult one of the technical references listed in Appendix A.

SECTION I Geodetic Reference Systems

5-2. General

The discipline of surveying consists of locating points of interest on the surface of the earth. The positions of points of interest are defined by coordinate values that are referenced to a predefined mathematical surface. In geodetic surveying, this mathematical surface is called a datum, and the position of a point with respect to the datum is defined by its coordinates. The reference surface for a system of control points is specified by its position with respect to the earth and its size and shape. A datum is a coordinate surface used as reference figure for positioning control points. Control points are points with known relative positions tied together in a network. Densification of the network refers to adding more fixed control points to the network. Both horizontal and vertical datums are commonly used in surveying and mapping to reference coordinates of points in a network. Reference systems can be based on the geoid, ellipsoid, or a plane. The physical earth's gravity force can be modeled to create a positioning reference frame that rotates with the earth. The geoid is such a surface (an equipotential surface of the earth's gravity field) that best approximates Mean Sea Level (MSL). The orientation of this surface at a given point on geoid is defined by the plumb line. The plumb line is oriented tangent to the local gravity vector. Surveying instruments can be readily oriented with respect to the gravity field because its physical forces can be sensed with simple mechanical devices. Such a reference surface is developed from an ellipsoid of revolution that best approximates the geoid. An ellipsoid of revolution provides a well-defined mathematical surface to calculate geodetic distances, azimuths, and coordinates.

5-3. Geodetic Coordinates

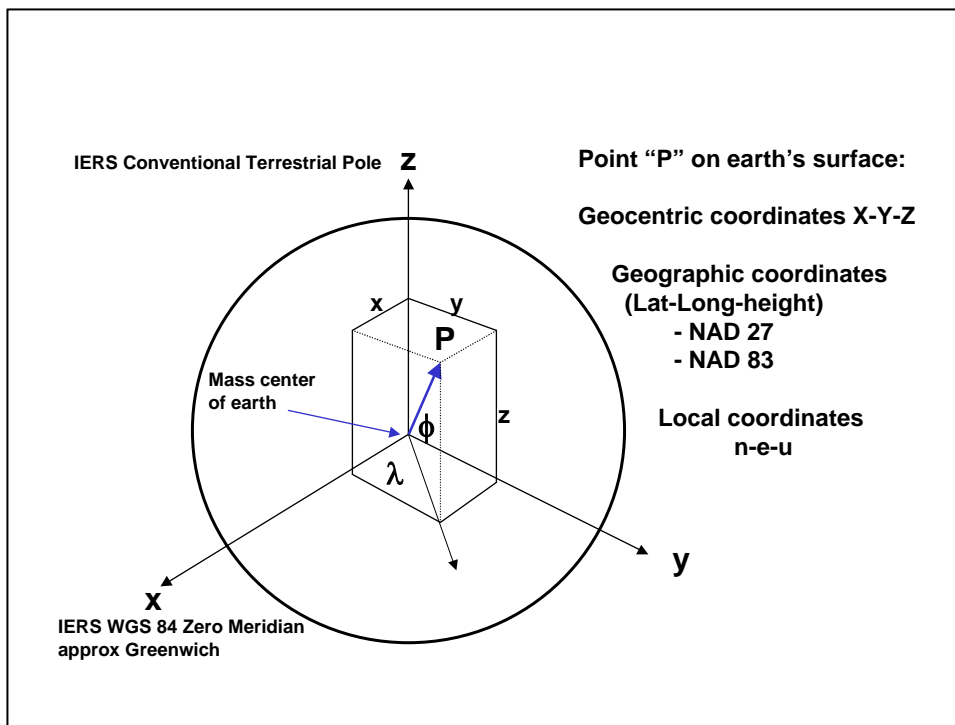

Figure 5-1. Earth-centered earth-fixed coordinate reference frames

A coordinate system is defined by the location of the origin, orientation of its axes, and the parameters (coordinate components) which define the position of a point within the coordinate system. Terrestrial coordinate systems are widely used to define the position of points on the terrain because they are fixed to the earth and rotate with it. The origin of terrestrial systems can be specified as either geocentric (origin at the center of the earth, such as NAD 83) or topocentric (origin at a point on the surface of the earth, such as NAD 27). The orientation of terrestrial coordinate systems is described with respect to its poles, planes, and axes. The primary pole (Z in Figure 5-1 above) is the axis of symmetry of the coordinate system, usually parallel to the rotation axis of the earth, and coincident with the semi-minor axis of the reference ellipsoid. The reference planes that are perpendicular to the primary polar axis are the equator (zero latitude) and the Greenwich meridian plane (zero longitude). Parameters for point positioning within a coordinate system refer to the coordinate components of the system (either Cartesian or curvilinear).

a. *Geocentric coordinates.* Geocentric coordinates have an origin at the center of the earth, as shown above in Figure 5-1. GPS coordinates are initially observed on this type of reference system. For example, a coordinate on such a system might be displayed on a GPS receiver as:

$$\begin{aligned} X &= 668400.506 \text{ m} \\ Y &= -4929214.152 \text{ m} \\ Z &= 3978967.747 \text{ m} \end{aligned}$$

GPS receivers will transform these geocentric coordinates into a geographic coordinate system described below.

b. *Geodetic or Geographic coordinates.* Geographic coordinate components consist of:

- latitude (ϕ),
- longitude (λ),
- ellipsoid height (h).

Geodetic latitude, longitude, and ellipsoid height define the position of a point on the surface of the Earth with respect to some “reference ellipsoid.” The most common reference ellipsoid used today is the WGS 84, which will be described in more detail in a later section.

(1) Geodetic latitude (ϕ). The geodetic latitude of a point is the acute angular distance between the equatorial plane and the normal through the point on the ellipsoid measured in the meridian plane (Figure 5-1). Geodetic latitude is positive north of the equator and negative south of the equator.

(2) Geodetic longitude (λ). The geodetic longitude is the angle measured counter-clockwise (east), in the equatorial plane, starting from the prime meridian (Greenwich meridian), to the meridian of the defined point (Figure 5-1). In the continental United States, longitude is commonly reported as a west longitude. To convert easterly to westerly referenced longitudes, the easterly longitude must be subtracted from 360 deg.

East-West Longitude Conversion:

$$\lambda (W) = [360 - \lambda (E)] \tag{Eq 5-1}$$

For example:

$$\lambda (E) = 282^{\text{d}} 52^{\text{m}} 36.345^{\text{s}} \text{ E}$$

$$\lambda (W) = [360^{\text{d}} - 282^{\text{d}} 52^{\text{m}} 36.345^{\text{s}} \text{ E}]$$
$$\lambda (W) = 77^{\text{d}} 07^{\text{m}} 23.655^{\text{s}} \text{ W}$$

(3) Ellipsoid Height (h). The ellipsoid height is the linear distance above the reference ellipsoid measured along the ellipsoidal normal to the point in question. The ellipsoid height is positive if the reference ellipsoid is below the topographic surface and negative if the ellipsoid is above the topographic surface.

(4) Geoid Separation (N). The geoid separation (or often termed "geoidal height") is the distance between the reference ellipsoid surface and the geoid surface measured along the ellipsoid normal. The geoid separation is positive if the geoid is above the ellipsoid and negative if the geoid is below the ellipsoid.

(5) Orthometric Height (H). The orthometric height is the vertical distance of a point above or below the geoid.

5-4. Datums

A datum is a coordinate surface used as reference for positioning control points. Both horizontal and vertical datums are commonly used in surveying and mapping to reference coordinates of points in a network.

a. Geodetic datum. Five parameters are required to define an ellipsoid-based datum. The major semi-axis (a) and flattening (f) define the size and shape of the reference ellipsoid; the latitude and longitude of an initial point; and a defined azimuth from the initial point define its orientation with respect to the earth. The NAD 27 and NAD 83 systems are examples of horizontal geodetic datums.

b. Horizontal datum. A horizontal datum is defined by specifying (1) the 2D geometric surface (plane, ellipsoid, sphere) used in coordinate, distance, and directional calculations, (2) the initial reference point (origin), and (3) a defined orientation, azimuth or bearing from the initial point. The "horizontal datum" for most topographic surveys is usually defined relative to the fixed control points (monuments and/or benchmarks) that were used to control the individual shots. These "control points" may, in turn, be referenced to a local installation/compound control network and/or to a regional NSRS CORS station.

c. Project datum. A project datum is defined relative to local control and might not be directly referenced to a geodetic datum. Project datums are usually defined by a system with perpendicular axes, and with arbitrary coordinates for the initial point, and with one (principal) axis oriented toward an assumed north. A chainage-offset system may also be used as a reference, with the PIs (points of intersection) either marked points or referenced to some other coordinate system.

d. Vertical datum. A vertical datum is a reference system used for reporting elevations. The two most common nationwide systems are the National Geodetic Vertical Datum of 1929 (NGVD 29) and the North American Vertical Datum of 1988 (NAVD 88). Vertical elevations used on navigation, flood control, and hydropower projects may also be referenced to a variety of datums, such as:

- Mean Sea Level (MSL)
- Mean Low Water (MLW)
- Mean Lower Low Water (MLLW)
- Mean High Water (MHW)
- International Great Lakes Datum (IGLD)

- Low Water Reference Plane (LWRP)
- Flat Pool Stage
- Local Pool or Reservoir Capacity Reference Point

Mean Sea Level (MSL) based elevations are used for most construction and topographic surveys--in particular those involving flood control or shoreline improvement/protection. It should be noted that MSL elevations are not the same as NGVD 29; and that MSL and NGVD 29 elevations can widely differ from NAVD 88 elevations--as much as 3 ft in western CONUS. MLLW elevations are used in referencing coastal navigation projects. MHW elevations are used in construction projects involving bridges and other crossings over navigable waterways.

e. The National Spatial Reference System (NSRS). The NSRS is that component of the National Spatial Data Infrastructure (NSDI) - [<http://www.fgdc.gov/nsdi/nsdi.html>] which contains all geodetic control contained in the National Geodetic Survey (NGS) database. This includes: A, B, First, Second and Third-Order horizontal and vertical control, geoid models, precise GPS orbits and Continuously Operating Reference Stations (CORS), and the National Shoreline as observed by NGS as well as data submitted by other Federal, State, and local agencies, academic institutions, and the private sector.

5-5. WGS 84 Reference Ellipsoid

The WGS 84 ellipsoid is used to reference GPS satellite observations and is used to reduce observations onto the NAD 83 system. The origin of the WGS 84 Cartesian system is the earth's center of mass, as shown in Figure 5-1. The Z-axis is parallel to the direction of the Conventional Terrestrial Pole (CTP) for polar motion, as defined by the Bureau International Heure (BIH), and equal to the rotation axis of the WGS 84 ellipsoid. The X-axis is the intersection of the WGS 84 reference meridian plane and the CTP's equator, the reference meridian being parallel to the zero meridian defined by the BIH and equal to the X-axis of the WGS 84 ellipsoid. The Y-axis completes a right-handed, earth-centered, earth-fixed orthogonal coordinate system, measured in the plane of the CTP equator 90 degrees east of the X-axis and equal to the Y-axis of the WGS 84 ellipsoid. The DOD continuously monitors the origin, scale, and orientation of the WGS 84 reference frame and references satellite orbit coordinates to this frame. Updates are shown as WGS 84 (GXXX), where "XXX" refers to a GPS week number starting on 29 September 1996.

Prior to development of WGS 84, there were several reference ellipsoids and interrelated coordinate systems (datums) that were used by the surveying and mapping community. Table 5-1 lists just a few of these reference systems along with their mathematical defining parameters. Note that GRS 80 is the actual reference ellipsoid for NAD 83; however, the difference between GRS-80 and WGS 84 ellipsoids is insignificant. Transformation techniques are used to convert between different datums and coordinate systems. Most GPS software has built in transformation algorithms for the more common datums.

Table 5-1. Reference Ellipsoids and Related Coordinate Systems

Reference Ellipsoid	Coordinate System (Datum/Frame)	Semimajor axis (meters)	Shape (1/flattening)
Clarke 1866	NAD 27	6378206.4	1/294.9786982
WGS 72	WGS 72	6378135	1/298.26
GRS 80	NAD 83 (XX)	6378137	1/298.257222101
WGS 84	WGS 84 (GXXX)	6378137	1/298.257223563
ITRS	ITRF (XX)	6378136.49	1/298.25645

5-6. Horizontal Datums and Reference Frames

The following paragraphs briefly describe the most common datums used to reference CONUS projects.

a. North American Datum of 1927 (NAD 27). NAD 27 is a horizontal datum based on a comprehensive adjustment of a national network of traverse and triangulation stations. NAD 27 is a best fit for the continental United States. The fixed datum reference point is located at Meades Ranch, Kansas. The longitude origin of NAD 27 is the Greenwich Meridian with a south azimuth orientation. The original network adjustment used 25,000 stations. The relative precision between initial point monuments of NAD 27 is by definition 1:100,000, but coordinates on any given monument in the network contain errors of varying degrees. As a result, relative accuracies between points on NAD 27 may be far less than the nominal 1:100,000. The reference units for NAD 27 are US Survey Feet. This datum is no longer supported by NGS, and USACE commands are gradually transforming their project coordinates over to the NAD 83 described below. Approximate conversions of points on NAD 27 to NAD 83 may be performed using CORPSCON, a transformation program developed by ERDC/TEC. Since NAD 27 contains errors approaching 10 m, transforming highly accurate GPS observations to this antiquated reference system is not the best approach.

b. North American Datum of 1983 (NAD 83). The nationwide horizontal reference network was redefined in 1983 and readjusted in 1986 by the National Geodetic Survey. It is known as the North American Datum of 1983, adjustment of 1986, and is referred to as NAD 83 (1986). NAD 83 used far more stations (250,000) and observations than NAD 27, including a few satellite-derived coordinates, to readjust the national network. The longitude origin of NAD 83 is the Greenwich Meridian with a north azimuth orientation. The fixed adjustment of NAD 83 (1986) has an average precision of 1:300,000. NAD 83 is based upon the Geodetic Reference System of 1980 (GRS 80), an earth-centered reference ellipsoid which for most (but not all) practical purposes is equivalent to WGS 84. With increasingly more accurate uses of GPS, the errors and misalignments in NAD 83 (1986) became more obvious (they approached 1 meter), and subsequent refinements outlined below have been made to correct these inconsistencies.

c. High Accuracy Reference Networks (HARN). (Figure 5-2). Within a few years after 1986, more refined GPS measurements had allowed geodesists to locate the earth's center of mass with a precision of a few centimeters. In doing so, these technologies revealed that the center of mass that was adopted for NAD 83 (1986) is displaced by about 2 m from the true geocenter. These discrepancies caused significant concern as the use of highly accurate GPS measurements proliferated. Starting with Tennessee in 1989, each state--in collaboration with NGS and various other institutions--used GPS technology to establish regional reference frames that were to be consistent with NAD 83. The corresponding networks of GPS control points were originally called High Precision Geodetic Networks (HPGN). Currently, they are referred to as High Accuracy Reference Networks (HARN). This latter name reflects the fact that relative accuracies among HARN control points are better than 1 ppm, whereas relative accuracies among pre-existing control points were nominally only 10 ppm. Positional differences between NAD 83 (1986) and NAD 83 (HARN) can approach 1 meter.

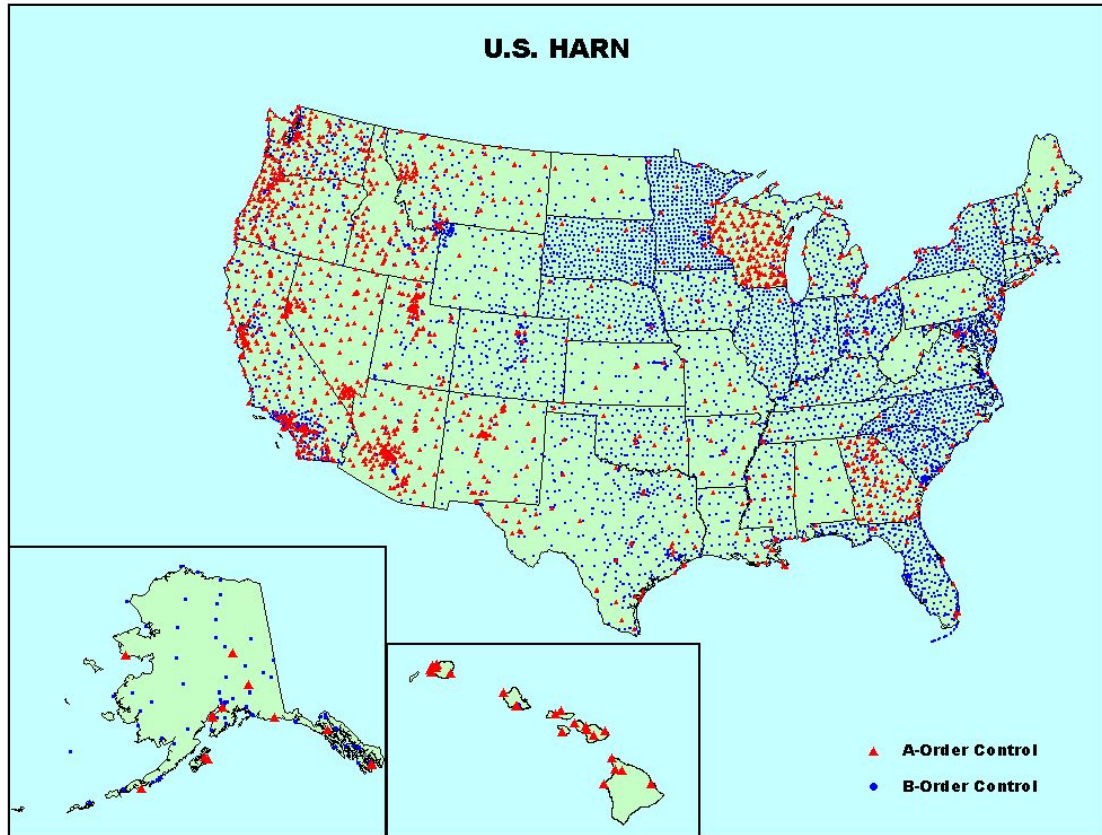

Figure 5-2. High Accuracy Reference Network control points

d. *Continuously Operating Reference Stations (CORS)*. The regional HARNs were subsequently further refined (or "realized") by NGS into a network of Continuously Operating Reference Stations, or CORS. This CORS network was additionally incorporated with the International Terrestrial Reference System (ITRS), i.e. the ITRF. CORS are located at fixed points throughout CONUS and at some OCONUS points--see Figure 5-3 below. This network of high-accuracy points can provide GPS users with centimeter level accuracy where adequate CORS coverage exists. Coordinates of CORS stations are designated by the year of the reference frame, e.g., NAD 83 (CORS 96). Positional differences between NAD 83 (HARN) and NAD 83 (CORS) are less than 10 cm. More importantly, positional difference between two NAD 83 (CORSxx) points is typically less than 2 cm. Thus, GPS connections to CORS stations will be of the highest order of accuracy. USACE commands can easily connect and adjust GPS-observed points directly with CORS stations using a number of methods, including the NGS on-line program OPUS (On-Line Positioning User Service)--see EM 1110-1-1003. CORS are particularly useful when precise control is required in a remote area, from which a topographic survey may be performed. With only 1 to 2 hours of static DGPS observations, reference points can often be established to an ellipsoid accuracy better than ± 0.2 ft in X-Y-Z.

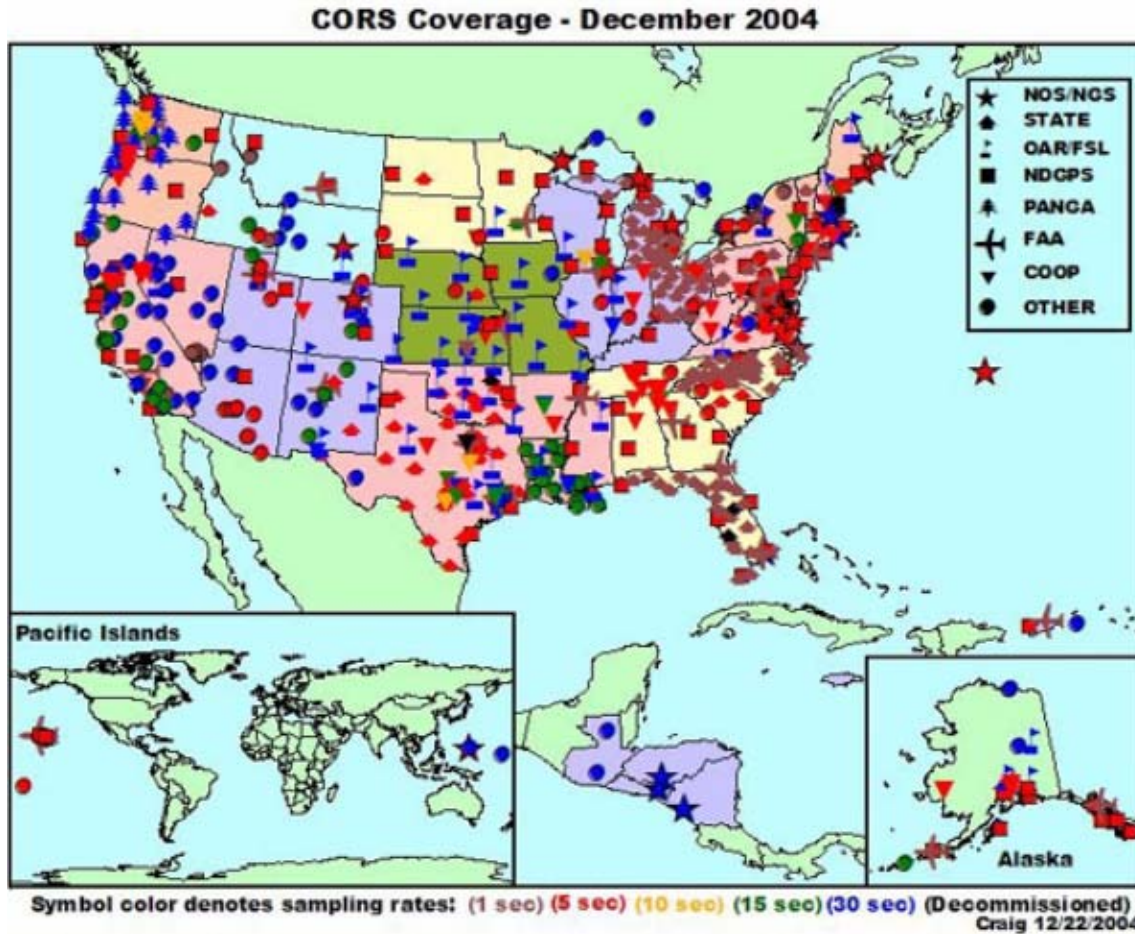

Figure 5-3. Continuously Operating Reference Stations as of 2001 (NGS)

e. International Terrestrial Reference Frame (ITRF). The ITRF is a highly accurate geocentric reference frame with an origin at the center of the earth's mass. The ITRF is continuously monitored and updated by the International Earth Rotation Service (IERS) using very-long-baseline-interferometry (VLBI) and other techniques. These observations allow for the determination of small movements of fixed points on the earth's surface due to crustal motion, rotational variances, tectonic plate movement, etc. These movements can average 10 to 20 mm/year in CONUS, and may become significant when geodetic control is established from remote reference stations. These refinements can be used to accurately determine GPS positions observed on the basic WGS 84 reference frame. NAD 83 coordinates are defined based on the ITRF year/epoch in which it is defined, e.g., ITRF 89, ITRF 96, ITRF 2000. For highly accurate positioning where plate velocities may be significant, users should use the same coordinate reference frame and epoch for both the satellite orbits and the terrestrial reference frame. USACE requirements for these precisions on control surveys would be rare, and would never be applicable to local facility mapping surveys. Those obtaining coordinates from NGS datasheets must take care not to use ITRF values. The relationship between ITRF, NAD 83, and the geoid is illustrated in Figure 5-4 below.

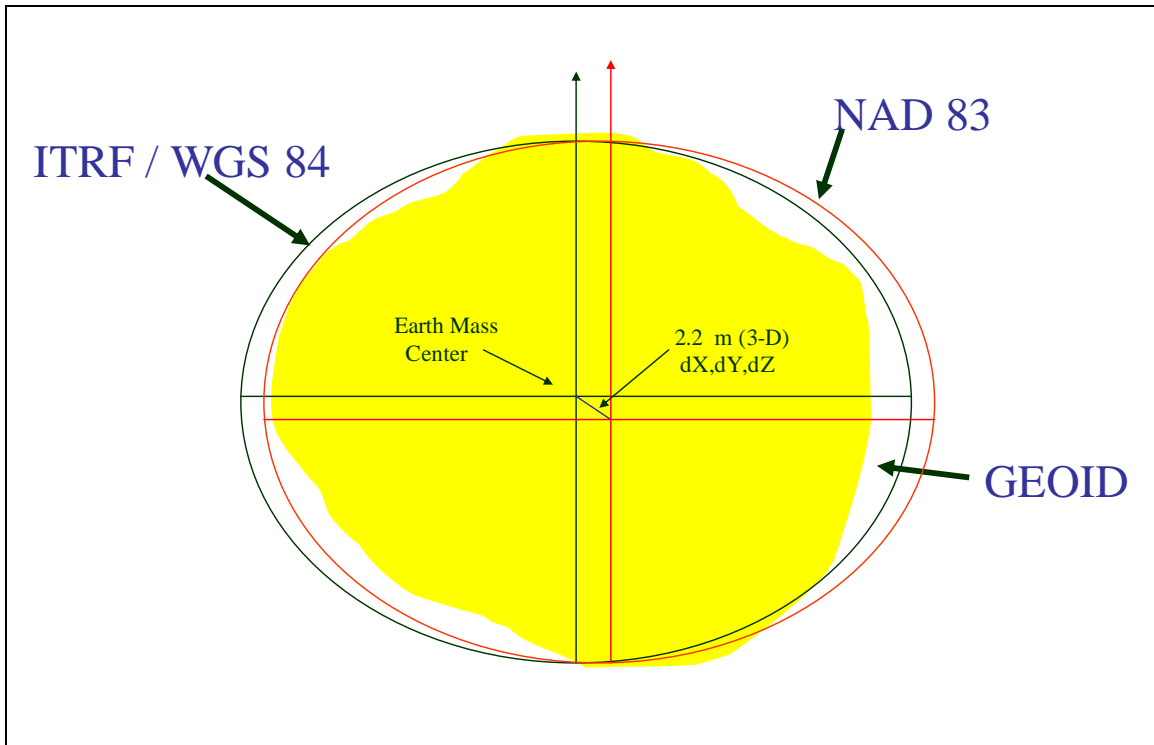

Figure 5-4. Relationship between ITRF, NAD 83, and the geoid

SECTION II Horizontal Coordinate Systems

5-7. General

Geocentric, geographic, or geodetic coordinates described above are rarely used to reference site plan topographic surveys or maps. Engineering site plan drawings are normally referenced to a local state plane coordinate system (SPCS), or in some cases a metric-based UTM system. In rare cases, they may be referenced to an arbitrary coordinate system relative to some point on the project--a monument, corner, road intersection, etc. In most cases, control surveys performed for setting project control will be computed and adjusted using the SPCS. The following paragraphs describe horizontal coordinate systems commonly used on facility site plan mapping and related control surveys.

5-8. Geographic Coordinates

The use of geographic coordinates as a system of reference is accepted worldwide. It is based on the expression of position by latitude (parallels) and longitude (meridians) in terms of arc (degrees, minutes, and seconds) referred to the equator (north and south) and a prime meridian (east and west). The degree of accuracy of a geographic reference (GEOREF) is influenced by the map scale and the accuracy requirements for plotting and scaling. Examples of GEOREFs are as follows:

- 40° N 132° E (referenced to degrees of latitude and longitude).
- 40°21' N 132°14' E (referenced to minutes of latitude and longitude).
- 40°21'12" N 132°14'18" E (referenced to seconds of latitude and longitude).
- 40°21'12.4" N 132°14'17.7" E (referenced to tenths of seconds of latitude and longitude).
- 40°21'12.45" N 132°14'17.73" E (referenced to hundredths of seconds of latitude and longitude).

US military maps and charts include a graticule (parallels and meridians) for plotting and scaling geographic coordinates. Graticule values are shown in the map margin. On maps and charts at scales of 1:250,000 and larger, the graticule may be indicated in the map interior by lines or ticks at prescribed intervals (for example, scale ticks and interval labeling at the corners of 1:50,000 at 1 minute [in degrees, minutes, and seconds] and again every 5 minutes).

5-9. State Plane Coordinate Systems

a. General. State Plane Coordinate Systems (SPCS) were developed by the National Geodetic Survey (NGS) to provide plane coordinates over a limited region of the earth's surface. To properly relate geodetic coordinates (ϕ - λ - h) of a point to a 2D plane coordinate representation (Northing, Easting), a conformal mapping projection must be used. Conformal projections have mathematical properties that preserve differentially small shapes and angular relationships to minimize the errors in the transformation from the ellipsoid to the mapping plane. Map projections that are most commonly used for large regions are based on either a conic or a cylindrical mapping surface (Figure 5-5 below). The projection of choice is dependent on the north-south or east-west areal extent of the region. Areas with limited east-west dimensions and indefinite north-south extent use the Transverse Mercator (TM) type projection. Areas with limited north-south dimensions and indefinite east-west extent use the Lambert projection. The SPCS is designed to minimize the spatial distortion at a given point to approximately one part in ten thousand (1:10,000). To satisfy this criteria, the SPCS has been divided into zones that have a maximum width or height of approximately one hundred and fifty eight statute miles (158 miles). Therefore, each state may have several zones or may employ both the Lambert (conic) and Transverse Mercator

(cylindrical) projections. The projection state plane coordinates are referenced to a specific geodetic datum (i.e. the datum that the initial geodetic coordinates are referenced to must be known).

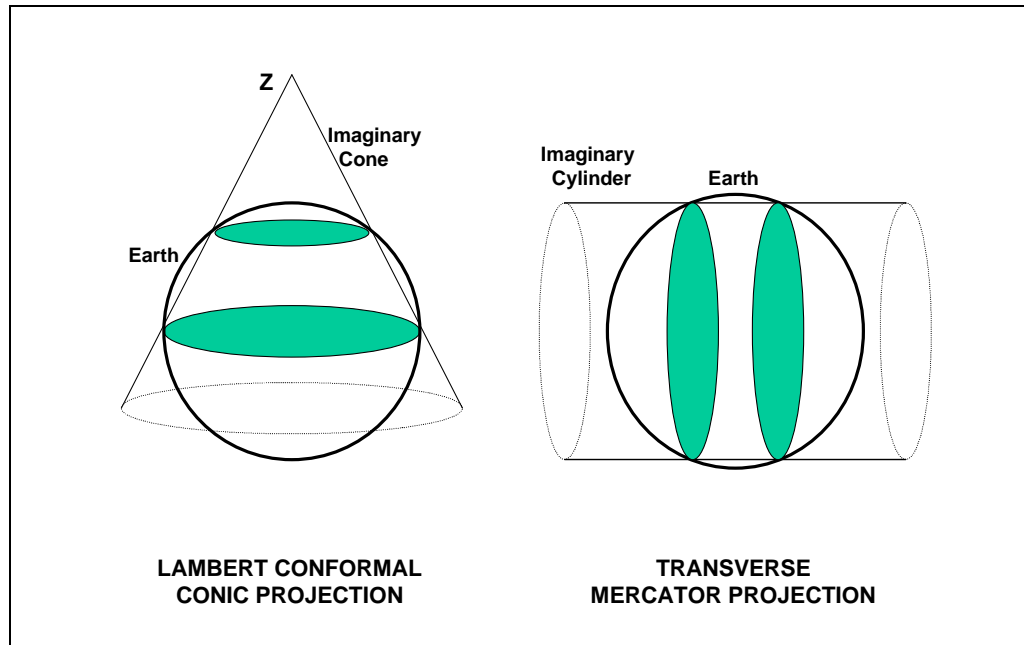

Figure 5-5. Common map projections

b. Transverse Mercator (TM). The Transverse Mercator projection uses a cylindrical surface to cover limited zones on either side of a central reference longitude. Its primary axis is rotated perpendicular to the symmetry axis of the reference ellipsoid. Thus, the TM projection surface intersects the ellipsoid along two lines equidistant from the designated central meridian longitude (Figure 5-6). Distortions in the TM projection increase predominantly in the east-west direction. The scale factor for the Transverse Mercator projection is unity where the cylinder intersects the ellipsoid. The scale factor is less than one between the lines of intersection, and greater than one outside the lines of intersection. The scale factor is the ratio of arc length on the projection to arc length on the ellipsoid. To compute the state plane coordinates of a point, the latitude and longitude of the point and the projection parameters for a particular TM zone or state must be known.

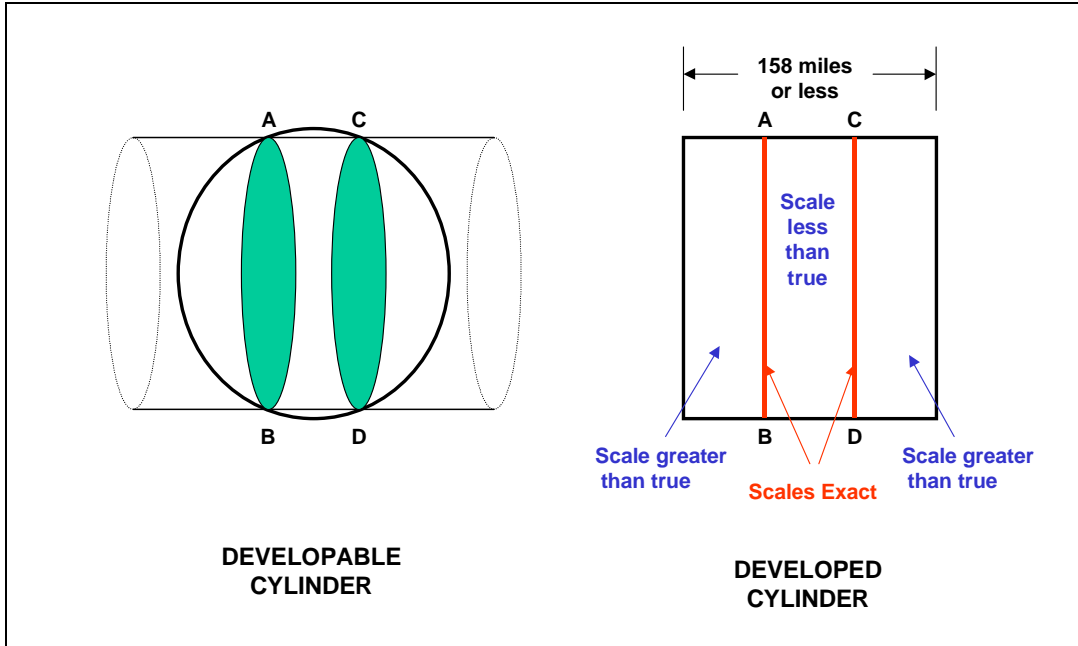

Figure 5-6. Transverse Mercator Projection

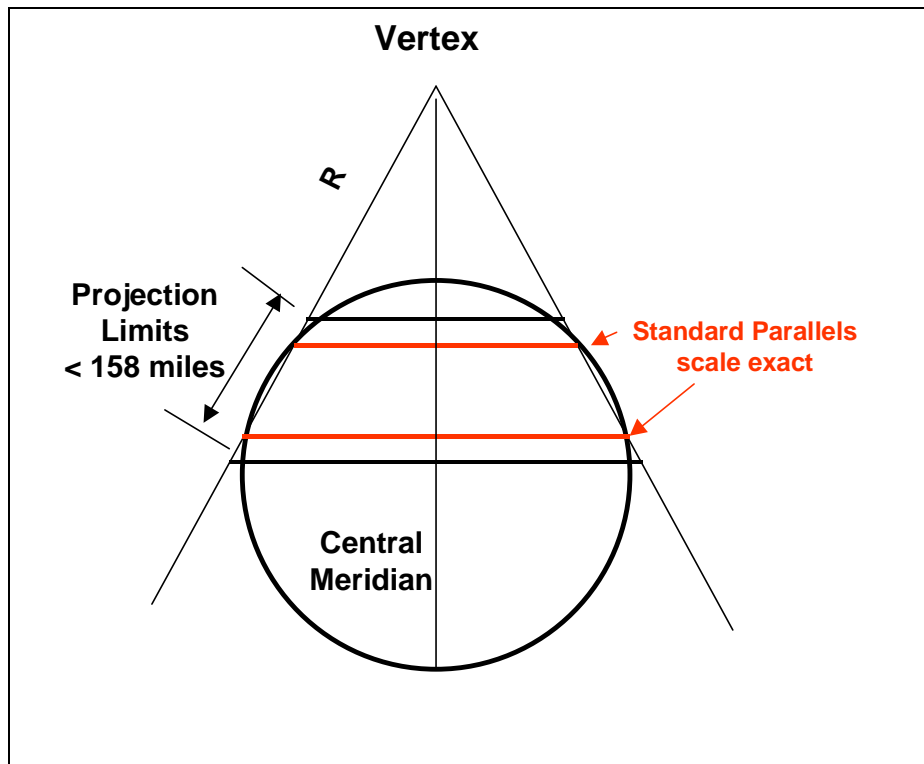

Figure 5-7. Lambert Projection

c. *Lambert Conformal Conic (LCC)*. The Lambert projection uses a conic surface to cover limited zones of latitude adjacent to two parallels of latitude. Its primary axis is coincident with the symmetry axis of the reference ellipsoid. Thus, the LCC projection intersects the ellipsoid along two standard parallels (Figure 5-7). Distortions in the LCC projection increase predominantly in the north-south direction. The scale factor for the Lambert projection is equal to unity at each standard parallel and is less than one inside, and greater than one outside the standard parallels. The scale factor remains constant along the standard parallels.

d. *SPCS zones*. Figure 5-8 depicts the various SPCS zones in the US. The unique state zone number provides a standard reference when using transformation software developed by NGS and the COE. The state zone number remains constant in both NAD27 and NAD83 coordinate systems.



Figure 5-8. SPCS zones identification numbers for the various states

e. *Scale units*. State plane coordinates can be expressed in both feet and meters. State plane coordinates defined on the NAD 27 datum are published in feet. State plane coordinates defined on the NAD 83 datum are published in meters; however, state and federal agencies can request the NGS to provide coordinates in feet. If NAD 83 based state plane coordinates are defined in meters and the user intends to convert those values to feet, the proper meter-feet conversion factor must be used. Some states use the International Survey Foot rather than the US Survey Foot in the conversion of feet to meters.

International Survey Foot:

$$1 \text{ International Foot} = 0.3048 \text{ meter (exact)}$$

US Survey Foot:

$$1 \text{ US Survey Foot} = 1200 / 3937 \text{ meter (exact)}$$

5-10. Grid Elevations, Scale Factors, and Convergence

In all planer grid systems, the grid projection only approximates the ellipsoid (or roughly the ground), and “ground-grid” corrections must be made for measured distances or angles (directions). Measured ground distances must be corrected for (1) elevation (sea level factor), and (2) ground to grid plane (scale factor). Figure 5-9 below illustrates a reduction of a measured distance (D) down to the ellipsoid distance (S). Not shown is the subsequent reduction from the ellipsoid length to a grid system length. Observed directions (or angles) must also be corrected for grid convergence. Also shown on the figure is the relationship between ellipsoid heights (h), geoid heights (N), and orthometric heights (H).

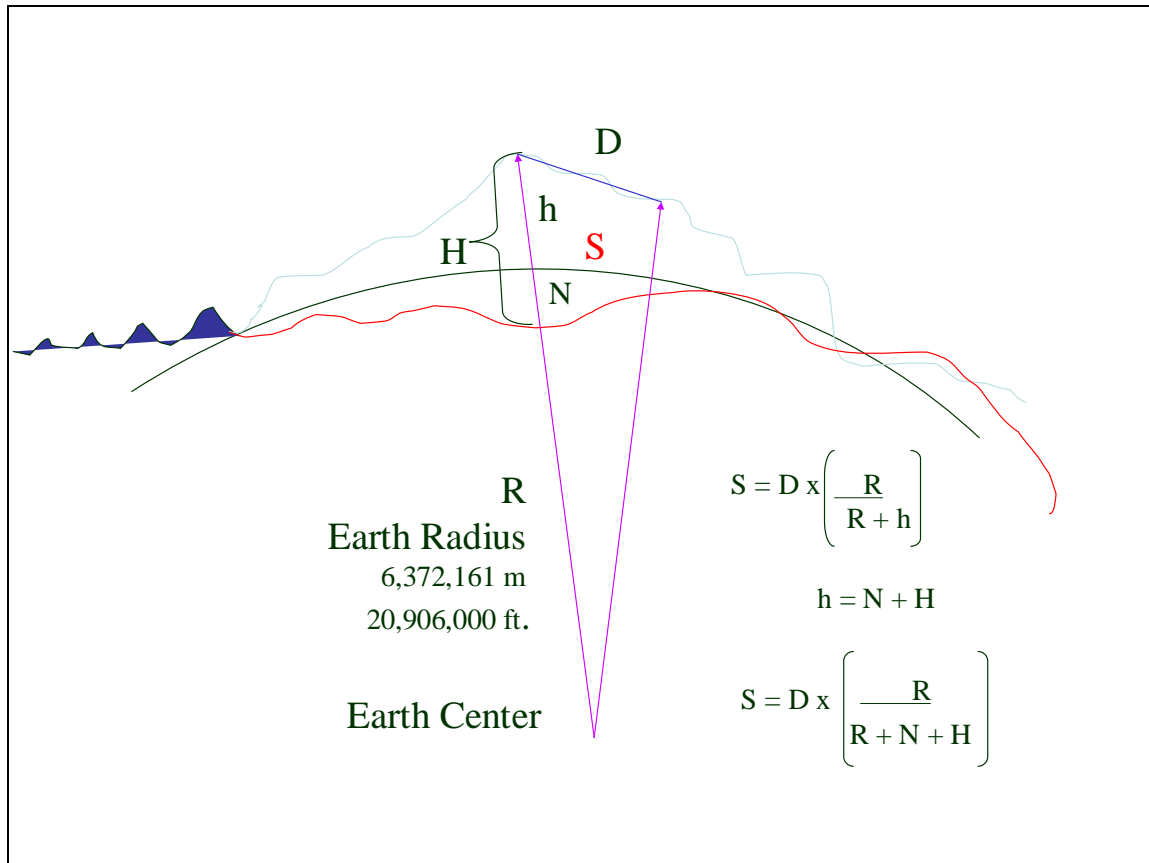

Figure 5-9. Reduction of measured slope distance D to ellipsoid distance S (NGS)

a. *Grid factor.* For most topographic surveys covering a small geographical site, these two factors can be combined into a constant “grid factor”--reference Kavanagh 1997:

$$\text{Grid factor} = \text{Sea Level Factor} \times \text{Scale Factor}$$

then: $\text{Ground Distance} = \text{Grid Distance} / \text{Grid Factor}$

or

$$\text{Grid Distance} = \text{Ground Distance} \times \text{Grid Factor}$$

b. *Convergence.* Between two fixed points, the geodetic azimuth will differ from the grid azimuth. This difference is known as “convergence” and varies with the distance from the central

meridian of the projection. Thus, if a geodetic azimuth is given between two fixed points (inversed from published geographic coordinates, astronomic, or GPS), then it must be corrected for convergence to obtain an equivalent grid azimuth. If lengthy control traverses are being computed on a SPCS or UTM grid, then additional second term corrections to observed angles may be required--e.g., the "t-T" correction used in older survey manuals at Appendix A-4 (TM 5-237 and TM 5-241-2).

c. Use of data collectors. The above grid corrections should rarely have to be performed when modern survey data collectors are being used. These total station or RTK data collectors (with full COGO and adjustment capabilities) will automatically perform all the necessary geographic to grid coordinate translations, including sea level reductions and local grid system conversions that are later transformed and adjusted into an established SPCS grid at a true elevation. If for some reason you are not using a data collector that seamlessly performs these translation functions, and you are performing a survey in higher elevations, then you must correct original distance observations for the sea level reduction. If you transfer these observed distances and angles to a SPCS or UTM grid, then you must correct for grid scale factor and convergence described above. Consult any of the referenced surveying textbooks at Appendix A-2 for procedures and examples.

5-11. Universal Transverse Mercator Coordinate System

Universal Transverse Mercator (UTM) coordinates are used in surveying and mapping when the size of the project extends through several state plane zones or projections. UTM coordinates are also utilized by the US Army, Air Force, and Navy for tactical mapping, charting, and geodetic applications. It may also be used to reference site plan engineering surveys if so requested in CONUS or OCONUS installations. The UTM projection differs from the TM projection in the scale at the central meridian, origin, and unit representation. The scale at the central meridian of the UTM projection is 0.9996. In the Northern Hemisphere, the northing coordinate has an origin of zero at the equator. In the Southern Hemisphere, the southing coordinate has an origin of ten million meters (10,000,000 m). The easting coordinate has an origin five hundred thousand meters (500,000 m) at the central meridian. The UTM system is divided into sixty (60) longitudinal zones. Each zone is six (6) degrees in width extending three (3) degrees on each side of the central meridian. UTM coordinates are always expressed in meters. USACE program CORPSCON can be used to transform coordinates between UTM and SPCS systems. Additional details on UTM grids and survey computations thereon may be found in the older DA references listed at Appendix A-4.

5-12. The US Military Grid-Reference System (FM 3-34.331)

The US Military Grid-Reference System (MGRS) is designed for use with UTM grids. For convenience, the earth is generally divided into 6° by 8° geographic areas, each of which is given a unique grid-zone designation. These areas are covered by a pattern of 100,000-meter squares. Two letters (called the 100,000-meter-square letter identification) identify each square. This identification is unique within the area covered by the grid-zone designation.

a. The MGRS is an alphanumeric version of a numerical UTM grid coordinate. Thus, for that portion of the world where the UTM grid is specified (80° south to 84° north), the UTM grid-zone number is the first element of a military grid reference. This number sets the zone longitude limits. The next element is a letter that designates a latitude band. Beginning at 80° south and proceeding northward, 20 bands are lettered C through X. In the UTM portion of the MGRS, the first three characters designate one of the areas within the zone dimensions.

b. A reference that is keyed to a gridded map (of any scale) is made by giving the 100,000-meter-square letter identification together with the numerical location. Numerical references within the

EM 1110-1-1005
1 Jan 07

100,000-meter square are given to the desired accuracy in terms of the easting and northing grid coordinates for the point.

c. The final MGRS position coordinate consists of a group of letters and numbers that include the following elements:

- The grid-zone designation.
- The 100,000-meter-square letter identification.
- The grid coordinates (also referred to as rectangular coordinates) of the numerical portion of the reference, expressed to a desired refinement.
- The reference is written as an entity without spaces, parentheses, dashes, or decimal points.

Examples are as follows:

18S (locating a point within the grid-zone designation).
18SUU (locating a point within a 100,000-meter square).
18SUU80 (locating a point within a 10,000-meter square).
18SUU8401 (locating a point within a 1,000-meter square).
18SUU836014 (locating a point within a 100-meter square).

d. To satisfy special needs, a reference can be given to a 10-meter square and a 1-meter square.

Examples are as follows:

8SUU83630143 (locating a point within a 10-meter square).
18SUU8362601432 (locating a point within a 1-meter square).

e. There is no zone number in the polar regions. A single letter designates the semicircular area and the hemisphere. The letters A, B, Y, and Z are used only in the polar regions. An effort is being made to reduce the complexity of grid reference systems by standardizing a single, worldwide grid reference system.

5-13. US National Grid System

A US National Grid (USNG) system has been developed to improve public safety, commerce, and aid the casual GPS user with an easy to use geocode system for identifying and determining location with the help of a USNG gridded map and/or a USNG enabled GPS system. The USNG can provide for whatever level of precision is desired. Many users may prefer to continue using the UTM format for applications requiring precision greater than 1 meter.

a. *Grid Zone Designation (GZD)*. The US geographic area is divided into 6-degree longitudinal zones designated by a number and 8-degree latitudinal bands designated by a letter. Each area is given a unique alphanumeric Grid Zone Designator--e.g., 18S.

b. *100,000-meter square identification*. Each GZD 6x8 degree area is covered by a specific scheme of 100,000-meter squares where each square is identified by two unique letters--e.g., 18SUJ identifies a specific 100,000-meter square in the specified GZD.

c. *Grid coordinates*. A point position within the 100,000-meter square shall be given by the UTM grid coordinates in terms of its Easting (E) and Northing (N). An equal number of digits shall be used for

E and N where the number of digits depends on the precision desired in position referencing. In this convention, the reading shall be from left with Easting first and then Northing.

Examples:

18SUJ20 - Locates a point with a precision of 10 km

18SUJ2306 - Locates a point with a precision of 1 km

18SUJ234064 - Locates a point with a precision of 100 meters

18SUJ23480647 - Locates a point with a precision of 10 meters

18SUJ2348306479 - Locates a point with a precision of 1 meter

The number of digits in Easting and Northing can vary, depending on specific requirements or application.

5-14. Chainage-Offset Coordinate Systems

Most linear engineering and construction projects (roads, railways, canals, navigation channels, levees, floodwalls, beach renourishment, etc.) are locally referenced using the traditional engineering chainage-offset system--Figure 5-10. Usually, SPCS coordinates are provided at the PIs, from which (given the alignment between PIs) a SPCS coordinate can then be computed for any given station-offset point. Chainage-offset systems are used for locating cross-sections along even centerline stations. Topographic elevation and feature data is then collected along each section relative to the centerline. Likewise, road, canal, levee alignments can be staked out relative to station-offset parameters, and internally in a total station or RTK system data collector, these offsets may actually be transformed from a SPCS.

a. Station. Alignment stationing (or chainage) zero references are arbitrarily established for a given project or sectional area. Stationing on a navigation project usually commences offshore on coastal projects and runs inland or upstream. Stationing follows the channel centerline alignment. Stationing may be accumulated through each PI or zero out at each PI or new channel reach. Separate stationing is established for widener sections, turning basins, levees, floodwalls, etc. Each district may have its own convention. Stationing coordinates use “+” signs to separate the second- and third-place units (XXX + XX.XX). Metric chainage often separates the third and fourth places (XXX + XXX.XX) to distinguish the units from English feet; however, some districts use this convention for English stationing units.

b. Offsets. Offset coordinates are distances from the centerline alignment. Offsets carry plus/minus coordinate values. Normally, offsets are positive to the right (looking toward increasing stationing). Some USACE Districts designate cardinal compass points (east-west or north-south) in lieu of a coordinate sign. On some navigation projects, the offset coordinate is termed a “range,” and is defined relative to the project centerline or, in some instances, the channel-slope intersection line (toe). Channel or canal offsets may be defined relative to a fixed baseline on the bank or levee.

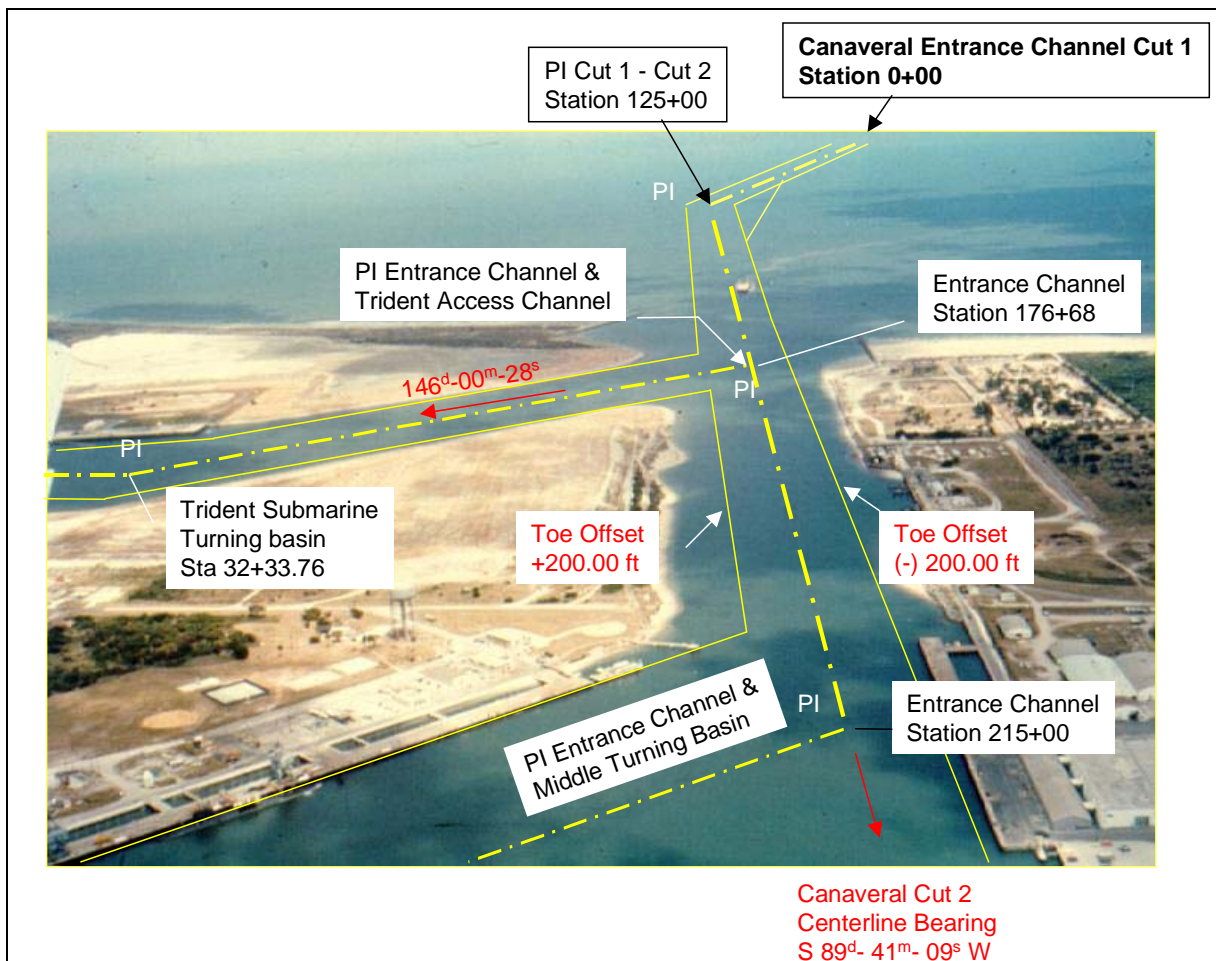

Figure 5-10. Chainage-offset project control scheme for a typical deep-draft navigation project--Cape Canaveral, FL (Jacksonville District)

c. *Azimuth.* Azimuths are computed relative to the two defining PIs. Either 360-deg azimuth or bearing designations may be used. Azimuths should be shown to the nearest second.

d. *Other local alignments.* Different station-offset reference grids may be established for individual portions of a project. River sections and coastal beach sections are often aligned perpendicular to the project/coast. Each of these sections is basically a separate local datum with a different reference point and azimuth alignment. Beach sections may also be referenced to an established coastal construction setback line. Circular and transition (spiral) curve alignments are also found in some rivers, canals, and flood control projects such as spillways and levees. Surveys will generally be aligned to the chainage and offsets along such curves. Along inland waterways, such as the Mississippi River, stationing is often referenced to either arbitrary or monumented baselines along the bank. In many instances, a reference baseline for a levee is used, and surveys for revetment design and construction are performed from offsets to this line. Separate baselines may exist over the same section of river, often from levees on opposite banks or as the result of revised river flow alignments. Baseline stationing may increase either upstream or downstream. Most often, the mouth of a river is considered the starting point (Station 0 + 00), or the river reaches are summed to assign a station number at the channel confluence. Stationing may increase consecutively through PIs or reinitialize at channel turns. In addition,

supplemental horizontal reference may also be made to a river mile designation system. River mile systems established years ago may no longer be exact if the river course has subsequently realigned itself. River mile designations can be used to specify geographical features and provide navigation reference for users.

5-15. Datum Conversions and Transformation Methods

a. General. Federal Geodetic Control Subcommittee (FGCS) members, which includes USACE, have adopted NAD 83 as the standard horizontal datum for surveying and mapping activities performed or financed by the Federal government. To the extent practicable, legally allowable, and feasible, USACE should use NAD 83 in its surveying and mapping activities. Transformations between NAD 27 coordinates and NAD 83 coordinates are generally obtained using the CORPS Convert (CORPSCON) software package or other North American Datum Conversion (e.g., NADCON) based programs.

b. Conversion techniques. USACE survey control published in the NGS control point database has been already converted to NAD 83 values. However, most USACE survey control was not originally in the NGS database and was not included in the NGS readjustment and redefinition of the national geodetic network. Therefore, USACE will have to convert this control to NAD 83. Coordinate conversion methods considered applicable to USACE projects are discussed below.

(1) Resurvey from NAD 83 Control. A new survey using NGS published NAD 83 control could be performed over the entire project. This could be either a newly authorized project or one undergoing major renovation or maintenance. Resurvey of an existing project must tie into all monumented points. Although this is not a datum transformation technique, and would not normally be economically justified unless major renovation work is being performed, it can be used if existing NAD 27 control is of low density or accuracy.

(2) Readjustment of Survey. If the original project control survey was connected to NGS control stations, the survey may be readjusted using the NAD 83 coordinates instead of the NAD 27 coordinates originally used. This method involves locating the original field notes and observations, and completely readjusting the survey and fixing the published NAD 83 control coordinates.

(3) Mathematical Transformations. Since neither of the above methods can be economically justified on most USACE projects, mathematical approximation techniques for transforming project control data to NAD 83 have been developed. These methods yield results which are normally within ± 1 ft of the actual values and the distribution of errors are usually consistent within a local project area. Since these coordinate transformation techniques involve approximations, they should be used with caution when real property demarcation points and precise surveying projects are involved. When mathematical transformations are employed they should be adequately noted so that users will be aware of the conversion method.

c. Horizontal datum transformation methods. Coordinate transformations from one geodetic reference system to another can be most practically made either by using a local seven-parameter transformation or by interpolation of datum shift values across a given region.

(1) Seven parameter transformations. For worldwide (OCONUS) and local datum transformations, one of the referenced textbooks at Section A-2 should be consulted.

(2) Grid-shift transformations. Current methods for interpolation of datum shift values use the difference between known coordinates of common points from both the NAD 27 and NAD 83 adjustments to model a best-fit shift in the regions surrounding common points. A grid of approximate

datum shift values is established based on the computed shift values at common points in the geodetic network. The datum shift values of an unknown point within a given grid square are interpolated along each axis to compute an approximate shift value between NAD 27 and NAD 83. Any point that has been converted by such a transformation method should be considered as having only approximate NAD 83 coordinates.

(3) NADCON/CORPSCON. NGS developed the transformation program NADCON, which yields consistent NAD 27 to NAD 83 coordinate transformation results over a regional area. This technique is based on the above grid-shift interpolation approximation. NADCON was reconfigured into a more comprehensive program called CORPSCON. Technical documentation and operating instructions for CORPSCON can be obtained at the following ERDC Web site: <http://crunch.tec.army.mil>. This software converts between:

NAD 27	NAD 83	SPCS 27	SPCS 83
UTM 27	UTM 83	NGVD 29	NAVD 88
GEOID03	HARN		

Since the overall CORPSCON datum shift (from point to point) varies throughout North America, the amount of datum shift across a local project is also not constant. The variation can be as much as 0.1 ft per mile. Examples of some NAD 27 to NAD 83 based coordinate shift variations that can be expected over a 10,000-ft section of a project are shown below:

Project Area	SPCS Reference	Per 10,000 feet
Baltimore, MD	1900	0.16 ft
Los Angeles, CA	0405	0.15 ft
Mississippi Gulf Coast	2301	0.08 ft
Mississippi River (IL)	1202	0.12 ft
New Orleans, LA	1702	0.22 ft
Norfolk, VA	4502	0.08 ft
San Francisco, CA	0402	0.12 ft
Savannah, GA	1001	0.12 ft
Seattle, WA	4601	0.10 ft

Such local scale changes will cause project alignment data to distort by unequal amounts. Thus, a 10,000-ft tangent on NAD 27 project coordinates could end up as 9,999.91 feet after mathematical transformation to NAD 83 coordinates. Although such differences may not be appear significant from a lower-order construction survey standpoint, the potential for such errors must be recognized. Therefore, the transformations will not only significantly change absolute coordinates on a project and the datum transformation process will slightly modify the project's design dimensions and/or construction orientation and scale. For example, on a navigation project, an 800.00-ft wide channel could vary from 799.98 to 800.04 feet along its reach. This variation could also affect grid alignment azimuths. Moreover, if the local SPCS 83 grid was further modified, then even larger dimension changes can result. Correcting for distortions may require recomputation of coordinates after conversion to ensure original project dimensions and alignment data remain intact. This is particularly important for property and boundary surveys. A less accurate alternative is to compute a fixed shift to be applied to all data points over a limited area. Determining the maximum area over which such a fixed shift can be applied is important. Computing a fixed conversion factor with CORPSCON can be made to within ± 1 foot. Typically, this fixed conversion would be computed at the center of a sheet or at the center of a project and the conversions in X and Y from NAD 27 to NAD 83 and from SPCS 27 to SPCS 83 indicated by notes on the sheets or data sets. Since the conversion is not constant over a given area, the fixed conversion amounts must be explained in the note. The magnitude of the conversion factor change across

a sheet is a function of location and the drawing scale. Whether the magnitude of the distortion is significant depends on the nature of the project. For example, a 0.5-ft variation on an offshore navigation project may be acceptable for converting depth sounding locations, whereas a 0.1-ft change may be intolerable for construction layout on an installation. In any event, the magnitude of this gradient should be computed by CORPSCON at each end (or corners) of a sheet or project. If the conversion factor variation exceeds the allowable tolerances, then a fixed conversion factor should not be used. Two examples of using Fixed Conversion Factors follow:

Example 1. Assume a 1 inch = 40 ft scale site plan map on existing SPCS 27 (VA South Zone 4502). Using CORPSCON, convert existing SPCS 27 coordinates at the sheet center and corners to SPCS 83 (US Survey Foot), and compare SPCS 83-27 differences.

SPCS 83	SPCS 27		SPCS 83 - SPCS 27	
Center of Sheet	N 3,527,095.554	Y 246,200.000	dY = 3,280,895.554	
	E 11,921,022.711	X 2,438,025.000	dX = 9,482,997.711	
NW Corner	N 3,527,595.553	Y 246,700.000	dY = 3,280,895.553	
	E 11,920,522.693	X 2,437,525.000	dX = 9,482,997.693	
NE Corner	N 3,527,595.556	Y 246,700.000	dY = 3,280,895.556	
	E 11,921,522.691	X 2,438,525.000	dX = 9,482,997.691	
SE Corner	N 3,526,595.535	Y 245,700.000	dY = 3,280,895.535	
	E 11,921,522.702	X 2,438,525.000	dX = 9,482,997.702	
SW Corner	N 3,526,595.535	Y 245,700.000	dY = 3,280,895.535	
	E 11,920,522.704	X 2,437,525.000	dX = 9,482,997.704	

Since coordinate differences do not exceed 0.03 feet in either the X or Y direction, the computed SPCS 83-27 coordinate differences at the center of the sheet may be used as a fixed conversion factor to be applied to all existing SPCS 27 coordinates on this drawing.

Example 2. Assuming a 1 inch = 1,000 ft base map is prepared of the same general area, a standard drawing will cover some 30,000 feet in an east-west direction. Computing SPCS 83-27 differences along this alignment yields the following:

SPCS 83	SPCS 27		SPCS 83 - SPCS 27	
West End	N 3,527,095.554	Y 246,200.000	dY = 3,280,895.554	
	E 11,921,022.711	X 2,438,025.000	dX = 9,482,997.711	
East End	N 3,527,095.364	Y 246,200.000	dY = 3,280,895.364	
	E 11,951,022.104	X 2,468,025.000	dX = 9,482,997.104	

The conversion factor gradient across this sheet is about 0.2 ft in Y and 0.6 ft in X. Such small changes are not significant at the plot scale of 1 inch = 1,000 ft; however, for referencing basic design or construction control, applying a fixed shift across an area of this size is not recommended -- individual points should be transformed separately. If this 30,000-ft distance were a navigation project, then a fixed conversion factor computed at the center of the sheet would suffice for all bathymetric features. Caution should be exercised when converting portions of projects or military installations or projects that are adjacent to other projects that may not be converted. If the same monumented control points are used for several projects or parts of the same project, different datums for the two projects or parts thereof could lead to surveying and mapping errors, misalignment at the junctions and layout problems during construction.

d. Dual grids ticks. Depicting both NAD 27 and NAD 83 grid ticks and coordinate systems on maps and drawings should be avoided where possible. This is often confusing and can increase the chance for errors during design and construction. However, where use of dual grid ticks and coordinate systems is unavoidable, only secondary grid ticks in the margins will be permitted.

e. Field survey methods. If GPS is used to set new control points referenced to higher order control many miles from the project (e.g., CORS networks), inconsistent data may result at the project site. If the new control is near older control points that have been converted to NAD 83 using CORPSCON, two slightly different network solutions can result, even though both have NAD 83 coordinates. In order to avoid these situations, it is recommended that all project control (old and new) be tied into the same reference system--preferably the NSRS.

f. Local project datums. Local project datums that are not referenced to NAD 27 cannot be mathematically converted to NAD 83 with CORPSCON. Field surveys connecting them to other stations that are referenced to NAD 83 are required.

5-16. Horizontal Transition Plan from NAD 27 to NAD 83

a. General. Not all maps, engineering site drawings, documents, and associated products containing coordinate information will require conversion to NAD 83. To insure an orderly and timely transition to NAD 83 is achieved for the appropriate products, the following general guidelines should be followed:

(1) Initial surveys. All initial surveys should be referenced to NAD 83.

(2) Active projects. Active projects where maps, site drawings or coordinate information are provided to non-USACE users (e.g., NOAA, USCG, FEMA, and others in the public and private sector) coordinates should be converted to NAD 83 the next time the project is surveyed or maps or site drawings are updated for other reasons.

(3) Inactive projects. For inactive projects or active projects where maps, site drawings or coordinate information are not normally provided to non-USACE users, conversion to NAD 83 is optional.

(4) Datum notes. Whenever maps, site drawings or coordinate information (regardless of type) are provided to non-USACE users, it should contain a datum note, such as the following:

THE COORDINATES SHOWN ARE REFERENCED TO NAD *[27/83] AND ARE IN FEET BASED ON THE SPCS *[27/83] *[STATE, ZONE]. DIFFERENCES BETWEEN NAD 27 AND NAD 83 AT THE CENTER OF THE *[SHEET/DATASET] ARE *[dLat, dLon, dX, dY]. DATUM CONVERSION WAS PERFORMED USING THE COMPUTER PROGRAM "CORPSCON." METRIC CONVERSIONS WERE BASED ON THE *[US SURVEY FOOT = 1200/3937 METER] [INTERNATIONAL FOOT = 30.48/100 METER].

b. Levels of effort. For maps and site drawings the conversion process entails one of three levels of effort:

- (1) Conversion of coordinates of all mapped details to NAD 83, and redrawing the map,
- (2) Replace the existing map grid with a NAD 83 grid,
- (3) Simply adding a datum note.

For surveyed points, control stations, alignment, and other coordinated information, conversion must be made either through a mathematical transformation or through readjustment of survey observations.

c. Detailed instructions.

(1) Initial surveys on Civil Works projects. The project control should be established on NAD 83 relative to NGS's National Spatial Reference System (NSRS) using conventional or GPS surveying procedures. The local SPCS 83 grid should be used on all maps and site drawings. All planning and design activities should then be based on the SPCS 83 grid. This includes supplemental site plan mapping, core borings, project design and alignment, construction layout and payment surveys, and applicable boundary or property surveys. All maps and site drawings shall contain datum notes. If the local sponsor requires the use of NAD 27 for continuity with other projects that have not yet converted to NAD 83, conversion to NAD 27 could be performed using the CORPSCON transformation techniques.

(2) Active Civil Works Operations and Maintenance projects undergoing maintenance or repair. These projects should be converted to NAD 83 during the next maintenance or repair cycle in the same manner as for newly initiated civil works projects. However, if resources are not available for this level of effort, either redraw the grids or add the necessary datum notes. Plans should be made for the full conversion during a later maintenance or repair cycle when resources can be made available.

(3) Military Construction and master planning projects. All installations and master planning projects should remain on NAD 27 or the current local datum until a thoroughly coordinated effort can be arranged with the MACOM and installation. An entire installation's control network should be transformed simultaneously to avoid different datums on the same installation. The respective MACOMs are responsible for this decision. However, military operations may require NAD 83, including SPCS 83 or UTM metric grid systems. If so, these shall be performed separate from facility engineering support. A dual grid system may be required for such operational applications when there is overlap with normal facilities engineering functions. Coordinate transformations throughout an installation can be computed using the procedures described herein. Care must be taken when using transformations from NAD 27 with new control set using GPS methods from points remote from the installation. Installation boundary surveys should adhere to those outlined under real estate surveys listed below.

(4) Real Estate. Surveys, maps, and plats prepared in support of civil works and military real estate activities should conform as much as possible to state requirements. Since most states have adopted NAD 83, most new boundary and property surveys should be based on NAD 83. The local authorities should be contacted before conducting boundary and property surveys to ascertain their policies. It should be noted that several states have adopted the International Foot for their standard conversion from meters to feet. In order to avoid dual coordinates on USACE survey control points that have multiple uses, all control should be based on the US Survey Foot, including control for boundary and property surveys. In states where the International Foot is the only accepted standard for boundary and property surveys, conversion of these points to NAD 83 should be based on the International foot, while the control remains based on the US Survey foot.

(5) Regulatory functions. Surveys, maps, and site drawings prepared in support of regulatory functions should begin to be referenced to NAD 83 unless there is some compelling reason to remain on NAD 27 or locally used datum. Conversion of existing surveys, maps, and drawings to NAD 83 is not necessary. Existing surveys, maps, and drawings need only have the datum note added before distribution to non-USACE users. The requirements of local, state and other Federal permitting agencies should be ascertained before site specific conversions are undertaken. If states require conversions based on the International foot, the same procedures as described above for Real Estate surveys should be followed.

(6) Other existing projects. Other existing projects, e.g., beach nourishment, submerged offshore disposal areas, historical preservation projects, etc., need not be converted to NAD 83. However, existing surveys, maps, and drawings should have the datum note added before distribution to non-USACE users.

(7) Work for others. Existing projects for other agencies will remain on NAD 27 or the current local datum until a thoroughly coordinated effort can be arranged with the sponsoring agency. The decision to convert rests with the sponsoring agency. However, existing surveys, maps, and drawings should have the datum note added before distribution to non-USACE users. If sponsoring agencies do not indicate a preference for new projects, NAD 83 should be used. The same procedures as described above for initial surveys on Civil Works projects should be followed.

SECTION III Vertical Reference Systems

A vertical datum is the surface to which elevations or depths are referred to or referenced. There are many vertical datums used within CONUS. The surveyor should be aware of the vertical control datum being used and its practicability to meet project requirements. .

5-17. National Geodetic Vertical Datum of 1929 (NGVD 29)

NGVD 29 was established by the United States Coast and Geodetic Survey (USC&GS) 1929 General Adjustment by constraining the combined US and Canadian First Order leveling nets to conform to Mean Sea Level (MSL). It was determined at 26 long-term tidal gage stations that were spaced along the east and west coast of North American and along the Gulf of Mexico, with 21 stations in the US and 5 stations in Canada. NGVD 29 was originally named the Mean Sea Level Datum of 1929. It was known at the time that the MSL determinations at the tide gages would not define a single equipotential surface because of the variation of ocean currents, prevailing winds, barometric pressures, and other physical causes. The name of the datum was changed from the Mean Sea Level Datum to the NGVD 29 in 1973 to eliminate the reference to sea level in the title. This was a change in name only; the definition of the datum established in 1929 was not changed. Since NGVD 29 was established, it has become obvious that the geoid based upon local mean tidal observations would change with each measurement cycle. Estimating the geoid based upon the constantly changing tides does not provide a stable estimate of the shape of the geoid.

5-18. North American Vertical Datum of 1988 (NAVD 88)

The NAVD 88 datum is the product of a vertical adjustment of leveled height difference measurements made across North America. This reference system supersedes the NGVD 29 vertical reference framework. NAVD 88 was constrained by holding fixed the orthometric height of a single primary tidal benchmark at Father's Point / Rimouski, Quebec, Canada and performing a minimally constrained general adjustment of US-Canadian-Mexican leveling observations. Most Third Order benchmarks, including those of other Federal, state and local government agencies, were not included in the NAVD 88 adjustment. The vertical reference surface is therefore defined by the surface on which the gravity values are equal to the control point value. NAVD 88 elevations are published orthometric heights that represent the geometric distance from the geoid to the terrain measured along the plumb line. Orthometric height corrections were used to enforce consistency between geopotential based vertical coordinates and measured leveled differences. NAVD 88 is the most compatible vertical reference frame available to relate GPS ellipsoidal heights to orthometric heights. Note also that NGVD 29 is no longer supported by NGS; thus, USACE commands should be transitioning all older project vertical control to NAVD 88. The differences in orthometric elevations between the superseded NGVD 29 and NAVD 88 references are significant--upwards of 1.5 meters in places, as depicted in Figure 5-11 below. Therefore, it is important that these two reference systems not be confused. Given the local variations shown in Figure 5-14, there is no direct transformation between the two systems, and a site calibration/transformation must be performed as explained in subsequent sections.

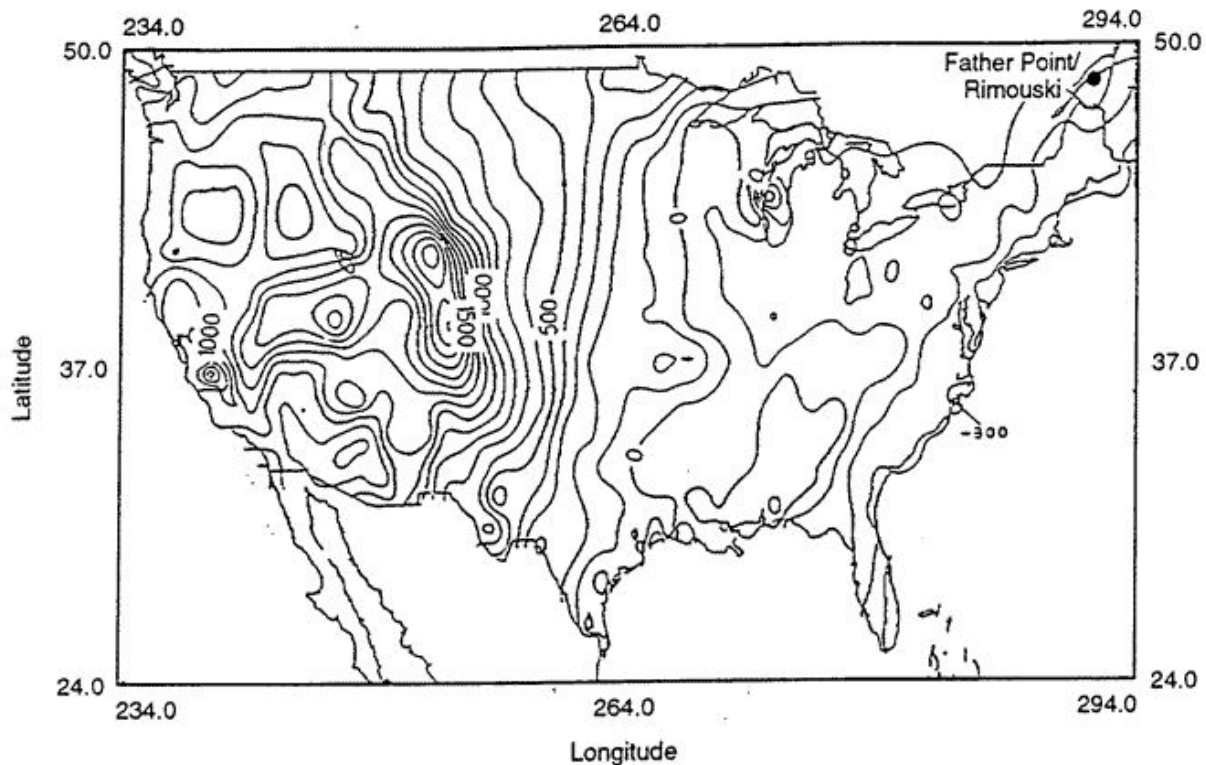

Figure 5-11. NGVD 29-NAVD 88 elevation differences in mm

The Federal Geodetic Control Subcommittee (FGCS) of the Federal Geographic Data Committee (FGDC) has affirmed that NAVD 88 shall be the official vertical reference datum for the US. The FGDC has prescribed that all surveying and mapping activities performed or financed by the Federal Government make every effort to begin an orderly transition to NAVD 88, where practicable and feasible. Further technical details on NAVD 88 are in Appendix C, “*Development and Implementation of NAVD 88.*”

5-19. Other Vertical Reference Datums and Planes

a. Mean Sea Level datums. Some vertical datums are referenced to mean sea level. Such datums typically are maintained locally or within a specific project area. The theoretical basis for these datums is local mean sea level. Local MSL is a vertical datum based on observations from one or more tidal gaging stations. NGVD 29 was based upon the assumption that local MSL at 21 tidal stations in the US and 5 tidal stations in Canada averaged 0.0 ft on NGVD 29. The value of MSL as measured over the Metonic cycle of 19 years shows that this assumption is not valid and that MSL varies from station to station.

b. Great Lake datums. Depths in the Great Lakes and connecting channels are referenced to the International Great Lakes Datum (IGLD) of 1985. IGLD 85 represents a low water datum from which navigation is maintained. A separate datum is established for each of the Great Lakes. The datum must be adjusted for slope in the connecting channels between the Great Lakes. These datums undergo periodic adjustment. For example, the IGLD 55 was adjusted in 1985 to produce IGLD 85. IGLD 85 has been directly referenced to NAVD 88 and originates at the same point as NAVD 88. Additional details are provided in Appendix C.

c. *Other vertical datums.* Other areas may maintain and employ specialized vertical datums. For instance, vertical datums maintained in Alaska, Puerto Rico, Hawaii, the Virgin Islands, Guam, and other islands and project areas. Specifications and other information for these particular vertical datums can be obtained from the particular District responsible for survey related activities in these areas, or the National Ocean Service (NOS).

d. *Tidal areas.* Tidal datums usually are defined by the range and phase of the tide and usually are referenced to a mean lower low water elevation, or MLLW. In offshore coastal areas, CONUS navigation projects are generally referenced to a MLLW datum established by NOS or the Corps from long-term gage observations. This MLLW reference plane is not a flat surface but slopes as a function of the tidal range in the area. Tidal range can increase or decrease near coastal entrances; thus the MLLW must be accurately modeled throughout the navigation project. The required grade at all points on the navigation project is dependent on tidal modeling--requiring determination of the elevation of the MLLW datum plane from a series of gage observations at each point. For further information on these and other tidal datum related terms, refer to Appendix B, "*Requirements and Procedures for Referencing Coastal Navigation Projects to Mean Lower Low Water (MLLW) Datum*" and EM 1110-2-1003 (*Hydrographic Surveying*)

e. *Inland river areas.* River datums are usually referenced to a low water reference plane (LWRP), such as the LWRP 1974 reference used in the unregulated portion of the Mississippi River. Like tidal MLLW, the low water river datum must be determined from gage/staff observations at sufficient points along the river to adequately define the surface. The spacing of these observations must be sufficient to allow linear interpolation between staff gage points. For a river like the Mississippi that drops 0.5 ft/mile, gages or benchmarks may be required at least every quarter- to half-mile in order to reference hydrographic surveys.

f. *Controlled river pools.* Between river control structures, low water pools are used to reference maintained navigation depths. Since these pools themselves may exhibit some slope, sufficient gages/benchmarks within the pools should be established to account for any minor slope.

g. *Reservoir pools.* Depths in controlled reservoirs are usually referenced to a national vertical datum (e.g., NGVD 29 or NAVD 88).

5-20. Orthometric Elevations

Orthometric elevations are those corresponding to the earth's irregular geoidal surface, as illustrated in Figure 5-12 below. Measured differences in elevation from spirit leveling are generally relative to the local geoidal surface--a spirit level bubble (or pendulum) positions the instrument normal to the direction of gravity, and thus parallel with the local slope of the geoid, which approximates mean sea level near coastal points. The orthometric height of a point is the distance from the geoid (or a related reference surface) to the point on the earth's surface, measured along the line perpendicular to every equipotential surface in between. A series of equipotential surfaces can be used to represent the gravity field. One of these surfaces, the geoid, is specified as the reference system from which orthometric heights are measured. The geoid itself is defined as an equipotential surface. Natural variations in gravity induce a smooth, continuous, curvature to the plumb line, and therefore physical equipotential surfaces which are normal to gravity do not remain geometrically parallel over a given vertical distance (the plumb line is not quite parallel to the ellipsoidal normal). Elevation differences between two points are orthometric differences, a distinction particularly important in river/channel hydraulics. Orthometric heights for the continental United States (CONUS) are generally referenced to the NGVD 29 or the updated NAVD 88. The NGVD 29 reference datum more closely approximates mean sea level--the NAVD 88 does not. Tidal reference datums (e.g., MLLW) vary geographically over short distances and must be accurately

related to NAVD 88 and/or NGVD 29 orthometric heights. GPS derived ellipsoidal heights shown in Figure 5-12 below must be converted to local orthometric elevations in order to have useful engineering and construction value--see EM 1110-1-1003 for details. This transformation is usually done by a form of "site calibration" using known orthometric elevations of fixed benchmarks and/or geoid undulation models for the project area. These transforms are further explained below.

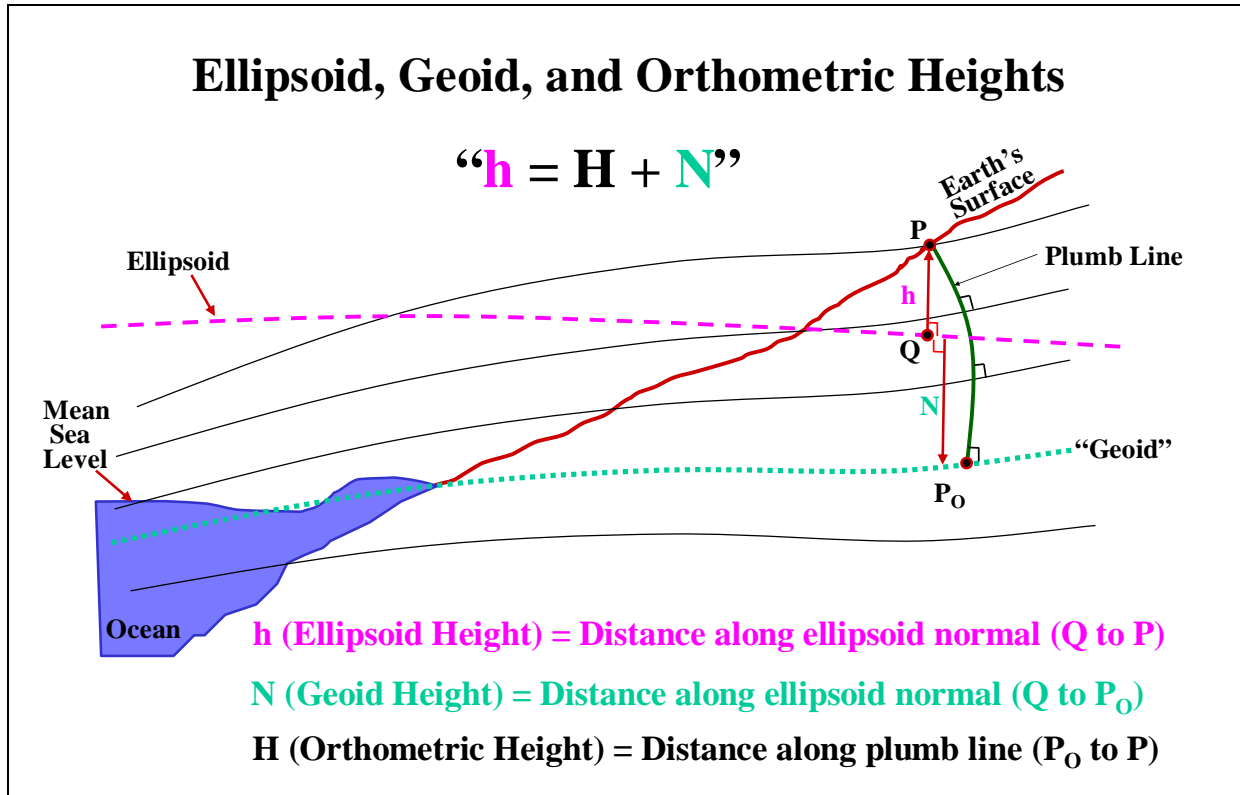

Figure 5-12. Ellipsoid, geoid, and orthometric surface definitions and relationships (NGS)

5-21. WGS 84 Ellipsoidal Heights

GPS-determined heights (or height differences) are referenced to an idealized mathematical ellipsoid which differs significantly from the geoid; thus, GPS heights are not the same as the orthometric heights needed for standard USACE projects (local engineering, construction, and hydraulic measurement functions). Accordingly, any WGS 84 referenced ellipsoidal height obtained using GPS must be transformed or calibrated to the local orthometric vertical datum. This requires adjusting and interpolating GPS-derived heights relative to fixed orthometric elevations. Over short distances--less than 1 km--elevation differences determined by GPS can usually be assumed to be orthometric differences. These elevation differences would then be of sufficient accuracy for topographic site plan mapping, such as those acquired using RTK total station methods. However, at greater distances, a site calibration with surrounding benchmarks must be performed in order to adjust RTK ellipsoidal heights down to the local vertical datum. For some surveys (e.g., offshore navigation), a predicted geoid model may be used if no other vertical control is available to calibrate the model.

5-22. Orthometric Height and WGS 84 Ellipsoidal Elevation Relationship

Geoidal heights represent the geoid-ellipsoid separation distance and are obtained by taking the difference between ellipsoidal and orthometric height values. Knowledge of the geoid height enables the evaluation of vertical positions in either the geodetic (ellipsoid based) or the orthometric height system. The relationship between a WGS 84 ellipsoidal height and an orthometric height relative to the geoid can be obtained from the following equation, and depicted graphically in Figure 5-12 above.

$$h = H + N \tag{Eq 5-2}$$

where

- h = ellipsoidal height (WGS 84)
- H = elevation (orthometric--normal to geoid)
- N = geoidal undulation above or below the WGS 84 ellipsoid

and by convention the geoid undulation " N " being a positive height above the ellipsoid.

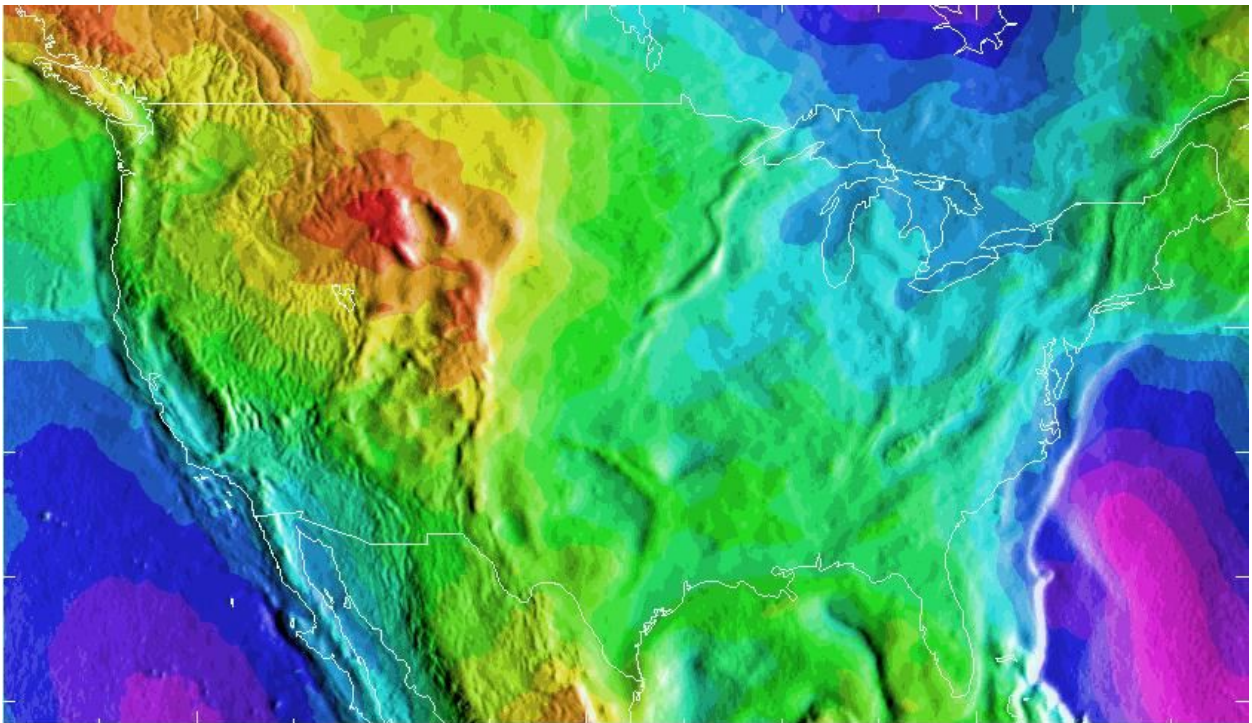

Figure 5-13. Geoid undulation model of North America--depicts geoid undulation N relative to the WGS 84 ellipsoid

5-23. Geoid Undulations and Geoid Models

Due to significant variations in the geoid, sometimes even over small distances, elevation differences obtained by GPS cannot be directly equated to orthometric (or spirit level) differences. This geoid variation is depicted as a surface model in Figure 5-13 above. Geoid modeling techniques are used to obtain the parameter " N " in the above equation from which ellipsoidal heights can be converted to orthometric elevations. These geoid models (e.g., Geoid 90, Geoid 93, Geoid 96, Geoid 99, Geoid 03, etc.) are approximations based on observations by the NGS. Each successive geoid model is more accurate. In time, these models may improve to centimeter-level accuracy. On some small project areas where the geoid stays relatively constant, elevation differences obtained by GPS can be directly used without geoid correction. Geoid models are not compatible with the superseded NGVD 29.

a. Geoid height values at stations where either only " h " or " H " is known can be obtained from geoid models which are mathematical surfaces representing the shape of the earth's gravity field. The geoid model is constructed from a truncated functional series approximation using a spherical harmonics expansion and an extensive set of globally available gravity data. The model is determined from the unique coefficients of the finite series representing the geoid surface. Its accuracy depends on the coverage and accuracy of the gravity measurements used as boundary conditions. Former geoid models produced for general use limit absolute accuracies for geoid heights to no less than 1 meter. More recent geoid models have shown a significant increase in absolute accuracy for geoid heights to a few centimeters.

b. In practice the shape of the geoid surface is estimated globally as a function of horizontal coordinates referenced to a common geocentric position. Specific geoid height values are extracted from the model surface at the node points of a regular grid (e.g., a 2-minute x 2-minute grid spacing). Biquadratic interpolation procedures can be used within a grid cell boundary to approximate the geoid height at a given geodetic latitude and longitude. For example, the NGS GEOID 96 model for the United States indicates geoid heights (N) range from a low of (-) 51.6 meters in the Atlantic to a high of -7.2 meters in the Rocky Mountains. For more information on geoid modeling, see the references in Appendix A or the National Geodetic Survey web site.

c. GPS surveys can be designed to provide elevations of points on any local vertical datum. This requires connecting to a sufficient number of existing orthometric benchmarks from which the elevations of unknown points can be "best-fit" or "site calibrated" by some adjustment method--usually a least squares minimization. This is essentially an interpolation process and assumes linearity in the geoid slope between two established benchmarks. If the geoid variation is not linear--as is typically the case--then the adjusted (interpolated) elevation of an intermediate point will be in error. Depending on the station spacing, location, local geoid undulations, and numerous other factors, the resultant interpolated/adjusted elevation accuracy is usually not suitable for accurate (i.e., ± 0.01 ft) construction surveying purposes; however, GPS-derived elevations may be adequate for small-scale topographic mapping control and hydrographic surveying applications where ± 0.1 ft accuracy is sufficient.

5-24. Using GPS to Densify Orthometric Elevations

DGPS observation sessions produce 3-D geodetic coordinate differences that establish the baseline between two given stations. The expected accuracy of ellipsoidal height difference measurements is based on several factors, such as GPS receiver manufacture type, observation session duration, and the measured baseline distance, but it does not depend greatly on prior knowledge of the absolute vertical position of either occupied station. Dual frequency, carrier phase measurement based GPS surveys are usually able to produce 3-D relative positioning accuracies under 30 mm at the 95% confidence level over baseline distances less than 20 km, depending on the type of GPS surveying method used. This situation

exists mainly because GPS range biases are physically well correlated over relatively short distances and tend to cancel out as a result of forming double differences for carrier phase data processing. In contrast, GPS absolute code positioning accuracy will contain the full effects of any GPS range measurement errors. Geoidal height differences describe the change in vertical position of the geoid with respect to the ellipsoid between two stations. These relative geoidal heights can be more accurate than the modeled absolute separation values within extended areas because the relative geoidal height accuracy is based on the continuous surface characteristics of the geoid model, where only small deviations between closely spaced points would be expected. The regional trend or slope of the geoid at a given point will not be highly sensitive to local gravity anomalies especially in non-mountainous areas. Differential GPS can accurately measure ellipsoidal height differences from GPS satellites. GPS surveys output vertical positions in geodetic coordinates defined with respect to the WGS 84 reference ellipsoid. The ellipsoidal height value at a given point is based on the distance measured along the normal vector from the surface of the reference ellipsoid to the unknown point. The practical accuracy of WGS 84 as a vertical reference frame for collecting elevation data depends on the actual ellipsoidal height values assigned to benchmarks or other physically defined control points.

5-25. Vertical Datum Transformations

Appendix C (*Development and Implementation of NAVD 88*) contains a detailed discussion on the development and implementation of NAVD 88, and the rationale for converting projects from NGVD 29 to this updated vertical datum. There are several reasons for USACE commands to convert authorized and future projects to NAVD 88--these are summarized from Appendix C.

- Differential leveling surveys will close better.
- NAVD 88 height values are available in convenient form from the NGS database.
- Federal surveying and mapping agencies will stop publishing on NGVD 29.
- NAVD 88 is recommended by ACSM and FGCS.
- Surveys performed for the Federal government require use of NAVD 88.
- NAVD 88 provides a reference to estimate GPS derived orthometric heights.

The last bullet above is a primary reason for transforming project control to NAVD 88. The conversion process entails one of two levels of effort that are covered in detail in Appendix C:

- (1) Conversion of all elevations to NAVD 88 by readjustment or releveling.
- (2) Adding a datum note based on an approximate conversion (VERTCON).

a. VERTCON. VERTCON is a software program developed by NGS that converts elevation data from NGVD 29 to NAVD 88. Although the VERTCON software has been fully incorporated into the software application package CORPSCON, it will be referred to below as a separate program. VERTCON uses benchmark heights to model the shift between NGVD 29 and NAVD 88 that is applicable to a given area. In general, it is only sufficiently accurate to meet small-scale mapping requirements. VERTCON should not be used for converting benchmark elevations used for site plan design or construction applications. Users input the latitude and longitude for a point and the vertical datum shift between NGVD 29 and NAVD 88 is reported. The root-mean-square (RMS) error of NGVD

29 to NAVD 88 conversion, when compared to the stations used to create the conversion model, is ± 1 cm; with an estimated maximum error of ± 2.5 cm. Depending on network design and terrain relief, larger differences (e.g., 5 to 50 cm) may occur the further a benchmark is located from the control points used to establish the model coefficients. For this reason, VERTCON should only be used for approximate conversions where these potential errors are not critical.

b. Datum note. Whenever maps, site drawings, or spatial elevation data are provided to non-USACE users, they should contain a datum note that provides, at minimum, the following information:

The elevations shown are referenced to the *[NGVD 29] [NAVD 88] and are in *[feet] [meters]. Differences between NGVD 29 and NAVD 88 at the center of the project sheet/data set are shown on the diagram below. Datum conversion was performed using the *[program VERTCON] [direct leveling connections with published NGS benchmarks] [other]. Metric conversions are based on *[US Survey Foot = 1200/3937 meters] [International Survey Foot = 0.3048 meters].

5-26. Vertical Transition Plan from NGVD 29 to NAVD 88

a. General. A change in the vertical datum on a project will affect USACE engineering, construction, planning, and surveying activities. The cost of conversion could be substantial at the onset. There is a potential for errors in conversions inadvertently occurring. The effects of the vertical datum change can be minimized if the change is gradually applied over time; being applied to future projects and efforts, rather than concentrated on changing already published products. In order to insure an orderly and timely transition to NAVD 88 is achieved for the appropriate products, the following general guidelines should be followed.

b. Conversion criteria. Maps, engineering site drawings, documents, and associated spatial data products containing elevation data may require conversion to NAVD 88. Specific requirements for conversion will, in large part, be based on local usage--e.g., that of the local sponsor, installation, etc. Where applicable and appropriate, this conversion should be recommended to local interests.

c. Newly authorized construction projects. Generally, initial surveys of newly authorized projects should be referenced to NAVD 88. In addition to design/construction, this would include wide-area master plan mapping work. The project control should be referenced to NAVD 88 using conventional or GPS surveying techniques. All planning and design activities should be based upon NAVD 88. All maps and site drawings shall contain datum notes as described below. If the sponsor/installation requires the use of NGVD 29 or some other local vertical reference datum for continuity, the relationship between NGVD 29 and NAVD 88 shall be clearly noted on all maps, engineering site drawings, documents, and associated products.

d. Active projects. On active projects where maps, site drawings, or elevation data are provided to non-USACE users, the conversion to NAVD 88 should be performed. This conversion to NAVD 88 may be performed the next time the project is surveyed or when the maps/site drawings are updated for other reasons. Civil works projects may be converted to NAVD 88 during the next maintenance or repair cycle in the same manner as for newly initiated civil works projects. However, if resources are not available for this level of effort, redraw the maps or drawings and add the necessary datum note. Plans should be made for the full conversion during a later maintenance or repair cycle when resources can be made available. Military installations should remain on NGVD 29 or the local vertical datum until a thoroughly coordinated effort can be arranged with the MACOM and installation. An entire installation's control network should be transformed simultaneously to avoid different datums on the same installation. MACOMs should be encouraged to convert to NAVD 88. However, the respective MACOMs are responsible for this decision.

e. Inactive projects. For inactive projects or active projects where maps, site drawings, or elevation data are not normally provided to non-USACE users, conversion to NAVD 88 is optional.

f. Work for others. Projects for other agencies will remain on NGVD 29 or the current local vertical datum until a thoroughly coordinated effort can be arranged with the sponsoring agency. Other agencies should be encouraged to convert their projects to NAVD 88, although the decision to convert rests with the sponsoring agency. However, surveys, maps, and drawings should have the datum note described below added before distribution to non-USACE users. If sponsoring agencies do not indicate a preference for new projects, NAVD 88 should be used.

g. Miscellaneous projects. Other projects referenced to strictly local datum, such as, beach nourishment, submerged offshore disposal areas, historical preservation projects, etc., need not necessarily be converted to NAVD 88. However, it is recommended that surveys, maps and drawings have a clear datum reference note added before distribution to non-USACE users.

h. Real Estate. Surveys, maps, and plats prepared in support of civil works and military real estate activities should conform as much as possible to state requirements. Many states are expected to adopt NAVD 88 (by statute) as an official vertical reference datum. This likewise will entail a transition to NAVD 88 in those states. State and local authorities should therefore be contacted to ascertain their current policies. Note that several states have adopted the International Foot for their standard conversion from meters to feet. In order to avoid dual elevations on USACE survey control points that have multiple uses, it is recommended that published elevations be based on the US Survey Foot. In states where the International Foot is the only accepted standard for boundary and property surveys, conversion of these elevations to NAVD 88 should be based on the International Foot while the control remains based on the US Survey Foot.

5-27. Vertical Control in Areas Subjected to Subsidence or Sea Level Rise

Published elevations relative to the vertical datums in high subsidence areas must be used with caution. This is due to the uneven temporal and spatial movement of the land. Thus, any geodetic or terrestrial-based elevation is not constant and must be periodically observed and adjusted for local subsidence. Likewise, hydraulic or sea level based reference datums are subject to variations due to subsidence and sea level rise at each gage site. Sea level datums also have time varying astronomical components making their reference definition more complex than terrestrial based datums. Hydraulic low water reference datums used to define navigation and flood protection elevations on the Mississippi River may also be subject to subsidence and other long-term variations, and thus these datums are spatially and temporally variable.

Subsidence is the lowering or sinking of Earth's surface, often quantified relative to non-sinking portions of the Earth's crust. It is especially pronounced in portions of California, Texas, and Louisiana. In Southern Louisiana, subsidence is occurring at a rate of up to 0.1 foot every three years in some areas. There are many potential factors that contribute to subsidence, such as the geologic composition of the area and withdrawal of ground water and oil. The rate of subsidence is not always constant and can vary from epoch to epoch (survey to survey) due to many factors, such as compaction, removal of subsurface fluids, and geologic events. Therefore, one cannot predict future subsidence with any degree of accuracy. Table 1 below illustrates the large variability in subsidence rates of change occurring over a relatively small region in Louisiana. These rates were determined from periodic First-Order, Class II leveling surveys by NOAA.

Table 1 Apparent Benchmark Movement Rates	
Benchmark Designation	Rates of Movement in Millimeters per year
A 148 (AU0429)	-11.01
PIKE RESET (BH1164)	-6.99
231 LAGS (BH1073)	-16.08
A 92 (BH1136)	-7.39

Subsidence can be measured and/or periodically monitored using either conventional leveling procedures or GPS techniques contained in NOAA 1997 (Guidelines for Establishing GPS-Derived Ellipsoid Heights (Standards: 2 cm and 5 cm)). Determining subsidence rates requires long-term observations and considerable analysis. As an example, Figure 5-14 below contains a map showing the estimated amount of subsidence along the route between New Orleans and Venice, LA. The leveling for this line was performed by NOAA in 1984 and adjusted to the NGVD 29 datum at that time. In 1991, NGS adjusted the entire CONUS to the NGVD 29 datum in preparation for the NAVD 88 adjustment. In Southern Louisiana, an extensive “GPS Derived Height” network was completed establishing new heights (elevations) for 85 benchmarks in Southern Louisiana. This adjustment, known as NAVD 88 (2004.65), held control outside of the subsidence area to establish new NAVD88 adjusted heights for the 85 benchmarks. Because the 1991 NAVD 88 adjustment held control outside of the area, as did the NAVD 88 (2004.65) adjustment, the change in the heights reflects the apparent movement of the marks between the observation periods. In order to determine the amount of subsidence from the time the original leveling was done, it is necessary to determine the amount of movement between the original adjustment and the 1991 national readjustment of the NGVD 29 and then the amount of movement between the original NAVD 88 adjustment and the NAVD 88 (2004.65) adjustment.

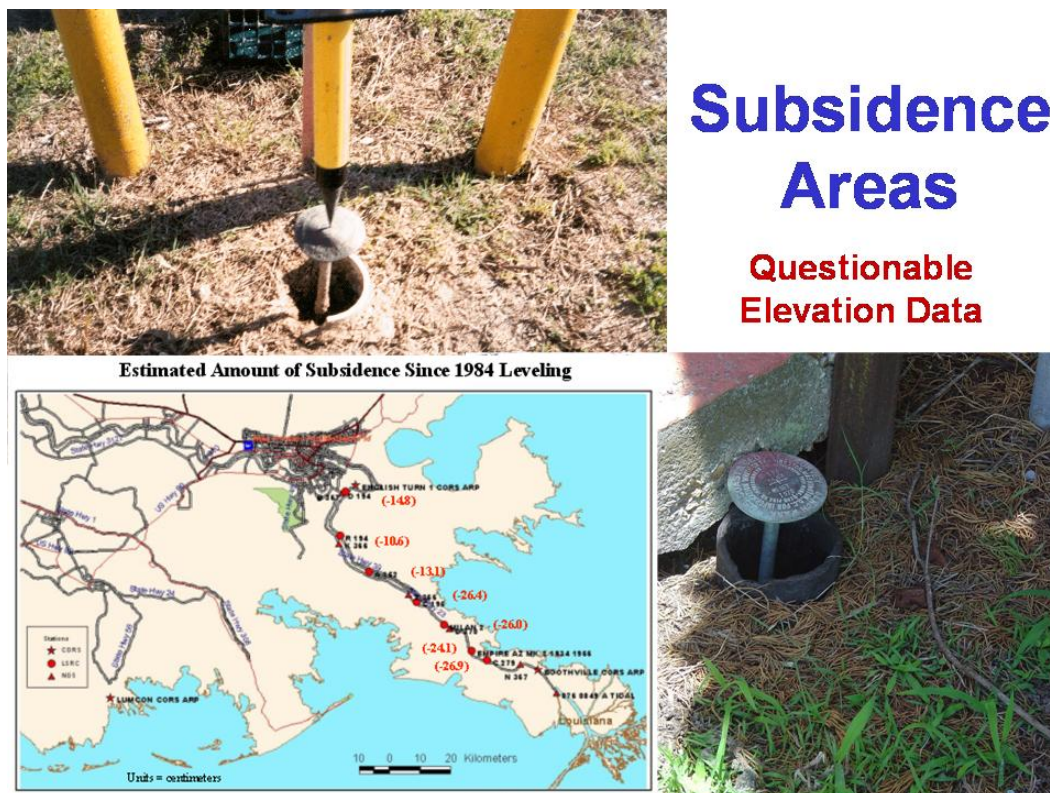

Figure 5-14. Estimated subsidence (in centimeters) in the New Orleans to Venice region. Photos depict relative ground subsidence of benchmarks attached to deep driven rods.

Monitoring subsidence or sea level changes on flood control, hurricane protection, or coastal (tidal) navigation projects requires continuous leveling or GPS surveys between water level recording gages and fixed benchmarks. Vertical datums (NAVD 88 and tidal lower low water datums) must be periodically updated to reflect changes due to subsidence or sea level rise.

5-28. Mandatory Standards

Spatial data collected for projects shall be referenced to the updated NAD 83 and NAVD 88 reference datums established by the National Oceanic and Atmospheric Administration (NOAA). Navigation projects referenced to tidal datums shall be updated to the latest tidal epoch (currently 1983-2001) in accordance with the statutory requirements in Section 224 of the Water Resources Development Act of 1992 (see Appendix B). Flood control or hurricane protection structure elevations shall be referred to the hydrodynamic surface model datum used in the design analysis.

Chapter 6 Planning and Conducting Control and Topographic Surveys

6-1. Purpose

This chapter provides general guidance on planning control and topographic surveys. Requirements and methods for extending nationwide control networks into a facility project site are described. Sources of geodetic control data are described. Guidance is also provided on selecting map scales, feature location tolerances, and contour intervals for typical engineering and construction projects. Actual procedural examples of projects performed by various Districts are found in the appendices to this manual.

6-2. Project Requirements from Using Agency

Topographic survey requests originate from the using agency. The requestor might be an internal District office division, an outside Army installation, or another Federal or State agency. Often these requests are general in nature, and often accompanied with a request for a cost estimate to perform the survey. In many cases, the survey details, site conditions, scope, and accuracy requirements are not specified; or, more often than not, the actual work required far exceeds the given budgeted amount. Often, in such cases, the surveyor must meet with the requesting District element or outside agency and modify the accuracy and scope in order to stay within budget. Such budgetary driven compromises do not always result in an optimum survey in the user's estimation; however, the burden is often placed on the surveyor to design a survey accuracy and density that will best satisfy the design/construction requirements that the requesting entity desires. It is rare that the requesting user ever obtains the detail required for the project. Likewise, it is equally rare that the surveyor is able to perform the quality of survey he feels is necessary to adequately define the project conditions. In many cases, an advance site visit may be needed in order to assess the actual conditions and provide a reliable budget estimate (time and cost) to the requesting agency.



Figure 6-1. An advance site visit would be essential in planning for conditions such as this (Portland District)

a. Sample topographic survey request. The following excerpt is taken from a site plan mapping Scope of Work in Pittsburgh District, for a survey of a tract of land adjacent to Hannibal Lock and Dam on the Ohio River. The purpose of the survey was to develop site plans for construction of new facilities on a parcel

adjacent to the Hannibal Lock. The originating agency's request may not have been as detailed as this version sent to an AE contractor--it may have only requested a topographic site plan survey without any detailed map scale, accuracy, or utility requirements.

General Surveying and Mapping Requirements.

(1) General site plan feature and topographic detail mapping compiled at a target scale of 1"= 50 ft, 1 ft contour interval for that area annotated on furnished exhibit. Collect all existing pertinent features, drainage characteristics, drainage structures, channels, inlets and outlets, etc. Collect all surface utility data and conduct a thorough search for evidence of subsurface utilities. An underground gas line runs through a portion of the site. Gas line markers are visible.

(2) Set control monumentation as required to adequately control construction layout. Monumentation shall be set in an area outside the construction limits so as not to be disturbed during construction phases. Existing control monumentation within the vicinity may be used in lieu of setting new monumentation. All control monumentation, set or found, shall be adequately described and referenced in a standard fieldbook.

(3) Based on information established by record and by field survey, establish and delineate on the ground, with capped re-bars and witness posts, that portion of the Ohio DOT right-of-way bounding Tract 113; commencing at the edge of the right bank of the Ohio River, thence continuing along Tract 113 and Ohio Route 7. This is a critical element that will need to be properly delineated on the ground and properly annotated on the map to ensure the site is contained within COE property. At a minimum, this portion of the field work shall be performed under the on-site direction of a Professional Land Surveyor duly registered in the State of Ohio.

The above scope effectively describes the requirements of the survey. It does not specify all survey details that could be listed. For instance, it does not state what topographic elevation density is required on ground shot points. These types of details are usually left to the field surveyor to develop--presuming he knows the purpose of the site plan mapping project and is familiar with subsequent design and construction requirements. It is therefore critical that the field survey crew be made knowledgeable of the ultimate purpose of a project so that they can locate critical features which may impact on future construction.

b. Checklist format. An alternate method of describing the survey requirements is a checklist form. The following checklist in Figure 6-2 below is used by FEMA and notes critical requirements that a user/requestor must specify.

Surface Description (choose one)		Reflective surface (if using LIDAR)	
<input type="checkbox"/> Bare-earth surface (FEMA default)	<input type="checkbox"/> Top surface (e.g., treetops/rooftops)	<input type="checkbox"/> Bathymetric surface	<input type="checkbox"/> First <input type="checkbox"/> Last (FEMA default) <input type="checkbox"/> All <input type="checkbox"/> LIDAR intensity returns <input type="checkbox"/> Other simultaneous imagery
Vertical Accuracy (choose one)			
<input type="checkbox"/> 1' contour equiv. (Accuracy _z = 0.6 ft.)	<input type="checkbox"/> 2' contour equiv. (Accuracy _z = 1.2 ft.)	<input type="checkbox"/> 4' contour equiv. (Accuracy _z = 2.4 ft.)	<input type="checkbox"/> 5' contour equiv. (Accuracy _z = 3.0 ft.) <input type="checkbox"/> Other: Accuracy _z = ___ ft.
Vertical accuracy at the 95% confidence level (Accuracy _z) = RMSE _z x 1.9600 with normal distribution			
Horizontal Accuracy (choose one)			
<input type="checkbox"/> 1" = 500' equiv. (Accuracy _r = 11' or 3.35 m)	<input type="checkbox"/> 1" = 1000' equiv. (Accuracy _r = 22' or 6.7 m)	<input type="checkbox"/> RMSE _r = 1 m	<input type="checkbox"/> RMSE _r = _____
Horizontal accuracy at the 95% confidence level (Accuracy _r) = RMSE _r x 1.7308			
Data Model (choose one or more)			
<input type="checkbox"/> Contours	<input type="checkbox"/> Cross sections	<input type="checkbox"/> Mass points	<input type="checkbox"/> Breaklines
<input type="checkbox"/> TIN (average point spacing = ___ meters) *	<input type="checkbox"/> DEM (post spacing = ___ meters)		
* FEMA's standard DEM post spacing is 5-meters when mass points are supplemented with breaklines for hydraulic modeling. The TIN point spacing is typically smaller than the DEM post spacing to allow a denser network of irregularly-spaced points for interpolation of the uniformly-spaced DEM.			
Horizontal Datum (choose one)		Vertical Datum (choose one)	
<input type="checkbox"/> NAD 27	<input type="checkbox"/> NAD 83 (default)	<input type="checkbox"/> NGVD 29	<input type="checkbox"/> NAVD 88 (default)
Coordinate System (choose one)			
<input type="checkbox"/> UTM	<input type="checkbox"/> State Plane	<input type="checkbox"/> Geographic	
Units Note: For feet and meters, vertical (V) units may differ from horizontal (H) units			
<input type="checkbox"/> Feet to ___ decimal places	<input type="checkbox"/> Meters to ___ decimal places	<input type="checkbox"/> V	<input type="checkbox"/> H
<input type="checkbox"/> Decimal degrees to ___ decimal places	<input type="checkbox"/> DDDMMSS to ___ decimal places	<input type="checkbox"/> V	<input type="checkbox"/> H
Feet are assumed to be U.S. Survey Feet unless specified to the contrary			
Data Format (choose one or more)			
<u>Digital contour lines and breaklines</u>		<u>Mass points and TINs</u>	<u>DEMs</u>
<input type="checkbox"/> .DGN	<input type="checkbox"/> .DO (DLG Optional)	<input type="checkbox"/> ASCII x/y/z	<input type="checkbox"/> ASCII x/y/z
<input type="checkbox"/> .DWG	<input type="checkbox"/> .DXF	<input type="checkbox"/> ASCII with attribute data	<input type="checkbox"/> .BIL
<input type="checkbox"/> .E00	<input type="checkbox"/> .MIF/.MID	<input type="checkbox"/> BIN	<input type="checkbox"/> .BIP
<input type="checkbox"/> .SHP	<input type="checkbox"/> SDTS	<input type="checkbox"/> TIN Arc/Info Export File	<input type="checkbox"/> .BSQ
<input type="checkbox"/> TAB	<input type="checkbox"/> Other _____	<input type="checkbox"/> Other _____	<input type="checkbox"/> .DEM (USGS standard)
			<input type="checkbox"/> ESRI Float Grid
			<input type="checkbox"/> ESRI Integer Grid
			<input type="checkbox"/> GeoTiff
			<input type="checkbox"/> .RLE
			<input type="checkbox"/> Other _____
<u>File size or Tile size</u> (choose one)			
<input type="checkbox"/> File size ___ MB or 1 GB (max)			
<input type="checkbox"/> Tile size ___ x ___ (specify feet or meters)			
<input type="checkbox"/> Other tile size: _____			
<input type="checkbox"/> Buffer size: _____			
Other Quality Factors (optional, explain on separate page)			
<input type="checkbox"/> Cleanness from artifacts			
<input type="checkbox"/> Limits on size/location of void areas where there are no elevation data shown			
<input type="checkbox"/> How elevations are to be shown for void areas			
<input type="checkbox"/> Hydro-enforcement Bridges/culverts removed? <input type="checkbox"/> Yes <input type="checkbox"/> No			
<input type="checkbox"/> Other requirements			

Figure 6-2. Digital Topographic Data Requirements Checklist (FEMA)

6-3. Topographic Survey Planning Checklist

Upon receipt of a user's request for a topographic survey, as part of the planning process it is best to logically resolve many of the variables associated with a proposed site. The following planning checklist may be used as a general outline for that process. This checklist may also be useful in reviewing a topographic survey request with the end user. The remainder of the sections in this chapter will address some of these items. (This checklist is taken from the Corps PROSPECT Survey III course).

PROJECT PLANNING OBJECTIVE

- Identify considerations for planning and producing a survey.
- Identify issues to be addressed when requesting or discussing proposed work.

END-USE OF MAP OR DATA

- How will the data or map be used?
- Site planning
- Construction plans and specs
- Management
- GIS
- Will you count each tree, species, size?
- Plot boundary
- Compute areas

PROJECT PLANNING

- Thoroughly read request from user. (Request may be different than verbal agreement)
- What is the purpose of the survey?
- What did the site look like a year ago? What will it look like in one year?

SITE CONSIDERATIONS

- Has the requestor walked the site recently?
- (Not a drive-by performed 2 years ago.) Have you personally walked the site this season?
- Safety hazards to consider:
- Steep slopes
- Busy roads
- Flagger, road signs
- High speed railroad
- switching railroad
- Berries
- Poison oak, poison ivy, nettles
- Tide
- Weather patterns
- Local mentality

DELIVERABLE FORMAT

- Assume CADD environment
- Does file or map have to match existing data?
- What software will be used to view data?
- Engineering software for manipulation.
- Will a variety of output files be required?

COORDINATE SYSTEM

- Horizontal
- State plane
- State plane on what zone
- True state plane, or at ground surface
- Local
- Military coordinate system
- Recommend something that can be recovered. Perpetual coordinate system usually better.

STATIONING

- Stationing is a disjointed coordinate system where one axis is the STATION and the other is OFFSET, and the STATION axis rotates at every PI.
- Distances are usually ground distances.
- (State plane coordinates might have to be adjusted.)
- Great for linear surveys such as roads, railroads and levees.

VERTICAL COORDINATE SYSTEM

- NAVD 88 (specify adjustment date)
- MSL or NGVD 29 or NGVD 29 (XX)
- 1912 Adjustment
- MLLW
- City or Local
- Base
- Recommend a perpetual vertical system and conversion to datum used.

UNITS OF MEASURE

- Foot
- U.S. Survey Foot
- International Survey Foot
- Meter
- River mile, nautical mile
- Ground distances
- Grid distances

FILE TYPE

- .DGN
- .DWG
- .SHP
- ASCII
- .DXF
- .COT
- .TIF
- .WTIF

FILE SIZE

- Some files are just too large for PC.
- Match into existing or planning new software or computer.
- Does file size equate to sheet size?
- Are sheets necessary?

EXISTING CONTROL

- Decide what BM to hold ... 2 or more.
- Decide what horizontal to hold.
- Have these monuments been re-set?
- Always check between 2 or more existing monuments.
- Update reference ties.
- Protect during construction or relocate.

CONTROL MONUMENTS

- Set or reference permanent control
- The Same Control should be used for:
 - Project boundary recovered or set
 - Map for design
 - Plans and specs
 - Construction
 - As-Builts
 - Operation of facility as necessary
 - Project boundary should be recovered or re-set.
- Construction as per EM 1110-1-1002
- Digging permit?
- Rebar below frost line
- Stamped or capped
- Reference ties
- Reference closest boundary
- Drive-to/To-reach

- Set in protected place and set witness post

CONTROL SURVEY

- Different procedure than mapping
- Whatever it takes to meet (EM 1110-1-1004, Chapter 3).
- Typically 2 sets of angles and differential levels
- Qualify monument coordinates with a level of accuracy.
- Archive

CONTROL DIAGRAM

- Original Monuments
- (Origination of horizontal and vertical)
- Monuments set (type and designation)
- Grid coordinates
- Coordinate System
- Ground Distance/Grid Distance/Combination Factor and Grid Factor, etc.
- Reference ties

CONTROL DIAGRAM Build control diagram for:

- Mapping
- Design
- Construction plans and specs
- Archive

DELIVERABLES

- X-section plots
- Topographic map
- Digital Terrain Model
- Ink on mylar
- Paper check plots
- Color
- Black/White
- Digital files only
- Digital file specifications/format
- Levels
- Font size
- Line weights
- Global origin
- Sheet size
- Title block format
- Seed files in relevant coord. Sys/units
- Boundary plat
- File with the county
- Metadata
- Field-book
- Computation files
- Daily reports

DELIVERABLES (CONTD)

- Project Surveyor's Report (pertinent data, relevant comments by locals)
- County reports
- Digital media type (CD, DVD, tape)

OTHER CONSIDERATIONS

- Manhole (MH) work
- Size, type of each pipe flowing into MH
- Direction of flow
- Invert and rim elevation of MH
- Confined space precautions
- Only survey what you can see.
- If locates, then call out as such.
- Bridge detail
- Standard bridge sketch
- Structural detail
- Cross-section upstream and downstream
- Profile across bridge deck + 300 ft
- Low steel elevation
- Orientation to flow
- Drill holes
- Locate before drilling. (Stake for digging permit.)
- Survey after drilling. (Provide coordinate and elevation on perpetual coordinate system.)
- Piezometers
- Where do you want the elevation?
- Are they locked? Have they been located or read recently?
- Photographs of site
- Keep a logical record.
- Helpful for office when mapping.
- Show nearest utility hook-ups.
- Water
- Fire Hydrants
- Power
- Sanitary, storm etc.
- Keys
- Do we need any keys for access?
- Right of entry
- Knock on the door first
- Tree/brush clearing permits
- ROE in hand

SECURITY

- Notify installation/project office in advance (need POC)
- Name, purpose, duration
- Restricted area
- Security escort required?

- Security briefing
- E-mail
- Clothing requirement, safety clothing
- Radio contact, pager

SPECIAL CONDITIONS Survey or map during:

- Low pool
- Maximum pool
- Winter
- After or before Leaf Drop
- Conform to base or project operations.
- Base operations
- Flight schedule
- Operation schedule (spillway at dam)
- Low tide, high tide
- Not during:
 - Duck hunting season, deer hunting season
 - Calving or nesting season
 - Fish migration

SCHEDULE

- Is this time critical?
- Could we save money by waiting?
- Produce field-work now, and office later.
- Will work be contracted?
- How long to advertise, select, negotiate?
- Fiscal year (dated money)

OPTIONS TO COMPLETE WORK

- In-House
- IDC
- Credit card
- Neighboring districts
- Other engineering contracts in the district
- Other agencies

FUNDING

- Seed money to provide intelligent estimate
- Is proposed work probable?
- What kind of estimate is required?
- Format of estimate
- Cover your estimate
- Clearly state all assumptions
- Provide proposed Schedule of Obligation and Expenditure, if contracted.

PROJECT PLANNING, OFFICE

- Research
- Control
- In-house
- State
- County
- Municipality or Military Installation
- Land corners
- Previous work in area

SAFETY ISSUES

- Weather
- Gunnery
- Operations
- Tides
- Bugs
- Mud, Sand
- UNEXO
- HTRW Site Safety Plan

EQUIPMENT

- Radios
- Batteries
- Cables
- Chargers
- Place to charge
- Water jug
- First Aid/CPR
- Metal detector
- Chain saw
- Drill
- Waders or hip boots
- Work vest
- Long rod

- Steel tape
- Pocket tape
- Total station
- Reflectorless
- Robotic
- Data collection
- Need to download daily.
- Computer with software and place
- Level
- Prism pole
- Triple prism
- Lead line
- GPS
- Is site GPS friendly?

VEHICLES

- 4 x 4
- ATV & trailer
- Boat
- Skiff
- Work boat
- Fisherman's tube
- Parking at project or secured at hotel

MATERIALS

- Hubs/Stakes
- Lath
- Flagging
- Paint
- Nails
- Monuments
- Rebar

6-4. Rights-of-Entry

When entering property to conduct a survey, rights of the property owner will be respected. The following paragraphs outline some minimum guidelines that should be followed.

a. Permission. Whenever necessary, permission to enter a military installation and other private property may be acquired by the District prior to entering such property. While on the military installation, members of the survey crew will adhere to all of the stipulations (e.g., rules, regulations, directives, verbal guidance, etc.) set forth by the Installation Commander or his designated representative. The same basic guidelines are applicable when the right to enter private property is given.

b. Protection of property. Government and private property shall be protected at all times. Every effort should be made not to damage or cut trees, shrubs, plants, etc. on the property. If line cutting or other modifications must be done, the Installation Commander, or in the case of private property, the private property owner, is the only person who can grant permission to do so. It shall be standard practice that property entered shall be returned to its condition prior to entry once the survey is completed. Gates

and other structures should be left in the position in which they were found prior to entry. If a gate is closed, do not leave it open for any long period of time. Return all borrowed property (e.g., keys, maps, etc.) as instructed by the property owner or designated representative.

c. Monuments. Survey points should be placed in such a way as to not obstruct the operations of an installation or the property owners, or be offensive to their view. Monuments set as a result of the survey should be set below ground level to prevent damage by or to any equipment or vehicles; especially grass cutting tractors. Extra care must be taken when setting a survey point at or near airports. Any temporary marks set on military installations or private property will be removed as soon as possible after the survey work is completed, or at the request of the Installation Commander, property owner, and/or designated representative. Permission should be obtained before painting permanent aerial mapping targets on paved surfaces.

6-5. Sources of Existing Geospatial/Survey Data

When a request for a survey of a given project site is received, the first effort should be to research the files to ascertain if a survey of the same site has already been performed. Policies and procedures for performing searches of geospatial clearinghouse databases are prescribed in EM 1110-1-2909 (*Geospatial Data and Systems*). However, given the highly detailed scale of topographic surveys, and the need for current conditions, it is highly improbable that an archived survey of sufficient detail can be found at these geospatial data shopping sites. Regardless, NSRS control will still be needed to reference the topographic mapping. A variety of databases can be accessed to obtain horizontal and vertical control from various local, state, and federal agencies. One or more of the following sources of existing geospatial data may need to be researched before performing a topographic survey. These files may be located in the District Office, the installation or base, county clerk's office, or a local public works/utility company.

- Installation As-built drawing files. The requesting installation may have detailed hard copy or digital files of topographic surveys, utility drawings, or real estate tract maps.
- District Office files. Archived drawing files for the project site.
- Aerial photo archives.
- Utility drawings. Electric, sanitary, storm, cable, telephone, fiber optic, etc. (Figure 6-3).
- Recorded plats and related real property surveys. Consult local county courthouse, District Real Estate Division files, local surveyor's archival files, etc.
- USGS topographic quadrangle maps. USGS quadrangle maps may be used for general location references. Excerpts of these maps can be downloaded at sites such as www.topozone.com. General small-scale orthophoto imagery can also be downloaded from a number of web sites, if this imagery is needed for a background to design plans drawings and specifications.
- NGS control. Published National Geodetic Survey control can be downloaded at www.ngs.noaa.gov. This site allows simple search options for all NSRS control points in the region of the project.
- State, county, city, and regional agency control. Some states and regional/local agencies maintain web sites for searching control in their areas.

- District control. Corps control on a project or Army installation may be available in archived files.

The FGDC National Geospatial Data Clearinghouse is a potential source for imagery data within or surrounding a project site. The Geospatial Data Clearinghouse is a collection of over 250 spatial data servers that have digital geographic data primarily for use in Geographic Information Systems (GIS), image processing systems, and other modeling software. Generally, at this time the data is of small-scale resolution, which means there are few uses for large-scale topographic mapping. These data collections can be searched through a single interface based on their descriptions, or "metadata." The Clearinghouse can be reached through a link on the FGDC web site: <http://www.fgdc.gov>.

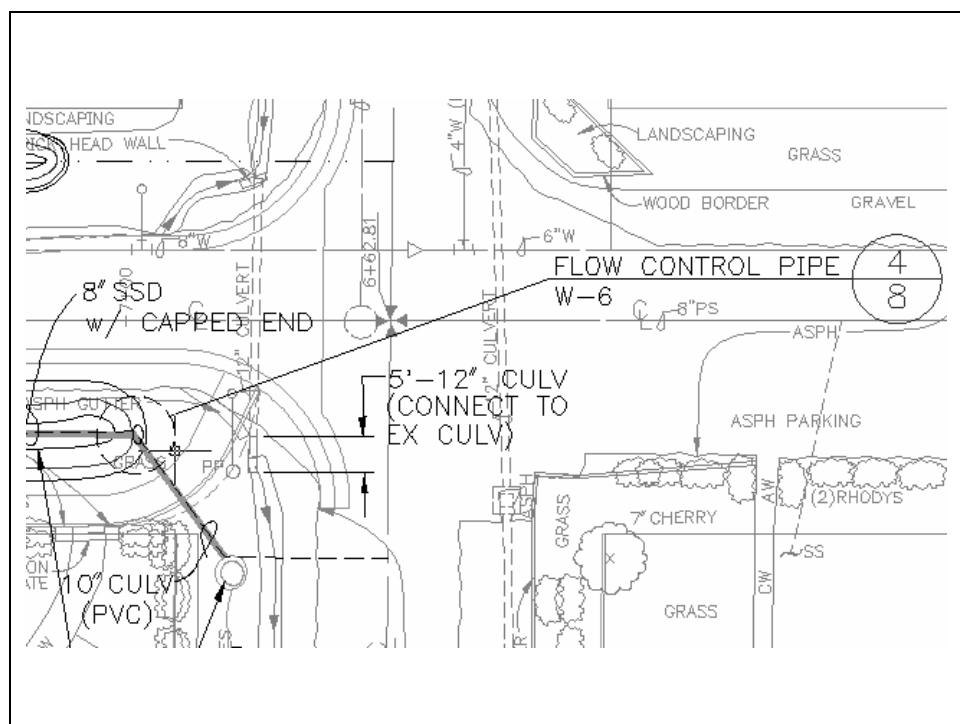

Figure 6-3. Portion of a typical as-built utility map depicting proposed modifications

6-6. Project Control for Topographic Detail Surveys

Topographic surveys of facilities, utilities, or terrain must be controlled to some reference framework, both in horizontal and vertical. This reference framework should consist of two or more permanently monumented control points and/or benchmarks located in the vicinity of the project. These project control points can then be used to perform supplemental topographic surveys of the project. This concept is illustrated in Figure 6-4 below. In this example of a survey site located along the Ohio River, NSRS control is brought in from three existing points using static GPS observations. A single point on the western end of the survey site is positioned. A baseline in the project area is established from the westernmost point using GPS. From these two intervisible points, subsequent topographic detail is surveyed using either a total station or RTK methods. LIDAR scans of the bridge across the Ohio River could be made relative to points set from the westernmost new point. In CONUS, connections are usually made to the NSRS. In OCONUS locales, connections to local reference frameworks can be made. Simple references to the satellite-based WGS-84 framework system may be also used, using a UTM grid for local reference. Vertical control is usually established relative to the nearest existing benchmarks. In

Figure 6-4 below, the points on the ends of the baseline would be tied in by differential levels to two or more of the local benchmarks shown.

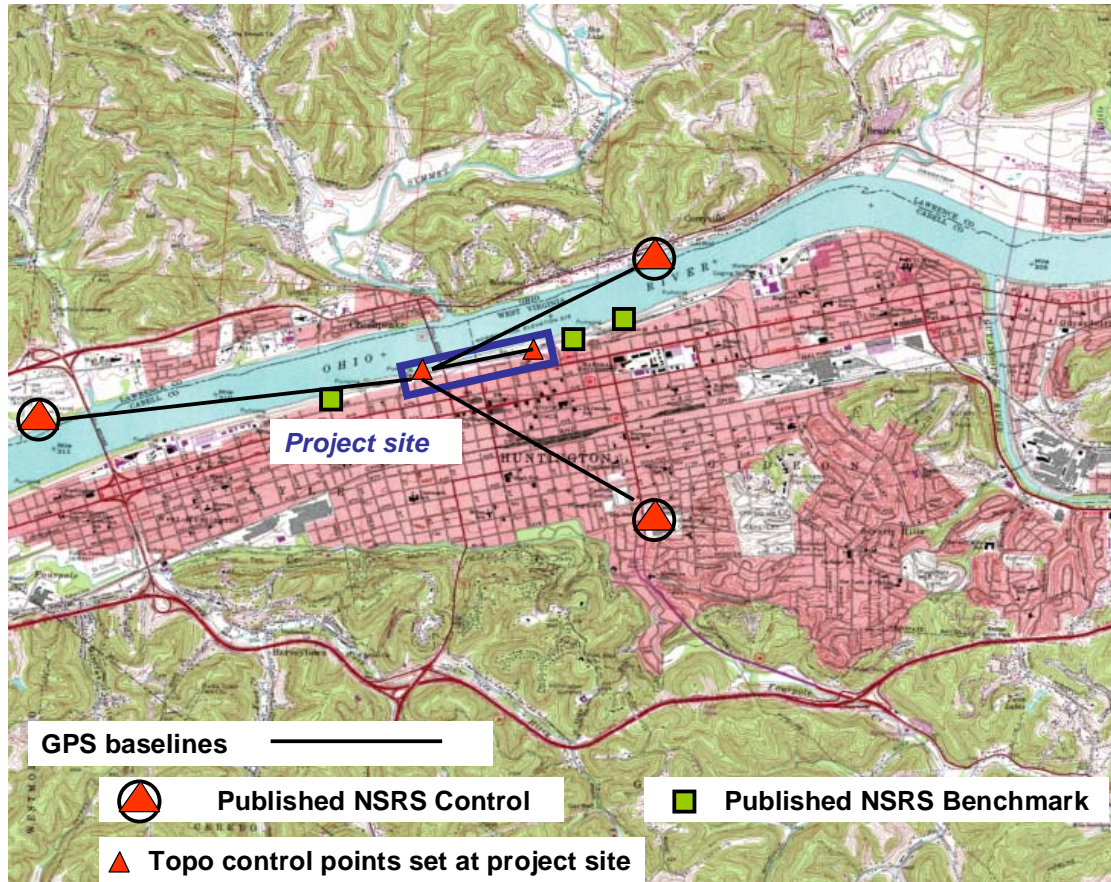

Figure 6-4. Project control: NSRS and local control

a. Project control relative accuracy. In general, horizontal and vertical accuracy of the control points used to control topographic surveys need only be to Third-Order, relative to themselves. In practice, if these control points in and around the project site have been interconnected by total station traverse, differential leveling, or static/kinematic DGPS techniques, their relative accuracy will be far greater--upwards of 1:50,000 to 1:100,000 type closures are expected. Positional accuracies within a project site should be around the ± 0.2 ft level in X-Y, and better than ± 0.1 ft in the vertical.

b. Project control absolute accuracy. The absolute accuracy of project control is that defined relative to some local, statewide, or nation-wide reference framework. These frameworks might be the NSRS that is maintained by the National Geodetic Survey or an installation geodetic network that was in turn connected to the NSRS. Maintaining a good relative accuracy with an adjoining installation project control network is far more important than accurate connections to distant NSRS networks. Likewise, connections to adjoining property boundary monuments are significantly more critical than connections to distant NSRS networks.

c. *Boundary control.* Topographic surveys involving real property boundaries must always be connected to established property corners, section corners, or adjoining right-of-way boundaries. Locations of structures, buildings, roads, utilities, etc. must be shown relative to the property boundaries. Likewise, stakeout of planned construction must be performed relative to these boundaries--and surveyed relative to applicable property corner pins. NSRS framework coordinates may be placed on property corner marks; however, subsequent stakeout work should never be performed relative to distant NSRS control--in other words, one should always occupy and/or connect to the nearest adjoining property boundary corners, as shown in Figure 6-5.

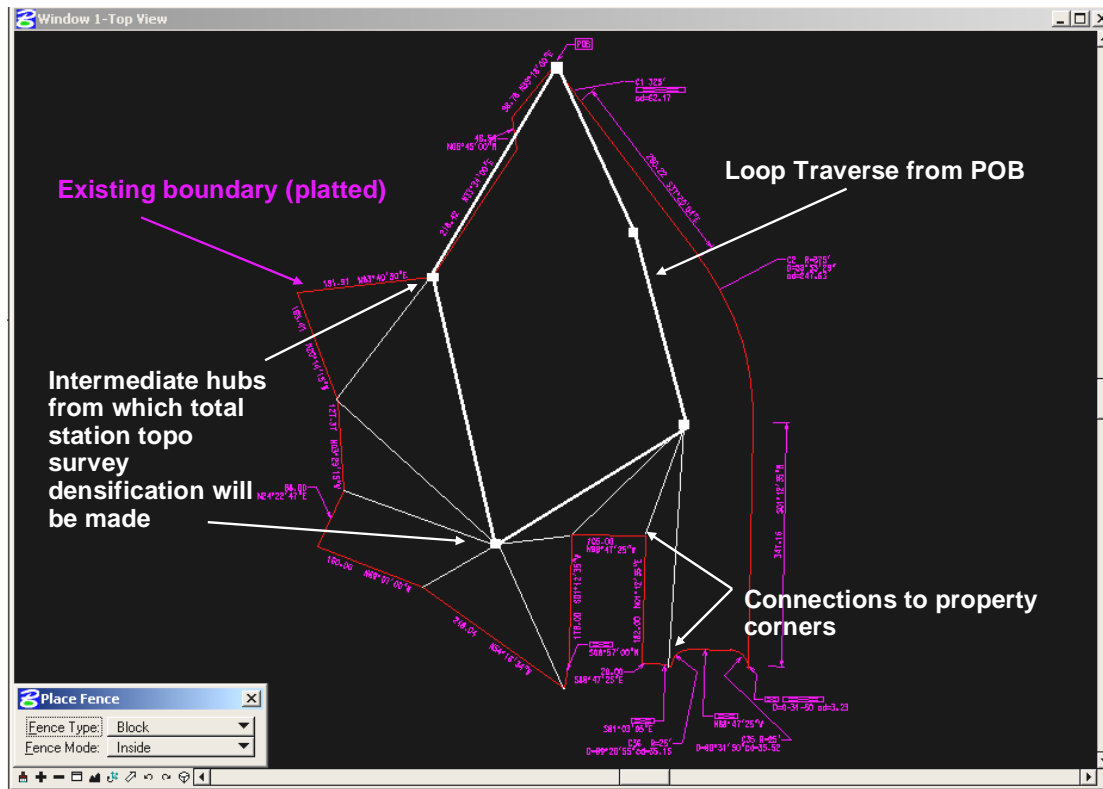

Figure 6-5. Setting additional topographic survey control points relative to platted property corners

d. *Local project control.* On some occasions, there is no existing horizontal or vertical control within the immediate vicinity of a project. Two options are available:

- Perform detailed surveys relative to an arbitrary coordinate system established for the project--e.g., set two permanent reference points, assume arbitrary coordinates of 5,000-10,000-100 (X-Y-Z) for one of the marks.
- Perform traverse, leveling, and/or GPS control surveys to bring in NSRS referenced control to the project site.

The first option listed above used to be more common; however, with the ease of extending control with GPS (either autonomous or differential), it is now fairly simple to establish some form of NSRS control on a project; or, at minimum, reference to the WGS 84 ellipsoid.

6-7. Establishing NSRS Control at a Project Site

A variety of factors must be considered in deciding whether and how to connect project sites to an external spatial coordinate network. These include:

- **Cost:** Bringing distant horizontal and vertical control to a project site can be costly, and may exceed the cost of performing the detailed topographic survey itself.
- **Policy.** Command, Agency, District, or Installation policy may mandate that all site plan work shall be referenced to the NSRS. If this is the case, then it is up to the surveyor to perform this connection in the most cost-effective manner as possible.
- **Accuracy (horizontal and vertical).** The horizontal and vertical accuracy of topographic features relative to the NSRS must be rigorously and sensibly defined. Most project sites have no real requirement for rigorous connections to a NSRS. For example, the horizontal location of a Reserve Center motor pool building need not have precise geographic coordinates relative to the NSRS. However, the location of a lock guidewall must be accurately located relative to the NSRS since this feature will be depicted on independent navigation charts. Likewise, the first floor elevation of the motor pool building relative to NGVD 29 is of little significance if the Reserve Center is located well outside any flood plain. For example, absolute NSRS positional accuracies of the motor pool building would be adequate at the ± 10 ft level in X-Y, and ± 3 ft in the vertical, whereas its local topographic survey accuracy relative to an adjoining property line would be around the ± 0.1 ft level in X-Y, and a floor elevation better than ± 0.02 ft relative to local utility connections.
- **Distance from NSRS network.** The distance useable published horizontal control points or vertical benchmarks are from the project site will have an impact on cost. In particular, if a distant benchmark requires a lengthy level line to bring in accurate vertical control, costs can rapidly escalate. More options are available for bringing in horizontal control to a project site, such as GPS static options using CORS networks.

Depending on many of the factors listed above (and many others), the method and accuracy of bringing in project control can be designed. The following paragraphs describe some of the common techniques that can be employed in establishing horizontal and vertical control relative to a NSRS network.

6-8. Project Control Densification Methods

a. Horizontal control. Horizontal control is most effectively connected to the NSRS published network into a project site by one of the following methods:

- Traverse surveys
- Static GPS surveys
- Kinematic GPS surveys

Traverse surveys with a total station are practical if the existing control is fairly close to the project site, i.e., within a few turning point setups. General procedures for performing conventional traverse surveys are covered in Chapter 3. If traverse surveys would take more than a few hours, then a static GPS observation may prove more practical. At least two external NSRS network points should be occupied. Alternatively, a static GPS survey could be conducted at a point set on the project site using the NGS

CORS network to adjust the point. Since most topographic site plan mapping surveys require only Third-Order accuracy relative to the NSRS, short-term (1 or 2 hour) GPS observations are normally the most cost-effective methods for extending control to a project site. Refer to EM 1110-1-1003 (*NAVSTAR GPS Surveying*) for details on performing and adjusting static GPS surveys.

b. Vertical control. If vertical control is required to a higher accuracy than can be achieved using GPS survey techniques, then conventional leveling methods must be used. Depending on the distance of the level run, Third-Order methods are usually sufficient. Either single-wire or digital leveling may be used. See EM 1110-1-1009 (*Structural Deformation Surveying*) if more accurate leveling methods are required--e.g., precise leveling with two-sided invar rods. Total station trigonometric leveling may be performed over short distances.

6-9. Extending Control from a Local Project or Installation Network (Patrick AFB)

Most topographic surveys are performed on existing installation or civil works project sites where NSRS or boundary control is readily available. Depending on the distance of this control from the survey site, either total station traverse or static GPS surveys are used to establish local control. Vertical control will typically be brought in by running Third Order levels from two existing benchmarks. If boundary surveys are required, then all property corners should be recovered and tied in as part of the survey. Figure 6-6 below (from a Trimble Geomatics Office screen capture) illustrates a constrained adjustment network for a Louisville District in-house control survey at an Army Reserve Center at Patrick AFB, Florida. GPS control is established from one-hour static and 5 to 15 min fast-static observations at three fixed NSRS control points--TECH 1961 (N-E-h) from the south, GPS 1009 (N-E) from the north, and BM PC1000 (e) from the south; where "N-E" are fixed horizontal coordinates, "h" is a fixed ellipsoidal height, and "e" is a fixed orthometric elevation. Station PAT1 at the Patrick AFB site is thereby controlled. From PAT1, 10 additional control points within the site are radiated from short-term (less than 5 min) kinematic GPS observations. These points are used as subsequent total station occupations.

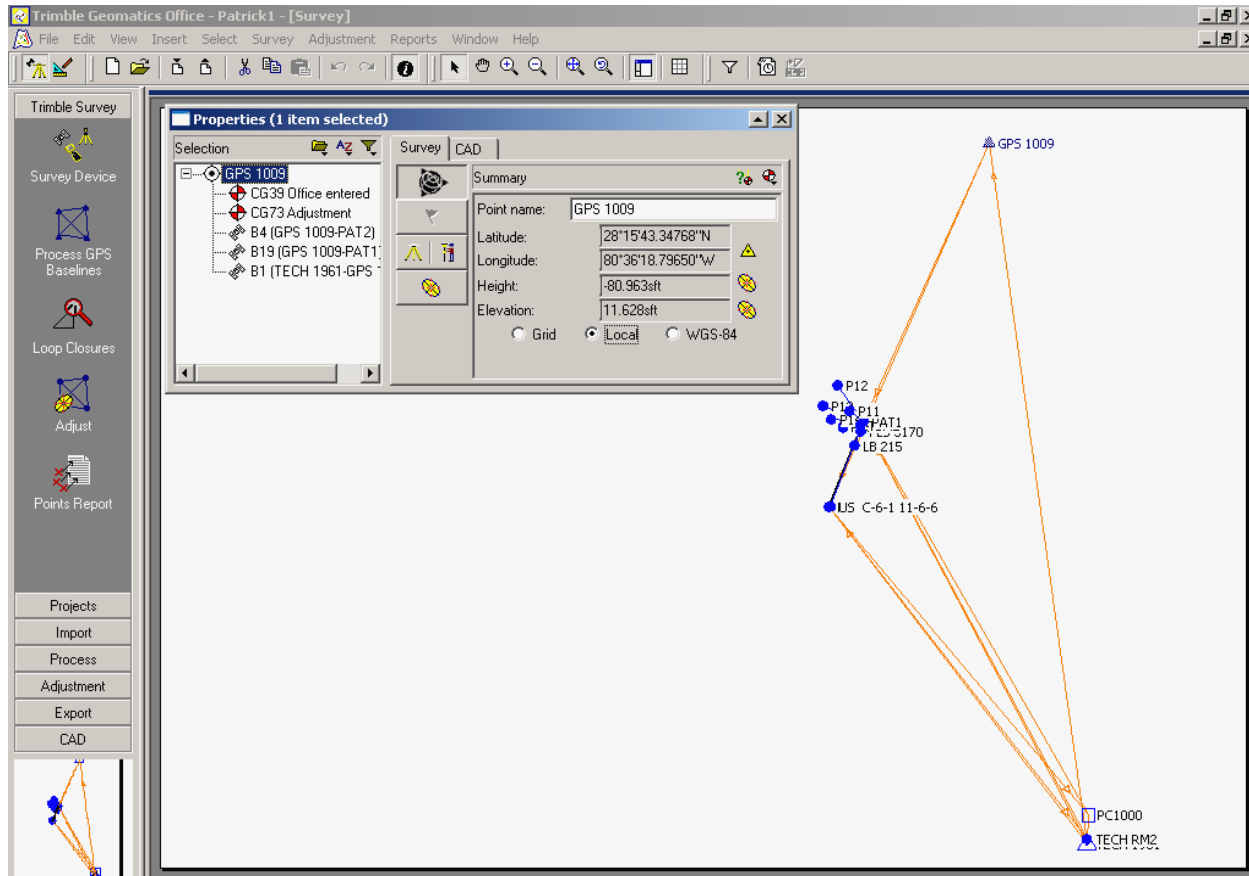

Figure 6-6. Horizontal and vertical control extended to project site from external NSRS points (Patrick AFB, Florida--Louisville District 2004)

Figure 6-7 below shows various control and topographic observations that were performed on the Patrick AFB survey. On this project, both total station and RTK topographic surveys were performed. The occupied radial points were positioned by fast static GPS observations from the primary installation/NSRS control point some 2,500 ft south of the site. The blue lines represent GPS baselines (Fast Static or RTK) and the green lines are terrestrial (total station) observations. All the observations were imported into TGO for a constrained adjustment (only redundant control points receive any adjustment--the radial RTK or total station observations are not adjusted).

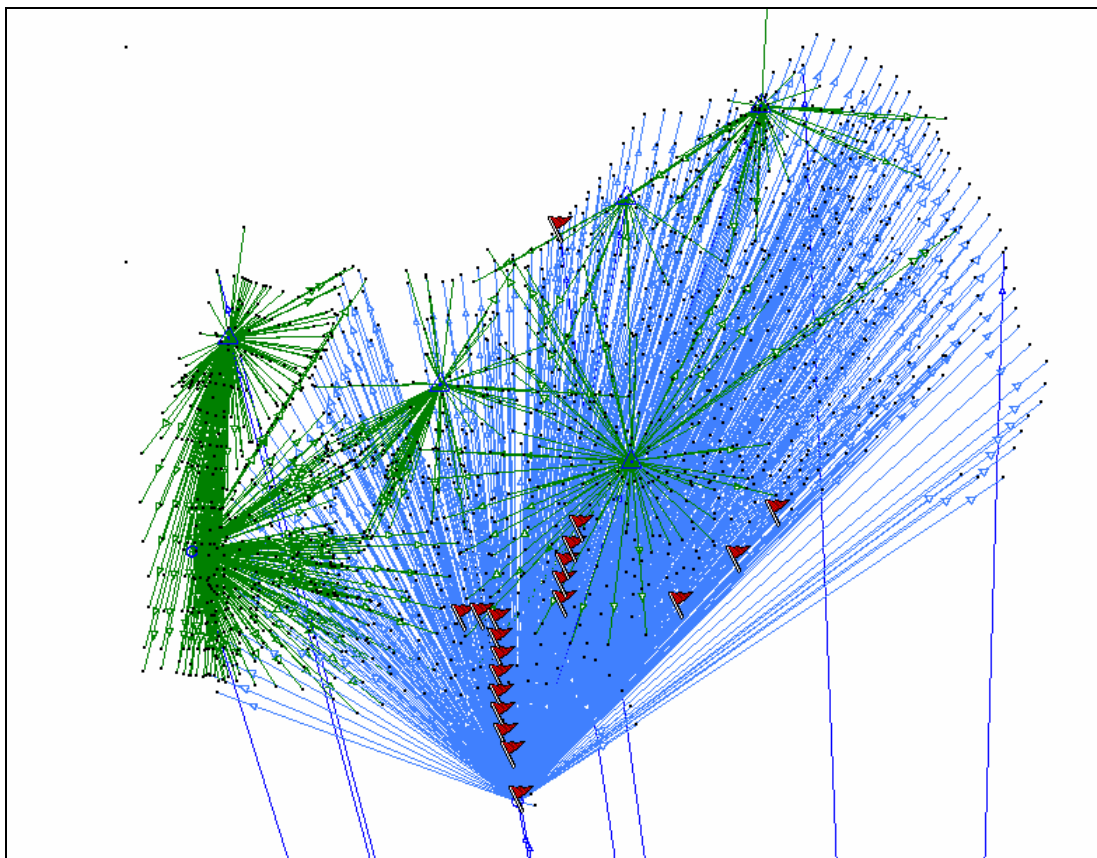

Figure 6-7. Total Station and RTK surveys at Patrick AFB (Louisville District 2004)

6-10. Extending Control from a Distant Network Using Continuously Operating Reference Stations (CORS)

The National Geodetic Survey coordinates the maintenance of a permanent network of continuously operating GPS receivers that can be used to establish NSRS control at virtually any place in CONUS. The use of CORS stations eliminates the need to occupy full baselines, as in the previous example. A single GPS receiver is set up at a primary control point in the project site, and 1 to 2 hour static GPS observations are recorded. These observations become the end of any number of selected baselines using stations in the CORS network. Static GPS observations made at a project site can be adjusted to any number of nearby CORS stations, using the NGS User Friendly CORS Web site, which is linked through the NGS Web Site at: <http://www.ngs.noaa.gov>.

a. The following example illustrates extending NSRS control to a project site using the CORS data network maintained by the NGS. Figure 6-8 below depicts an extension of NSRS control to a remote site where a detailed topographic survey is required. The point of this example is to illustrate a practical, rapid (one hour observing time), and cost-effective method of extending NSRS horizontal and vertical control into a project site. In this example (a structure survey on a remote mountain in Pennsylvania), a one-hour static GPS observation was made at a monument set near the facility to be surveyed. The specified NSRS absolute accuracy required was only ± 10 feet horizontal and ± 3 feet vertical. The one-hour static observation was connected to six CORS stations as shown below. The six baselines were reduced and an adjusted position for the topographic reference point was computed using least squares software.

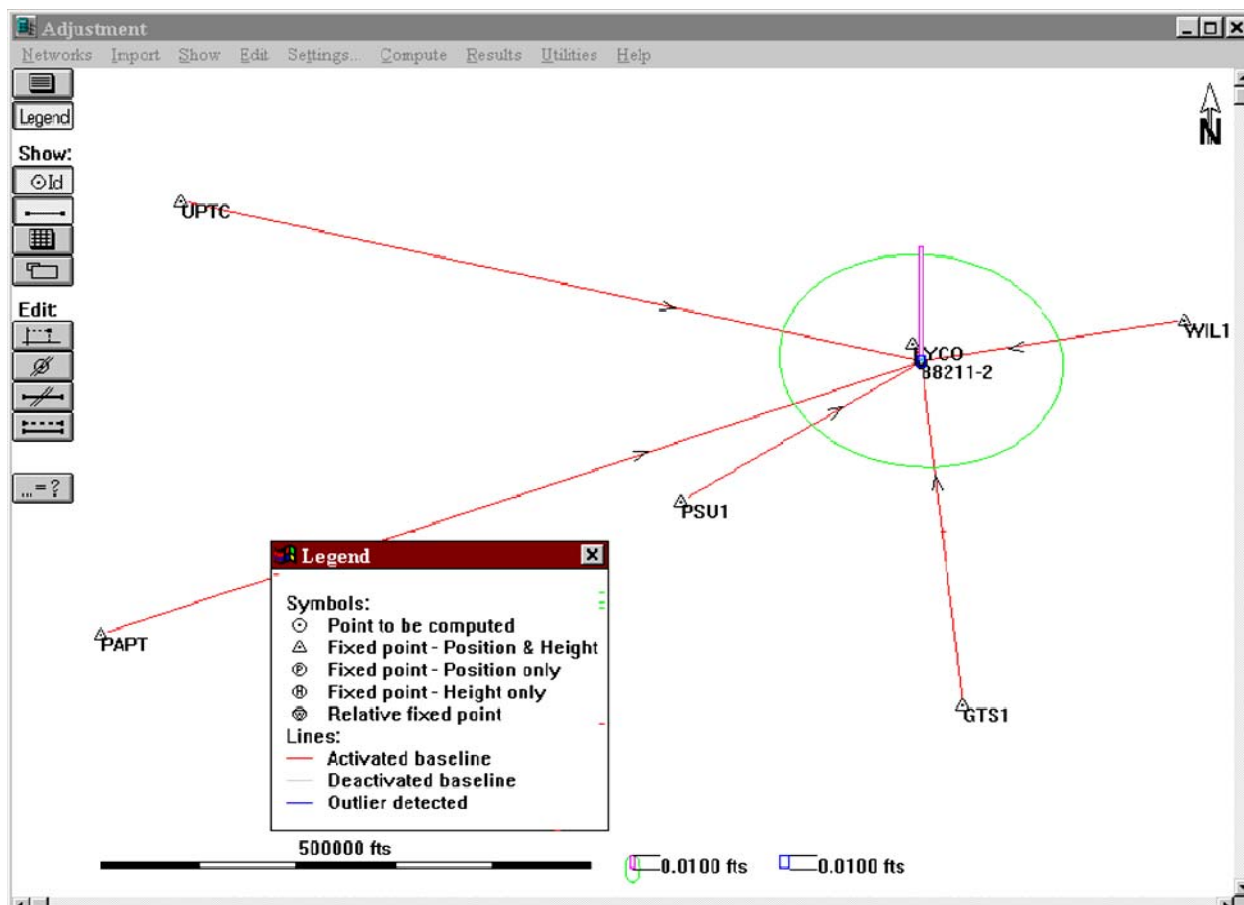

Figure 6-8. Connections to multiple CORS stations to adjust coordinates of a remote point (Leica SKI)

b. Figure 6-8 above shows the unknown control point “88211-2” being connected to six CORS stations at various locations in Pennsylvania--PAPT, PSU1, GTS1, UPTC, WIL1, and LYCO. RINEX data recorded for each of these CORS stations was downloaded from the Internet and each of the six baselines was reduced using standard baseline reduction software. A standard constrained adjustment using the weighted baseline reduction data is then performed to arrive at the adjusted position of the point “88211-2.” The output of this adjustment is shown below with notes shown in blue italics:

Adjustment type	:	Constrained	
Number of observations	:	18	<i>[6 baselines -- X, Y, and Z]</i>
Number of unknowns	:	3	
Degrees of freedom	:	15	
Number of groups	:	1	
88211-2	Lat:	41 11 30.397202 N ±	0.00960 [m] ± <i>0.03 ft</i>
	Lon:	76 58 35.163335 W ±	0.01280 [m] ± <i>0.04 ft</i>
	Hgt:	517.6770 m ±	0.01286 [m] ± <i>0.04 ft</i>

The above result indicates that the resultant CORS-adjusted position has a high relative accuracy estimate--at the ± 0.1 ft level. This accuracy is more than adequate to reference the horizontal location of

subsequent total station observations made from “88211-2.” The height shown (517.677 m) may have adjusted to the ± 0.1 ft level, but this elevation is based on the WGS 84 ellipsoid height reduced to NAVD 88 using the published geoid model (GEOID 03) at this location--a predicted correction. Thus, while this CORS-adjusted elevation is well within the ± 3 ft accuracy specification, use of the predicted geoid model may degrade the absolute accuracy to no better than ± 0.5 ft. If the project required a better vertical accuracy relative to adjacent utility systems, then conventional differential level lines should be run rather than use GPS-derived vertical elevations.

c. The following output from this CORS connection scheme shows a Leica SKI “Mean Position” option based on the six baselines (the mean position is not the same as the least squares position). Also shown are the differences in Lat-Long-Hgt for each baseline relative to the mean position. These differences clearly indicate that the more distant baselines (PAPT, GTS1, and UPTC) are of lesser quality; however, they would provide results well within the desired tolerances if used separately. In practice, not all six of these CORS observations would have been used on this project--they are used in this example for illustrative purposes to show that even CORS points 100 to 200 miles distant can provide fairly reliable results. Since CORS point LYCO was less than 10 miles away from the project site, and has a fixed baseline solution (all the others were “float” solutions), this CORS point and a second check point (e.g., PSU1) would have been adequate in practice. It is always advisable to include a third CORS site for a blunder check. CORS-derived positions can be computed the same day as the observations are made.

Mean coordinates and differences:

Point id: 88211-2

WGS84 Coordinates:

	<i>[WGS 83Lat-Long/NAVD 88 Hgt</i>	<i>Geocentric coordinates]</i>
Lat:	41 11 30.39723 N	X: 1083261.795 m
Lon:	76 58 35.16313 W	Y: -4683333.242 m
Hgt:	517.695 m	Z: 4178814.491 m

Reference	Date(YY/MM/DD)	dLat	dLon	dHgt
LYCO	04/05/28 12:58:25	-0.002 m	0.000 m	-0.005 m <i>fixed</i>
WILL	04/05/28 13:04:35	-0.003 m	0.090 m	0.078 m
GTS1	04/05/28 12:58:25	0.002 m	0.106 m	0.095 m
PAPT	04/05/28 12:58:25	-0.014 m	-0.077 m	0.175 m <i>> 150 miles</i>
UPTC	04/05/28 13:05:10	-0.022 m	0.123 m	0.060 m
PSU1	04/05/28 12:58:25	-0.022 m	-0.025 m	0.077 m

d. In obtaining CORS data sheets from the NGS, care must be taken to use the correct published coordinates shown on the sheet and input those values in the GPS adjustment program. The typical datasheet that is downloaded with a CORS dataset is shown below for a point in Ohio near Gallipolis Lock and Dam on the Ohio River--Figure 6-9 on the next page. On this example, the coordinates for antenna phase center (ARP) are used (note options regarding use of L1 and L2 phase centers). Ignore all “ITRF” positions--use only published NAD 83 positions. The ellipsoid height on this CORS sheet (169.501 m) is based on GPS observations at this point and is referenced to NAD 83. The NGS Data Sheet (Figure 6-10) for this point (PID = DF4048) shows its GEOID 03 height. No NAVD 88 elevation is indicated since this CORS ARP point has not been connected to the vertical network. These CORS position and ellipsoid heights can be changed and may not be the same as the downloaded RINEX position and ellipsoid heights. Thus, care must be taken when using CORS stations to ensure that coordinates used in the adjustment are those published. In rare cases, errors in published CORS ellipsoid heights have been encountered; thus, redundant CORS points are advised.

e. Azimuth orientation at the topographic project site is easily performed as part of the process of bringing in CORS control. A second GPS receiver is set up at a marked point 500 to 1,000 ft distant from the first GPS point. GPS observations over the short baseline are made concurrently with the CORS baseline connections. The fixed solution over this short baseline will provide adequate azimuth orientation for subsequent topographic work at the project site. (Note that a solid fixed solution is required over this baseline). Either end of the baseline can be used to fix the CORS-derived X-Y-Z position. The absolute accuracy over a 1,000 ft baseline will be between 10 and 30 seconds, depending on the quality of the short baseline solution. This azimuth is adequate assuming the survey site is small and no real property connections are required. If the site has deeded boundary alignments (e.g., bearings shown along a road or boundary), then these deeded bearings should be used for azimuth reference if this alignment is the established reference. GPS derived azimuths would have to be corrected to fit the local orientation.

```
Antenna Reference Point(ARP): GALLIPOLIS CORS ARP
-----
PID = DF4048

ITRF00 POSITION (EPOCH 1997.0)
Computed in Feb., 2003 using 24 days of data.
  X = 668399.969 m    latitude = 38 50 39.17620 N
  Y = -4929212.710 m longitude = 082 16 40.10632 W
  Z = 3978967.616 m    ellipsoid height = 168.250 m

ITRF00 VELOCITY
Predicted with HTDP_2.7 February 2003.
  VX = -0.0164 m/yr    northward = 0.0012 m/yr
  VY = -0.0017 m/yr    eastward = -0.0165 m/yr
  VZ = 0.0011 m/yr    upward = 0.0003 m/yr

NAD_83 POSITION (EPOCH 2002.0)
Transformed from ITRF00 (epoch 1997.0) position in Feb., 2003.
  X = 668400.506 m    latitude = 38 50 39.14896 N
  Y = -4929214.152 m longitude = 082 16 40.09229 W
  Z = 3978967.747 m    ellipsoid height = 169.501 m

NAD_83 VELOCITY
Transformed from ITRF00 velocity in Feb., 2003.
  VX = 0.0000 m/yr    northward = 0.0000 m/yr
  VY = -0.0001 m/yr    eastward = 0.0000 m/yr
  VZ = 0.0000 m/yr    upward = 0.0000 m/yr

L1 Phase Center of the current GPS antenna: GALLIPOLIS CORS L1 PC C
-----
The D/M element, chokerings, radome antenna
(Antenna Code = TRM29659.00 UNAV) was installed on 11/14/02.
The L2 phase center is 0.020 m above the L1 phase center.
PID = DF9327

ITRF00 POSITION (EPOCH 1997.0)
Computed in Feb., 2003 using 24 days of data.
  X = 668399.982 m    latitude = 38 50 39.17622 N
  Y = -4929212.792 m longitude = 082 16 40.10624 W
  Z = 3978967.684 m    ellipsoid height = 168.358 m

The ITRF00 VELOCITY of the L1 PC is the same as that for the ARP.

NAD_83 POSITION (EPOCH 2002.0)
Transformed from ITRF00 (epoch 1997.0) position in Feb., 2003.
  X = 668400.519 m    latitude = 38 50 39.14899 N
  Y = -4929214.235 m longitude = 082 16 40.09221 W
  Z = 3978967.815 m    ellipsoid height = 169.609 m

The NAD_83 VELOCITY of the L1 PC is the same as that for the ARP.
```

**Use NAD 83 POSITION of
ARP in Adjustment**

* Latitude, longitude, and ellipsoid height are computed from their corresponding Cartesian coordinates using dimensions for the GRS 80 ellipsoid:
semi-major axis = 6,378,137.0 meters flattening =1/298.257222101
* WARNING: Mixing of antenna types can lead to errors of up to 10 cm. in height unless antenna-phase-center variation is properly modeled.

Figure 6-9. CORS antenna reference data

The NGS Data Sheet

See file [dsdata.txt](#) for more information about the datasheet.

```

DATABASE = Sybase ,PROGRAM = datasheet, VERSION = 7.09
1      National Geodetic Survey,  Retrieval Date = NOVEMBER 16, 2004
DF4048 *****
DF4048  CORS          -   This is a GPS Continuously Operating Reference Station.
DF4048  DESIGNATION -   GALLIPOLIS CORS ARP
DF4048  CORS_ID      -   GALP
DF4048  PID          -   DF4048
DF4048  STATE/COUNTY-   OH/GALLIA
DF4048  USGS QUAD    -   RODNEY (1983)
DF4048                                     *CURRENT SURVEY CONTROL
DF4048
DF4048* NAD 83(CORS)-   38 50 39.14896(N)      082 16 40.09229(W)      ADJUSTED
DF4048* NAVD 88      -
DF4048
DF4048  EPOCH DATE   -           2002.00
DF4048  X            -           668,400.506 (meters)                COMP
DF4048  Y            -          -4,929,214.151 (meters)                COMP
DF4048  Z            -           3,978,967.746 (meters)                COMP
DF4048  ELLIP HEIGHT-           169.50 (meters)                    (02/??/03) GPS OBS
DF4048  GEOID HEIGHT-          -33.71 (meters)                    GEOID03
DF4048  HORZ ORDER  -   SPECIAL (CORS)
DF4048  ELLP ORDER  -   SPECIAL (CORS)
DF4048
DF4048. ITRF positions are available for this station.
DF4048. The coordinates were established by GPS observations
DF4048. and adjusted by the National Geodetic Survey in February 2003.
DF4048. The coordinates are valid at the epoch date displayed above.
DF4048. The epoch date for horizontal control is a decimal equivalence
DF4048. of Year/Month/Day.
DF4048. The PID for the CORS L1 Phase Center is DF9327.
DF4048
DF4048. The XYZ, and position/ellipsoidal ht. are equivalent.
DF4048
DF4048. The ellipsoidal height was determined by GPS observations
DF4048. and is referenced to NAD 83.
DF4048. The geoid height was determined by GEOID03.
DF4048
DF4048;           North           East           Units Scale Factor Converge.
DF4048; SPC OH S   -           93,742.541       619,289.825   MT  0.99998005   +0 08 27.6
DF4048
DF4048!           -   Elev Factor x Scale Factor = Combined Factor
DF4048! SPC OH S   -           0.99997341 x 0.99998005 = 0.99995346
DF4048
DF4048                                     SUPERSEDED SURVEY CONTROL
DF4048. No superseded survey control is available for this station.
DF4048
DF4048_U.S. NATIONAL GRID SPATIAL ADDRESS: 17SLD8910900264(NAD 83)
DF4048_MARKER: STATION IS THE ANTENNA REFERENCE POINT OF THE GPS ANTENNA
DF4048
DF4048                                     STATION DESCRIPTION
DF4048'DESCRIBED BY NATIONAL GEODETIC SURVEY 2003
DF4048'STATION IS A GPS CORS. LATEST INFORMATION INCLUDING POSITIONS AND
DF4048'VELOCITIES ARE AVAILABLE IN THE COORDINATE AND LOG FILES ACCESSIBLE
DF4048'BY ANONYMOUS FTP OR THE WORLDWIDE WEB.
DF4048' FTP CORS.NGS.NOAA.GOV: CORS/COORD AND CORS/STATION_LOG
DF4048' HTTP://WWW.NGS.NOAA.GOV UNDER PRODUCTS AND SERVICES.

```

Figure 6-10. NGS Data Sheet

6-11. On-Line Positioning User Service (OPUS)

OPUS is a free on-line baseline reduction and position adjustment service provided by the National Geodetic Survey. OPUS provides an X-Y-Z baseline reduction and position adjustment relative to three nearby national CORS reference stations. It performs the solution similarly to the manual adjustment illustrated above and can be used for establishing accurate horizontal control relative to the NSRS. It is simpler to operate in that only the user's observed data needs to be uploaded as opposed to downloading three or more CORS RINEX files. It can also be used as a quality control check on previously established control points. OPUS input is performed "on-line" by entering a required minimum period static, dual-frequency GPS RINEX, or other acceptable native format data. The resultant adjustment is returned in minutes via e-mail. Either the ultra-rapid or the precise ephemeris is used for the solution. OPUS is accessed at the following web page address: www.ngs.noaa.gov/OPUS. The various data on the web page screen are entered, e.g., e-mail address, RINEX file path, antenna height, and local SPCS code. The antenna height in meters is the vertical (not slope) distance measured between the monument/benchmark and the antenna reference point (ARP). The ARP is almost always the center of the bottom-most, permanently attached, surface of the antenna. If 0.0000 meters is entered for the height, OPUS will return the position of the ARP. The type of antenna is selected from the drop down menu. OPUS computes an average solution from the three baselines. NGS baseline reduction software is used for the solutions. Output positions are provided in both ITRF and NAD 83. An overall RMS (95%) confidence for the solution is provided, along with maximum coordinate spreads between the three CORS stations for both the ITRF and NAD 83 positions. An orthometric elevation on NAVD 88 is provided using the current geoid model. The orthometric accuracy shown is a function of the spread between the three redundant baseline solutions. OPUS is also recommended as a check on existing USACE control.

6-12. Establishing Approximate Control for an Isolated or OCONUS Construction Project

When confronted to perform a topographic survey for design or construction at a remote (OCONUS) project site, the following options are available:

- Establish a local (arbitrary) coordinate system--e., g., set and mark a primary point with X-Y-Z coordinates 10,000-10,000-100 (meters or feet). (It is recommended that the arbitrary X-Y coordinates be sufficiently different (e.g., 5,000-10,000) to avoid potential confusion between coordinates. Also ensure that negative coordinates will not occur over the project site).
- Set and mark a secondary point 500 to 1,000 ft distant for azimuth orientation.
- Establish the azimuth orientation between the two points (i.e. a baseline) using either:
 - Arbitrary azimuth of 000 deg.
 - Estimated azimuth (scaled from map or photo)
 - Magnetic azimuth (from transit or hand held compass)
 - Perform astronomic observation (Solar or Polaris)
 - Perform 8 to 15 minute GPS baseline observation, holding autonomous position at the primary end of the baseline
 - Gyroscope
- Perform topographic surveys relative to these two points. No grid or sea level corrections are applied to observed distances--a tangent plane grid is assumed.

a. No georeferenced control. Georeferenced control is rarely required for construction--an arbitrary system described above is totally adequate for all design, stakeout, and construction. In addition, an arbitrary grid system can be established in minutes--the baseline is quickly marked with stakes, hubs, rebar, or PK nails at each end. Topographic surveys using a total station or RTK can then be immediately conducted, starting at one end of the arbitrary baseline. If needed, supplemental control traverses can be run to set additional marked control points around the project site. Optionally, RTK radial control points can also be set relative to the baseline.

b. Georeferencing using autonomous GPS. If georeferenced control is required on this isolated project, then autonomous GPS positioning could be used to put approximate georeferencing on the primary control point. Georeferencing can be performed at any time. All data that was observed on the arbitrary grid system can later be translated (and rotated) to a planer georeferenced coordinate system. If only approximate georeferenced control is needed (± 20 ft), then an autonomous position from a hand-held GPS receiver is adequate (e.g., Garmin, PLGR), and noting on all survey records that any resultant coordinates are approximate. A few minute visual recording of the position is sufficient. Likewise, a quick autonomous GPS position on the other end of the baseline will establish a rough geodetic azimuth for the baseline--accurate to only ± 1 deg at best. If the receiver will convert Lat/Long to the local UTM zone, then the UTM coordinate system may be used to reference the project. A Lat/Long coordinate for the primary point on the baseline should not be shown to an accuracy greater than the nearest 0.1 second. A UTM coordinate should not be shown to better than the nearest meter.

c. Long-term static GPS observations. If a more precise georeferencing is required, then longer term static GPS observations must be made at the primary point on the baseline. Most GPS receivers can average long-term autonomous GPS positions-- over say 24 hours. This will derive a WGS 84 3D position accurate to approximately ± 2 meters. A higher accuracy (better than ± 1 meter) will be attained if geodetic quality GPS receivers are available. If two geodetic receivers are available, then a fixed solution can be achieved over the short baseline with only a few minutes of static observations.

d. Transformations. All databases and drawings must clearly note the approximate georeferencing of the project, the method by which it was performed, and the estimated accuracy of the primary reference point. Also clearly indicate that the project is referenced to WGS 84. The vertical datum is referenced either to the WGS 84 ellipsoid or to the approximate local geoid if a worldwide geoid model is available. Clearly note on drawings which vertical datum was held. If required, the project may also be referenced to a local OCONUS horizontal datum if the transformation parameters are known or are imbedded in the GPS receiver. Previous topographic observations on an arbitrary coordinate system may be transformed to the WGS 84/UTM grid using standard transformation routines found in most COGO software packages. These routines will also automatically apply grid and sea level corrections during the transformation--assuming these are significant.

6-13. Determining Required Map Scale and Contour Interval

General guidance for determining project-specific mapping requirements is contained in Table 6-1 at the end of this section and in Table 6-2 in the next section. Table 6-1 may be used to develop specifications for map scales, feature location tolerances, and contour intervals for typical engineering and construction projects. Functional activities are divided into military construction, civil works, real estate, hazardous waste, and emergency management. It is absolutely essential that surveying and mapping specifications originate from the functional requirements of the project, and that these requirements be realistic and economical. Specifying topographic map scales or accuracies in excess of those required for project planning, design, or construction results in increased costs to USACE, local sponsors, or installations, and may delay project completion. However, the recommended standards and accuracy tolerances shown in

Table 6-1 should be considered as general guidance for typical projects--variance from these norms is expected.

a. Mapping scope/limits. Mapping limits should be delineated so only areas critical to the project are covered by detailed ground topographic surveys. The areal extent of detailed, large-scale, site plan surveys should be kept to a minimum and confined to the actual building, utility corridor, or structure area. Outside critical construction perimeters, more economical smaller scale plans should be used, along with more relaxed feature location accuracies, larger contour intervals, etc.

b. Target scale and contour interval specifications. Map scale is the ratio of the distance measurement between two identifiable points on a map to the same physical points existing at ground scale. The errors in map plotting and scaling should exceed errors in measurements on the ground by a ratio of about 3 to 1. Stated in a different manner, a ratio can be established as a function of the plotter error divided by the allowable scale error. For example, if a digital plotter has an accuracy of 0.0008 ft (0.25 mm) and scaled map distances must be accurate to 0.5 ft, then $0.0008/0.5 \approx 1/600$; or the ratio becomes 1:600 or 1 inch = 50 feet. Table 6-1 provides recommended map scales and contour intervals for a variety of engineering applications. The selected target scale for a map or construction plan should be based on the detail necessary to portray the project site. Surveying and mapping costs will normally increase exponentially with larger mapping scales; therefore, specifying too large a site plan scale or too small a contour interval than needed to adequately depict the site can significantly increase project costs. Topographic elevation density or related contour intervals must be specified consistent with existing site gradients and the accuracy needed to define site layout, drainage, grading, etc., or perform quantity take offs. Photogrammetric mapping flight altitudes or ground topographic survey accuracy and density requirements are determined from the design map target scale and contour interval provided in the contract specifications.

c. Feature location tolerances. This requirement establishes the primary surveying effort necessary to delineate physical features on the ground. In most instances, a construction feature may need to be located to an accuracy well in excess of its plotted/scaled accuracy on a construction site plan; therefore, feature location tolerances should not be used to determine the required scale of a drawing or determine photogrammetric mapping requirements. In such instances, surveyed coordinates, internal CADD grid coordinates, or rigid relative dimensions are used. Table 6-1 indicates recommended positional tolerances (or precisions) of planimetric features. These feature tolerances are defined relative to adjacent points within the confines of a specific area, map sheet, or structure--not to the overall project or installation boundaries. Relative accuracies are determined between two points that must functionally maintain a given accuracy tolerance between themselves, such as adjacent property corners; adjacent utility lines; adjoining buildings, bridge piers, approaches, or abutments; overall building or structure site construction limits; runway ends; catch basins; levee baseline sections; etc. Feature tolerances should be determined from the functional requirements of the project/structure (e.g., field construction/fabrication, field stakeout or layout, alignment, locationing, etc.). Few engineering, construction, or real estate projects require that relative accuracies be rigidly maintained beyond a 5,000-ft range, and usually only within the range of the detailed design drawing for a project/structure (or its equivalent CADD design file limit). For example, two catch basins 200 ft apart might need to be located to 0.1 ft relative to each other, but need only be known to ± 100 ft relative to another catch basin 6 miles away. Likewise, relative accuracy tolerances are far less critical for small-scale GIS data elements. Actual construction alignment and grade stakeout will generally be performed to the 0.1 ft or 0.01 ft levels, depending on the type of construction.

d. Maintaining relative precision on a topographic survey. Ideally, all features located throughout a site area will have the same relative precision. In practice, the relative precision of the points located furthest from the project control points will tend to have more error than points located

directly from control monuments. In order to maintain the required accuracy for a project, a primary project control net or loop is established to cover the entire project. Secondary project control loops or nets are constructed from the primary project network. This helps to ensure that the intended precision will not drop below the tolerance of the survey. In lieu of increasing control requirements, the target map scale may be reduced in outlying areas. This trade-off between survey control and scale either increases project costs or the scale is reduced below usable limits in some cases.

e. Optimum target scale. The requesting agency (or surveyor) should always use the smallest scale which will provide the necessary detail for a given project. This will provide economy and meet the project requirements. Once the smallest practical scale has been selected given the recommended options from Table 6-1, determine if any other future map uses are possible for this project which might need a larger scale. If no other uses are of practical value, then the optimum map scale has been determined.

f. Determining optimum contour interval. The contour interval is the constant elevation difference between two adjacent contour lines. The contour interval is chosen based on the map purpose, required vertical accuracy (if any was specified), the relief of the area of concern, and somewhat from the map target scale. Steep slopes (large relief) will cause the surveyor to increase the contour interval in order to make the map more legible. Flat areas will tend to decrease the interval to a limit which does not interfere with planimetric details located on the topographic map.

(1) As a general rule, the lower limit for the contour interval is 25 lines per inch for even the smallest map scales. The checklist to find the proper contour interval is:

- Intended purpose of the map.
- The desired accuracy of the depicted vertical information.
- Area relief (mountainous, hilly, rolling, flat, etc.).
- Cost of extra field work and possibility of plotting problems for selecting a smaller contour interval.
- Other practical uses for the intended map.

(2) Following the above checklist, contour interval ranges are recommended in Table 6-1 for the types of projects typically encountered in USACE. If a specific vertical tolerance has been specified as the purpose for the mapping project, then the contour interval may be determined as a direct proportion from Table 6-1 for the type of project site. Otherwise, the stated map accuracy of the vertical information will be in terms of the selected contour interval within the limits provided by Table 6-1.

(3) Any contour drawn on the map will be correct to a stated fraction of the selected contour interval. Because interpolation is used between spot elevations, the spot elevations themselves are required to be twice as precise as the contours generated by the spot elevations.

g. CADD level/layer descriptors. The use of CADD or GIS equipment allows planimetric features and topographic elevations to be readily separated onto various levels or layers and depicted at any scale. Problems may arise when scales are increased beyond their originally specified values, or when so-called "rubber sheeting" or "warping" is performed. It is therefore critical that these geospatial data layers, and related metadata files, contain descriptor information identifying the original source target scale and designed accuracy.

**Table 6-1. RECOMMENDED ACCURACIES AND TOLERANCES:
ENGINEERING, CONSTRUCTION, AND FACILITY MANAGEMENT PROJECTS**

Project or Activity	Target	Feature Position Tolerance		Contour	Survey
	Map Scale SI/IP	Horizontal SI/IP	Vertical SI/IP	Interval SI/IP	Accuracy Hor/Vert
DESIGN, CONSTRUCTION, OPERATION & MAINTENANCE OF MILITARY FACILITIES					
Maintenance and Repair (M&R)/Renovation of Existing Installation Structures, Roadways, Utilities, Etc					
General Construction Site Plans & Specs:	1:500	100 mm	50 mm	250 mm	3rd-I
Feature & Topographic Detail Plans	40 ft/in	0.1-0.5 ft	0.1-0.3 ft	1 ft	3rd
Surface/subsurface Utility Detail Design Plans	1:500	100 mm	50 mm	N/A	3rd-I
Elec, Mech, Sewer, Storm, etc	40 ft/in	0.2-0.5 ft	0.1-0.2 ft		3rd
Field construction layout		0.1 ft	0.01-0.1 ft		
Building or Structure Design Drawings	1:500	25 mm	50 mm	250 mm	3rd-I
40 ft/in	0.05-0.2 ft	0.1-0.3 ft	1 ft	3rd	
Field construction layout		0.01 ft	0.01 ft		
Airfield Pavement Design Detail Drawings	1:500	25 mm	25 mm	250 mm	3rd-I
40 ft/in	0.05-0.1 ft	0.05-0.1 ft	0.5-1 ft	2nd	
Field construction layout		0.01 ft	0.01 ft		
Grading and Excavation Plans	1:500	250 mm	100 mm	500 mm	3rd-II
Roads, Drainage, Curb, Gutter etc.	30-100 ft/in	0.5-2 ft	0.2-1 ft	1-2 ft	3rd
Field construction layout		1 ft	0.1 ft		
Recreational Site Plans	1:1000	500 mm	100 mm	500 mm	3rd-II
Golf courses, athletic fields, etc.	100 ft/in	1-2 ft	0.2-2 ft	2-5 ft	3rd
Training Sites, Ranges, and Cantonment Area Plans	1:2500	500 mm	1000 mm	500 mm	3rd-II
	100-200 ft/in	1-5 ft	1-5 ft	2 ft	3rd
General Location Maps for Master Planning	1:5000	1000 mm	1000 mm	1000 mm	3rd-II
AM/FM and GIS Features	100-400 ft/in	2-10 ft	1-10 ft	2-10 ft	3rd
Installation boundaries, roads, buildings	100 ft/in				
Installation regional location	2,000 ft/in				
Installation vicinity map	1,000 ft/in				
Space Management Plans	1:250	50 mm	N/A	N/A	N/A
Interior Design/Layout	10-50 ft/in	0.05-1 ft			
As-Built Maps: Military Installation Surface/Subsurface Utilities (Fuel, Gas, Electricity, Communications, Cable, Storm Water, Sanitary, Water Supply, Treatment Facilities, Meters, etc.)	30 to 100 ft/in	100 mm	100 mm	250 mm	3rd-I
		0.2-1 ft	0.2 ft	1 ft	3rd
	1:1000 or 50-100 ft/in (Army)				
	1:500 or 50 ft/in (USAF)				

**Table 6-1 (Contd). RECOMMENDED ACCURACIES AND TOLERANCES:
ENGINEERING, CONSTRUCTION, AND FACILITY MANAGEMENT PROJECTS**

Project or Activity	Target	Feature Position Tolerance		Contour Survey	Accuracy Hor/Vert
	Map Scale SI/IP	Horizontal SI/IP	Vertical SI/IP	Interval SI/IP	
Housing Management GIS (Family Housing, Schools, Boundaries, and Other Installation Community Services)	1:5000 100-400 ft/in	10000 mm 10-15 ft	N/A	N/A	4th 4th
Environmental Mapping and Assessment Drawings/Plans/GIS	1:5000 400 ft/in	10000 mm 10-50 ft	N/A	N/A	4th 4th
Emergency Services Maps/GIS Military Police, Crime/Accident Locations, Post Security Zoning, etc.	1:10000 400-2000 ft/in	25000 mm 50-100 ft	N/A	N/A	4th 4th
Cultural, Social, Historical Plans/GIS Archeological sites, habitat, endangered species, wildlife, wetlands	1:5000 400 ft/in	10000 mm 20-100 ft	N/A	N/A	4th 4th
Runway Approach and Transition Zones: General Plans/Section Approach maps Approach detail Runway end location	1:2500 100-200 ft/in 1:5000 (H) 1:5000 (H) N/A	2500 mm 5-10 ft 1:1000 (V) 1:250 (V) 1 ft	2500 mm 2-5 ft 0.2 ft	1000 mm 5 ft N/A	3rd-II 3rd 3rd
Airport Obstruction & NAVAID Surveys Airport Obstructions NAVAID-visual NAVAID-electronic--radar NAVAID-WAAS (absolute) NAVAID-WAAS (relative) Primary & Secondary Control Points	N/A N/A N/A N/A N/A N/A	20 ft 20 ft 20 ft 5 cm 1 cm 3 cm	3 ft N/A 100 ft 10 cm 0.2 cm 4 cm	N/A N/A N/A N/A N/A N/A	3rd-II 3rd-II 3rd-II 3rd 2nd 2nd
<u>DESIGN, CONSTRUCTION, OPERATIONS AND MAINTENANCE OF CIVIL TRANSPORTATION & WATER RESOURCE PROJECTS</u>					
Site Plans, Maps & Drawings for Design Studies, Reports, Memoranda, and Contract Plans and Specifications, Construction plans & payment					
General Planning and Feasibility Studies, Reconnaissance Reports	1:2500 100-400 ft/in	1000 mm 2-10 ft	500 mm 0.5-2 ft	1000 mm 2-10 ft	3rd-II 3rd
Flood Control and Multipurpose Project Planning, Floodplain Mapping, Water Quality Analysis, and Flood Control Studies	1:5000 400-1000 ft/in	10000 mm 20-100 ft	100 mm 0.2-2 ft	1000 mm 2-5 ft	3rd-II 3rd
Soil and Geological Classification Maps 400 ft/in	1:5000 20-100 ft	10000 mm	N/A	N/A 4th	4th
Land Cover Classification Maps 400-1000 ft/in	1:5000 50-200 ft	10000 mm	N/A	N/A 4th	4th

**Table 6-1. (Contd). RECOMMENDED ACCURACIES AND TOLERANCES:
ENGINEERING, CONSTRUCTION, AND FACILITY MANAGEMENT PROJECTS**

Project or Activity	Target Map Scale SI/IP	Feature Position Horizontal SI/IP	Tolerance Vertical SI/IP	Contour Interval SI/IP	Survey Accuracy Hor/Vert
Archeological or Structure Site Plans & Details (Including Non-topographic, Close Range, Photogrammetric Mapping)	1:10 0.5-10 ft/in	5 mm 0.01-0.5 ft	5 mm 0.01-0.5 ft	100 mm 0.1-1 ft	2nd-I/II 2nd
Cultural and Economic Resource Mapping Historic Preservation Projects	1:10000 1000 ft/in	10000 50-100 ft	N/A	N/A	4th 4th
Land Utilization GIS Classifications Regulatory Permit Locations	1:5000 400-1000 ft/in	10000 mm 50-100 ft	N/A	N/A	4th 4th
Socio-Economic GIS Classifications	1:10000 1000 ft/in	20000 mm 100 ft	N/A	N/A	4th 4th
Grading & Excavation Plans	1:1000 100 ft/in	1000 mm 0.5-2 ft	100 mm 0.2-1 ft	1000 mm 1-5 ft	3rd-I 3rd
Flood Control Structure Clearing & Grading Plans (e.g., revetments)	1:5000 100-400 ft/in	2500 mm 2-10 ft	250 mm 0.5 ft	500 mm 1-2 ft	3rd-II 3rd
Federal Emergency Management Agency Flood Insurance Studies	1:5000 400 ft/in	1000 mm 20 ft	250 mm 0.5 ft	1000 mm 4 ft	3rd-I 3rd
Locks, Dams, & Control Structures Detail Design Drawings	1:500 20-50 ft/in	25 mm 0.05-1 ft	10 mm 0.01-0.5 ft	250 mm 0.5-1 ft	2nd-II 2nd/3rd
Spillways & Concrete Channels Design Plans	1:1000 50-100 ft/in	100 mm 0.1-2 ft	100 mm 0.2-2 ft	1000 mm 1-5 ft	2nd-II 3rd
Levees and Groins: New Construction or Maintenance Design Drawings	1:1000 100 ft/in	500 mm 1-2 ft	250 mm 0.5-1 ft	500 mm 1-2 ft	3rd-II 3rd
Construction In-Place Volume Measurement Granular cut/fill, dredging, etc.	1:1000 40-100 ft/in	500 mm 0.5-2 ft	250 mm 0.5-1 ft	N/A	3rd-II 3rd
Beach Renourishment/Hurricane Protection Project Plans	1:1000 100-200 ft/in	1000 mm 2 ft	250 mm 0.5 ft	250 mm 1 ft	3rd-II 3rd

**Table 6-1. (Contd). RECOMMENDED ACCURACIES AND TOLERANCES:
ENGINEERING, CONSTRUCTION, AND FACILITY MANAGEMENT PROJECTS**

Project or Activity	Target	Feature Position Tolerance		Contour Survey	
	Map Scale SI/IP	Horizontal SI/IP	Vertical SI/IP	Interval SI/IP	Accuracy Hor/Vert
Project Condition Survey Reports					
Base Mapping for Plotting Hydrographic Surveys: line maps or aerial plans	1:2500 200-1000 ft/in	10000 mm 5-50 ft	250 mm 0.5-1 ft	500 mm 1-2 ft	N/A N/A
Dredging & Marine Construction Surveys					
New Construction Plans--Rock	1:1000 100 ft/in	2000 mm 6 ft	250 mm 1 ft	250 mm 1 ft	N/A N/A
New Construction Plans--Soft material	100 ft/in	6 ft	2 ft	1 ft	N/A
Maintenance Dredging Drawings	1:2500 200 ft/in	2000 mm 6 ft	500 mm 1 or 2 ft	500 mm 1 ft	N/A N/A
Offshore Geotechnical Investigations Core Borings /Problings/etc.	-	5000 mm 5-15 ft	50 mm 0.1-0.5 ft	N/A	N/A 4th
Structural Deformation Monitoring Studies/Surveys					
Reinforced Concrete Structures: Locks, Dams, Gates, Intake Structures, Tunnels, Penstocks, Spillways, Bridges	Large-scale vector movement diagrams or tabulations	10 mm 0.03 ft (long-term)	2 mm 0.01 ft	N/A	N/A N/A
Earth/Rock Fill Structures:Dams,Floodwalls, (same as Levees, etc--slope/crest stability & alignment	above)	30 mm 0.1 ft (long term)	15 mm 0.05 ft	N/A	N/A N/A
Crack/Joint & Deflection Measurements: piers/monoliths--precision micrometer	tabulations	0.2 mm 0.01 inch	N/A	N/A	N/A N/A

**Table 6-1. (Concluded). RECOMMENDED ACCURACIES AND TOLERANCES:
ENGINEERING, CONSTRUCTION, AND FACILITY MANAGEMENT PROJECTS**

Project or Activity	Target	Feature Position Tolerance		Contour Survey	
	Map Scale SI/IP	Horizontal SI/IP	Vertical SI/IP	Interval SI/IP	Accuracy Hor/Vert
<u>REAL ESTATE ACTIVITIES: ACQUISITION, DISPOSAL, MANAGEMENT, AUDIT</u>					
Maps, Plans, & Drawings Associated with Military and Civil Projects					
Tract Maps, Individual, Detailing					
Installation or Reservation Boundaries, Lots, Parcels, Adjoining Parcels, and Record Plats, Utilities, etc.	1:1000 1:1200 (Army) 50-400 ft/in	10 mm 0.05-2 ft	100 mm 0.1-2 ft	1000 mm 1-5 ft	3rd-I/II 3rd
Condemnation Exhibit Maps	1:1000 50-400 ft/in	10 mm 0.05-2 ft	100 mm 0.1-2 ft	1000 mm 1-5 ft	3rd-I/II 3rd
Guide Taking Lines/Boundary Encroachment Maps: Fee and Easement Acquisition	1:500 20-100 ft/in	50 mm 0.1-1 ft	50 mm 0.1-1 ft	250 mm 1 ft	3rd-I/II 3rd
General Location or Planning Maps	1:24000 2000 ft/in	10000 mm 50-100 ft	5000 mm 5-10 ft	2000 mm 5-10 ft	N/A 4th
GIS or Land Information System (LIS) Mapping, General					
Land Utilization and Management, Forestry Management, Mineral Acquisition	1:5000 200-1000 ft/in	10000 mm 50-100 ft	N/A	N/A	3rd 3rd
Easement Areas and Easement Delineation Lines	1:1000 100 ft/in	50 mm 0.1-0.5 ft	50 mm 0.1-0.5 ft	N/A	3rd 3rd
<u>HAZARDOUS, TOXIC, RADIOACTIVE WASTE (HTRW) SITE INVESTIGATION, MODELING, AND CLEANUP</u>					
General Detailed Site Plans HTRW Sites, Asbestos, etc.	1:500 5-50 ft/in	100 mm 0.2-1 ft	50 mm 0.1-0.5 ft	100 mm 0.5-1 ft	2nd-I/II 2nd/3rd
Subsurface Geotoxic Data Mapping and Modeling	1:500 20-100 ft/in	100 mm 1-5 ft	500 mm 1-2 ft	500 mm 1-2 ft	3-II 3rd
Contaminated Ground Water Plume Mapping/Modeling	1:500 20-100 ft/in	1000 mm 2-10 ft	500 mm 1-5 ft	500 mm 1-2 ft	3rd-II 3rd
General HTRW Site Plans & Reconnaissance Mapping	1:2500 50-400 ft/in	5000 mm 2-20 ft	1000 mm 2-20 ft	1000 mm 2-5 ft	3rd-II 3rd

EXPLANATORY NOTES FOR COLUMNS IN TABLE 6-1:

1. Target map scale is that contained in CADD, GIS, and/or AM/FM layer, and/or to which ground topo or aerial photography accuracy specifications are developed. This scale may not always be compatible with the feature location/elevation tolerances required. In many instances, design or real property features are located to a far greater relative accuracy than that which can be scaled at the target (plot) scale, such as property corners, utility alignments, first floor or invert elevations, etc. Coordinates/elevations for such items are usually directly input into a CADD or AM/FM database.

2. The feature position or elevation tolerance of a planimetric feature is defined at the 95% confidence level. The positional accuracy is relative to two adjacent points within the confines of a structure or map sheet, not to the overall project or installation boundaries. Relative accuracies are determined between two points that must functionally maintain a given accuracy tolerance between themselves, such as adjacent property corners; adjacent utility lines; adjoining buildings, bridge piers, approaches, or abutments; overall building or structure site construction limits; runway ends; catch basins; levee baseline sections; etc. The tolerances between the two points are determined from the end functional requirements of the project/structure (e.g., field construction/fabrication, field stakeout or layout, alignment, locationing, etc.).

3. Horizontal and vertical control survey accuracy refers to the procedural and closure specifications needed to obtain/maintain the relative accuracy tolerances needed between two functionally adjacent points on the map or structure, for design, stakeout, or construction. Usually 1:10,000 Third-Order (I) control procedures (horizontal and vertical) will provide sufficient accuracy for most engineering work, and in many instances of small-scale mapping or GIS rasters, Third-Order, Class II methods and Fourth-Order topo/construction control methods may be used. Base- or area-wide mapping control procedures shall be specified to meet functional accuracy tolerances within the limits of the structure, building, or utility distance involved for design or construction surveys. Higher order control surveys shall not be specified for area-wide mapping or GIS definition unless a definitive functional requirement exists (e.g., military operational targeting or some low gradient, flood control projects).

6-14. Recommended Guidelines for Army Installation Maps and Drawings

Table 6-2 below is extracted from the "CADD/GIS Technology Center Guidelines for Installation Mapping and Geospatial Data" (ERDC/ITL 1999b). It contains guidance on recommended scales for various types of military installation maps. The map class refers to the ASPRS standards (ASPRS 1989).

Table 6-2 Recommended Installation Mapping Guidelines					
<i>NOTE: UNLESS OTHERWISE SPECIFIED THE INSTALLATION LAYOUT MAP WILL BE USED AS A BASE FOR THE PREPARATION OF OTHER SPECIFIED MAPS.</i>					
MAP AND GRAPHIC LAYERS <i>M=mandatory</i> <i>O=optional</i> <i>TBD=to be determined</i>		MAP SCALE 1"=xxxxft	MAP CLASS-ACCURACY	CONTOUR INTERVAL (feet)	DESCRIPTION AND FEATURES SHOWN
A- NATURAL AND CULTURAL RESOURCES A-1 AREAS OF CRITICAL CONCERN	M	1"=400ft 1:4,800	Class 1	5	Shows historic and archeological sites, areas of threatened and endangered species, primary habitat areas, flood plains, wetlands, coastal zones, lakes, rivers, water bodies, soils and soil boring locations, and similar information.
A- NATURAL AND CULTURAL RESOURCES A-2 MANAGEMENT AREAS	O	1"=400ft 1:4,800	Class 1	5	Shows surface/subsurface geology, paleontology, topography, hydrology and surface drainage, vegetation areas, forests, commercial timber areas, agricultural outleasing areas, fish and wildlife areas, prime soils, grounds maintenance areas, outdoor recreation areas, pest management areas, and similar information.

**Table 6-2
Recommended Installation Mapping Guidelines**

NOTE: UNLESS OTHERWISE SPECIFIED THE INSTALLATION LAYOUT MAP WILL BE USED AS A BASE FOR THE PREPARATION OF OTHER SPECIFIED MAPS.

B- ENVIRONMENTAL QUALITY B-1 ENVIRONMENTAL REGULATORY AREAS	M	1"=400ft 1:4,800	Class 1	5	Shows hazardous waste generation points, hazardous waste storage facilities, solid waste disposal and recycling points, fuel tanks, Resource Conservation and Recovery Act sites, installation restoration program sites/areas, and similar information.
B- ENVIRONMENTAL QUALITY B-2 ENVIRONMENTAL EMISSIONS AREAS	O	1"=400ft 1:4,800	Class 1	5	Shows sources of air emissions, wastewater Non-point Pollution Discharge Elimination System (NPDES) point source discharges, storm water non-point discharges, drinking water supply, electromagnetic radiation sources, sources of radon emissions and similar information.
C-INSTALLATION LAYOUT AND VICINITY C-1 INSTALLATION LAYOUT	M	1"=100ft 1:1,200	Class 1	2	Shows the installation boundary; buildings (facility identification numbers and type: permanent, semi-permanent, temporary); structures; roads and parking areas; walkways and trails; railroads; fences; recreation areas; cemeteries; training ranges; contours; water areas; coordinate grid; embankments; below/above ground tanks; embankments; spot elevations and survey control; neighboring land use (outside installation boundary); historic buildings and places, archeological sites and similar information.
C-INSTALLATION LAYOUT AND VICINITY C-2 OFF-INSTALLATION SITES	M	1"=400ft 1:4,800	Class 1	5	Shows the same information as the installation layout map, but this map is prepared for those facilities that are outside the installation's primary boundary.
C-INSTALLATION LAYOUT AND VICINITY C-3 INSTALLATION REGIONAL LOCATION	O	1"=2,000ft 1:24,000	NA	20	Shows information of interest to regional planning and major transportation systems, cities, towns, political jurisdictions, DoD installation boundaries, aeronautical data, woodlands, recreation areas, towers, significant physical characteristics of the region and other similar information.
C-INSTALLATION LAYOUT AND VICINITY C-4 INSTALLATION VICINITY	O	1"=1000ft 1:12,000	Class 1	10	Shows the installation boundary, airfield and operations areas, major roads, proposed roads and highways, railroads, bombing and test ranges, vertical obstructions, topography, recreation areas, waterways and bodies, towers and similar information.

Table 6-2 Recommended Installation Mapping Guidelines					
<i>NOTE: UNLESS OTHERWISE SPECIFIED THE INSTALLATION LAYOUT MAP WILL BE USED AS A BASE FOR THE PREPARATION OF OTHER SPECIFIED MAPS.</i>					
C-INSTALLATION LAYOUT AND VICINITY C-5 AERIAL PHOTOGRAPHIC COVERAGE AND CONTROL STATIONS	O		NA	NA	Prepared as an index of the aerial photographic coverage for the installation, shows the center point of individual photographs as well as the location of survey control stations and control points used for the aerial photography.
C-INSTALLATION LAYOUT AND VICINITY C-6 INSTALLATION BOUNDARY	M	Legal Records	Class 1	1	Shows the land area comprising the installation boundary including survey monuments.
D- LAND USE D-1 INSTALLATION LAND USE D-1.1 FUTURE LAND USE	M	1"=400ft 1:4,800	Class 1	5	Shows installation land use including airfields; maintenance and repair areas; manufacturing industrial areas; supply/ storage areas; administration areas; training and ranges areas; troop and family housing; community facilities (commercial and service); medical facilities; outdoor recreation; open spaces; and similar information
D- LAND USE D-2 OFF SITE LAND USE D-2.1 FUTURE OFF SITE LAND USE	O	1"=400ft 1:4,800	Class 1	5	Shows off-site land use including airfields; maintenance and repair areas; manufacturing industrial areas; supply/ storage areas; administration areas; training and ranges areas; troop and family housing; community facilities (commercial and service); medical facilities; outdoor recreation; open spaces; and similar information
D- LAND USE D-3 REAL ESTATE	O	1"=400ft 1:4,800	Class 1	2	Shows the land area comprising the installation including parcel information on fee title, lease, license, permit and easement areas inclusive of tract, acreage, data of acquisition, lease period and similar information.
D- LAND USE D-4 EXPLOSIVE SAFETY QUANTITY-DISTANCE CLEARANCE ZONES (QD-ARCS)	M	1"=400ft 1:4,800	Class 1	5	Same as installation layout map, but includes the distance clearance zones for explosives.
D- LAND USE D-5 HAZARD ANALYSIS CONSTRAINTS	M	1"=400ft 1:4,800	Class 1	5	Same as installation layout map, but includes areas of catastrophic potential to include flooding, subsidence, avalanche, erosion, earthquake, tsunami, snowfall, windstorm, volcanic ash and similar information.
D- LAND USE D-6 COMPOSITE CONSTRAINTS	M	1"=400ft 1:4,800	Class 1	5	Same as installation layout map, but emphasizes areas of catastrophic potential from natural occurrences e.g., flooding, subsidence, avalanche, earthquake, tsunami and technological occurrences, accident potential zones, hazardous noise areas, noise contours, environmental

Table 6-2
Recommended Installation Mapping Guidelines

NOTE: UNLESS OTHERWISE SPECIFIED THE INSTALLATION LAYOUT MAP WILL BE USED AS A BASE FOR THE PREPARATION OF OTHER SPECIFIED MAPS.

					management areas and other similar information.
D- LAND USE D-7 AREA DEVELOPMENT	O	1"=100ft 1:1,200	Class 1	2	Same as installation layout map, but includes information on the planned development of areas within the installation.
E-AIRFIELD OPERATIONS E-1 ON-BASE OBSTRUCTIONS TO AIRFIELD CRITERIA	M	1"=1,000ft 1:12,000	Class 1	5	Same as airport pavement map and includes information on any obstructions to navigation and ground movement of aircraft within the installation boundary.
E-AIRFIELD OPERATIONS E-2 APPROACH/DEPARTURE ZONE OBSTRUCTIONS (to 10,000 feet)	M	1"=800ft	Class 1	5	Shows obstructions within the glide angle approach zone and other similar information within the distance specified.
E-AIRFIELD OPERATIONS E-3 APPROACH/DEPARTURE ZONE OBSTRUCTIONS (from 10,000 feet to 10 miles)	M	1"=2,000ft 1:24,000	Class 1	10	Shows obstructions within the glide angle approach zone and other similar information within the distance specified.
E-AIRFIELD OPERATIONS E-4 AIRSPACE OBSTRUCTION-VICINITY	M	1"=1,000ft 1:12,000	Class 1	10	Shows obstructions within the vicinity of the airfield, but not those already shown on approach/departure zone maps, topography, cities, towns, other obstructions, water courses and water bodies and similar information.
E-AIRFIELD OPERATIONS E-5 TERMINAL ENROUTE PROCEDURES (TERPS) AUTOMATION	M	TBD	TBD	TBD	Shows all NAVAIDS with latitude and longitude.
E-AIRFIELD OPERATIONS E-6 AIRFIELD/AIRSPACE CLEARANCES	O	1"=100ft 1:1,200	Class 1	2	Shows airfield waivers, clear zones, primary surface, transitional surface (7:1), approach and departure surface (50:1) approach and taxiway clearances, wing tip clearances, turning radii, and other similar information necessary for aircraft movement on the ground.
E-AIRFIELD OPERATIONS E-7 AIRFIELD PAVEMENT	O	1"=400ft 1:4,800	Class 1	5	Shows runways, taxiways, aprons, warm-up pads, hardstands, helipads, stabilized shoulders, overruns and similar information.
E-AIRFIELD OPERATIONS E-8 AIRFIELD PAVEMENT DETAILS	O	1"=100ft 1:1,200	Class 1	2	Shows runways, taxiways, aprons, warm-up pads, hardstands, helipads, stabilized shoulders, overruns and similar information, but includes cross sections and elevation profiles.
E-AIRFIELD OPERATIONS E-9 AIRCRAFT PARKING E-9.1 PROPOSED AIRCRAFT PARKING	O	1"=100ft 1:1,200	Class 1	2	Shows the parking plan for aircraft including alert hangars, refueling outlets, blast fences, aircraft orientation, control tower, fire station, cargo holding pads, maintenance

Table 6-2
Recommended Installation Mapping Guidelines

NOTE: UNLESS OTHERWISE SPECIFIED THE INSTALLATION LAYOUT MAP WILL BE USED AS A BASE FOR THE PREPARATION OF OTHER SPECIFIED MAPS.

					docks, maintenance lights, aircraft revetments and similar information.
E-AIRFIELD OPERATIONS E-10 AIRFIELD LIGHTING SYSTEMS	O	1"=100ft 1:1,200	Class 1	2	Shows the major components of airfield lighting system including runway, taxiway, end reference lights, location size and type of underground ducts, obstruction lights, stand-by generator equipment and similar information.
F- Reserved					
G-UTILITY SYSTEMS G-1 WATER SUPPLY SYSTEM	M	1"=50ft 1:600	Class 1	1	Shows all significant components of the water supply system.
G-UTILITY SYSTEMS G-2 SANITARY SEWERAGE SYSTEM	M	1"=50ft 1:600	Class 1	1	Shows all significant components of the sanitary sewerage system.
G-UTILITY SYSTEMS G-3 STORM DRAINAGE SYSTEM	M	1"=50ft 1:600	Class 1	1	Shows all significant components of the storm drainage system.
G-UTILITY SYSTEMS G-4 ELECTRICAL DISTRIBUTION SYSTEM (STREET AND AIRFIELD)	M	1"=50ft 1:600	Class 1	2	Shows all significant components of the electrical distribution and exterior lighting systems.
G-UTILITY SYSTEMS G-5 CENTRAL HEATING/COOLING SYSTEMS	M	1"=50ft 1:600	Class 1	1	Shows all significant components of the central heating/cooling systems.
G-UTILITY SYSTEMS G-6 NATURAL GAS DISTRIBUTION SYSTEM	M	1"=50ft 1:600	Class 1	2	Shows all significant components of the natural gas distribution system.
G-UTILITY SYSTEMS G-7 LIQUID FUEL SYSTEM	M	1"=50ft 1:600	Class 1	1	Shows all significant components of the liquid fuel system.
G-UTILITY SYSTEMS G-8 CATHODIC PROTECTION SYSTEM	O	1"=100ft 1:1,200	Class 1	2	Shows all significant components of the cathodic protection system for all underground utility systems and structures subject to electrochemical corrosion.
G-UTILITY SYSTEMS G-9 CATHODIC PROTECTION SYSTEM DETAILS	O	1"=50ft 1:600	Class 1	2	Shows all significant components of the cathodic protection system including details of other utilities in proximity to ground beds for all underground utility systems.
G-UTILITY SYSTEMS G-10 INDUSTRIAL WASTE AND DRAIN SYSTEM	O	1"=50ft 1:600	Class 1	2	Prepared when these systems are of such a complexity or nature it requires the production of a separate map to portray their characteristics.
G-UTILITY SYSTEMS G-11 COMPOSITE UTILITY SYSTEM	M	1"=100ft 1:1,200	Class 1	2	Shows the water, sanitary sewer, storm drainage, electrical, central heating/cooling, gas compressed air, industrial waste and other utility systems combined on a single map.

Table 6-2
Recommended Installation Mapping Guidelines

NOTE: UNLESS OTHERWISE SPECIFIED THE INSTALLATION LAYOUT MAP WILL BE USED AS A BASE FOR THE PREPARATION OF OTHER SPECIFIED MAPS.

G-UTILITY SYSTEMS G-11.1 CENTRAL AIRCRAFT SUPPORT SYSTEMS	O	1"=50ft 1:600	Class 1	2	Shows all the utilities systems that serve the airfield apron and related servicing of aircraft.
G-UTILITY SYSTEMS G-12 FIRE PROTECTION SYSTEMS AND UTILITIES	M	1"=400ft 1:4,800	Class 1	5	Shows fire hydrants, water deluge systems, safety buffer distances, vehicle maneuverability areas, and similar information related to fire protection or safety.
G-UTILITY SYSTEMS G-13 OTHER UTILITY SYSTEMS	O	1"=100ft 1:1,200	Class 1	2	Show utilities not displayed on other maps.
H-COMMUNICATION AND NAVAID SYSTEMS H-1 INSTALLATION-WIDE COMMUNICATIONS AND COMPUTER SYSTEMS	M	1"=400ft 1:4,800	Class 1	5	Uses the installation layout map as a base to show installation-wide communications systems.
H-COMMUNICATION AND NAVAID SYSTEMS H-2 NAVAID SYSTEMS	M	1"=400ft 1:4,800	Class 1	5	Shows NAVAID components such as radio transmitters, radio relay facilities, high and ultra high frequency direction finders, radio beacon shelters, GCA units, RAPCON units, PAR structures, TACAN buildings and facilities and similar information.
I-TRANSPORTATION SYSTEM I-1 COMMUNITY NETWORK - ACCESS TO BASE	M	1"=400ft 1:4,800	Class 1	10	Shows all major arterial, collector streets that have direct relationship to the installation and local streets providing access to the installation.
I-TRANSPORTATION SYSTEM I-2 ON-BASE NETWORK	M	1"=400ft 1:4,800	Class 1	2	Shows the transportation network including parking areas, sidewalks, bike/hike/jogging trails on the installation.
I-TRANSPORTATION SYSTEM I-2.1 FUTURE ON-BASE NETWORK	O	1"=400ft 1:4,800	Class 1	2	Shows the planned transportation network including parking areas, sidewalks, bike/hike/jogging trails on the installation.
J-ENERGY SYSTEMS	O	1"=100ft 1:1,200	Class 1	2	Shows data related to the installation's energy planning systems.
K-ARCHITECTURAL COMPATIBILITY	O	1"=400ft 1:4,800	Class 1	2	Shows the installation's architectural compatibility zones and architectural districts.
L-INSTALLATION LANDSCAPE DEVELOPMENT AREA	O	1"=400ft 1:4,800	Class 1	2	Shows the installation's landscape areas and planned flora.
M-FUTURE DEVELOPMENT M-1 CURRENT	M	1"=400ft 1:4,800	Class 1	5	Shows the current installation layout; e.g. streets, parking lots, buildings, utilities etc, to include those facilities presently under development.
M-FUTURE DEVELOPMENT M-2 FUTURE DEVELOPMENT SHORT-TERM (1-5 YEARS)	M	1"=400ft 1:4,800	Class 1	5	Shows planned development on the installation including streets and parking lots, buildings, utilities and

Table 6-2 Recommended Installation Mapping Guidelines					
<i>NOTE: UNLESS OTHERWISE SPECIFIED THE INSTALLATION LAYOUT MAP WILL BE USED AS A BASE FOR THE PREPARATION OF OTHER SPECIFIED MAPS.</i>					
					similar information.
M-FUTURE DEVELOPMENT M-2 FUTURE DEVELOPMENT SHORT-TERM (> 5 YEARS)	M	1"=400ft 1:4,800	Class 1	5	Shows the facilities that will be developed beyond a five-year time frame on the installation including streets and parking lots, buildings, utilities and similar information.
O-FORCE PROTECTION O-1 SURGE CAPABILITY (BEDDOWN AND SUPPORT)	O	1"=400ft 1:4,800	Class 1	5	Show areas that can be suited for temporary billeting of troops in the case of surge requirements.
O-FORCE PROTECTION O-2 PHYSICAL SECURITY	M	1"=400ft 1:4,800	Class 1	5	Shows security fences, proposed and existing access points, sensor devices, location of security police units, fire stations and other similar information.
O-FORCE PROTECTION O-3 DISASTER PREPAREDNESS CRASH GRID	M	1"=400ft 1:4,800	Class 1	5	Shows all buildings and building numbers with hospitals and fallout shelters, protection factors and similar information.
O-FORCE PROTECTION O-4 INSTALLATION SURVIVABILITY	O	1"=400ft 1:4,800	Class 1	5	Prepared for installations to show operational contingencies.
P-PORTS AND HARBORS	O	1"=100ft 1:1,200	Class 1	2	Shows berths, breakwater, channel, cable and pipeline areas, hazard areas, dry dock, navigation aides, jetties, wrecks, bouys, piers, quays, reefs, safety fairway, wharf, and other similar information.
R- TRAINING COMPLEX R-1 RANGE AREA	O	1"=400ft 1:4,800	Class 1	5	Shows surface danger zones, target areas, impact areas, dudded areas, bomb circles, firing points, firing fans and lanes, range control points, and other similar information.
R- TRAINING COMPLEX R-2 TRAINING AREA	O	1"=400ft 1:4,800	Class 1	5	Shows landing zones, drop zones, bivouac areas, training sites, foot traffic areas, perimeter defense, obstacle course areas, drill fields, marching areas and other similar information.

6-15. Topographic Survey Equipment Selection and Planning Guidance

This section discusses the selection of topographic survey instruments and methods for a given project. There is no set formula for deciding on a particular instrument (transit-tape, transit-stadia, plane table, total station, RTK, Laser) or survey densification technique (cross-sections, grid matrix, random). This is because of the large number of variables involved that will impact the use of one instrument or method versus another. These variables also have a major impact on productivity and cost. Some of these variables are discussed in the following paragraphs.

- **Size of project.** A simple stakeout of a baseball field can be accomplished easily with a transit and 100/300 ft steel tape--a total station or RTK would be overkill for such a project. On the other hand, a detailed site plan survey of a multi-acre planned commissary site would require a more productive instrument, such as a total station or RTK.
- **Complexity of project.** If only ground elevation shots are required at a site, survey data hand recorded in a field book would suffice. A project with many different feature levels, and with attribute options for each feature, would be more effectively surveyed using an electronic data collector--with a "field-finish" option if available.
- **Project location.** A remote or hazardous site location may dictate the type of equipment used. Lengthy mob/demob travel times will significantly increase costs, as will sites that can only be reached on foot.
- **Project time constraints.** A quick delivery suspense date may require use of electronic "field-finish" survey techniques; perhaps even laser techniques if a complex structure is involved. Specified overtime may increase costs.
- **Project cost constraints.** Always a driving factor--may preclude use of terrestrial laser technique. Or the cost may dictate a one-man crew with a robotic total station.
- **User/requestor preferences.** The originating office may have a preference for a particular survey method, including detailed data acquisition specifications. This user preference may or may not be the most economical method.
- **Project accuracy specifications.** The requested accuracy requirements from the using office may be unrealistically tight, and may preclude using a particular method even though it might have sufficed for the work. For example, if 0.2 ft horizontal accuracy is specified for all feature locations, a transit-tape or transit-stadia survey method is ruled out. Over specifying accuracy is probably the biggest cost driver on a project.
- **Tree coverage.** Dense canopy cover will eliminate use of RTK methods. If canopy is low (less than 20 to 25 ft) an expandable prism pole may be used to reach over the canopy.
- **Ground vegetation.** Heavy ground vegetation typically precludes use of laser/LIDAR survey methods. If vegetation is thick, line clearing may be needed to obtain direct total station shots. RTK may be more productive in such areas.
- **Above ground and underground utility detail required.** If complex utility infrastructure needs to be mapped, a total station may be the most practical method. If detailed attribute sketches are required, a

pen tablet type notebook may be preferable to a field book. Utility work can represent 50% or more of the survey cost.

- Site elevation relief. A site with high relief will make obtaining ground shots difficult, particularly if climbing or rappelling is required to access shot points. This might occur on highly complex mechanical facilities where it is difficult to occupy overhead HVAC lines with a reflector or GPS antenna. Site relief will also be a major factor in productivity estimates, particularly if dense vegetation is also involved. A reflectorless total station may be the best solution in these areas.

- Ground topographic shot density requirements. Usually the terrain gradient dictates the shot density required to model the ground. In some cases, the requesting agency may dictate a certain "post spacing," which may or may not make any sense given the ground relief. Determining the optimum shot spacing density has traditionally been left to the experienced field surveyor. This was the case when a plane table was the method of choice for developing site plans for design. The field Party Chief based the amount of ground relief detail he collected on the project design requirement, and verified coverage before leaving the field. This is still true of electronic data collectors--the Party Chief must confirm that the shot density is sufficient to generate a DTM that is adequate for the project purpose. The critical component is the project purpose--dense topographic data is not needed on a site where little, if any, excavation will be performed. Thus, it is critical that the Party Chief have knowledge of the planned/proposed design and construction effort, and base the collection density on that criteria.

- Instrument availability. Not all survey organizations have a full complement of instrumentation technologies available. A smaller firm may have only an electronic total station but has not invested in an expensive RTK system.

- Instrument data collection productivity. Data collection productivity is highly dependent on the type of feature data being collected and the instrument used to collect the data. Collection rates can be as long as a few minutes per feature in the case of a transit or plane table where slope distances must be hand reduced and recorded or plotted. Transit and plane table surveys typically collected between 100 and 200 points in a day. The other extreme is a terrestrial laser that can collect thousands of points/sec (without any attribution). Data collection rates for a total station or RTK system are roughly the same--both use a similar data collection system with nearly identical COGO options. Continuous ground shot points can be collected every few seconds--as long as it takes the rod/prism-person to move between points. (Some systems have a "continuous" tracking mode which will update the points every second or so). When different features are shot, the descriptor codes (and perhaps attributes) must be entered into the data collector. If a two-digit descriptor code is used, shots can be completed in a few seconds. Additional time will be required depending on the amount of attribution. A feature requiring a detailed field sketch may require a few minutes to complete. Thus, depending on the nature of the project and features, a total station or RTK system can collect anywhere from 300 to 2,000 points in a day.

- Data collector requirements. The requesting agency may dictate a particular data collector format be used, in addition to mandating use of a data collector itself (no field book option).

- Final product deliverable format. The requesting agency usually mandates a specific CADD or GIS deliverable format. This may impact the field data collection method.

- Crew or instrument operator experience. Plane table surveys are probably not a survey option any more given few experienced plane table operators are still employed. Most engineers and surveyors can operate a transit or level, read stadia, or use a steel tape. Thus, these methods would be effective for a

small topographic survey or stake out if a total station crew is unavailable. ("Small" means less than one day).

The following tables provide rough guidance for determining the density of shots needed to delineate planimetric features and terrain topography.

Table 6-3. Nominal Data Density Shot Intervals for Various Planimetric Features

Planimetric Feature	Recommended Spacing of Shots along Feature Target Scale		
	1" = 30 ft	1" = 50 ft	1" = 100 ft
Linear features (curbs, roads, buildings, utilities)	30 ft	50 ft	100 ft
Irregular features (breaklines, contours, shoreline, walkways, etc.)	10 ft	15 ft	30 ft
Rectangular or circular utility features (junction boxes, manholes, catch basins, etc.) detail corners or perimeter limits if objects maximum dimension is larger than	5 ft	10 ft	20 ft
Circular curves (roads, curbs, etc.) Delineate curve with	3 points	3 points	3 points

Table 6-4. Nominal Post Spacing Intervals and Density (Shots per Acre) for Topographic Ground Detail

Terrain Gradient (% slope)	Recommended Post Spacing (Density) of Shots on Ground Contour Interval		
	1 ft	2 ft	5 ft
< 1 %	50 ft (25 pts/acre)	100 ft (10 pts/acre)	250 ft (4 pts/acre)
< 5 %	10 ft (440 pts/acre)	20 ft (120 pts/acre)	50 ft (25 pts/acre)
<10 %	5 ft (1,600 pts/acre)	10 ft (440 pts/acre)	25 ft (80 pts/acre)
> 10 %	[as required to delineate feature]		

Given the large number of variables listed above, estimating topographic survey productivity is difficult--especially if underground utility location is required. Past experience on similar sites is probably the most reliable estimate. Use of estimating ratios, such as "acres/day" and "\$/acre" may be of some value; however, these ratios are only representative to a particular site. For example, the 30-acre site in Appendix G (*Topographic Survey of Hannibal Lock & Dam, Proposed Nationwide DGPS Antenna Site (Pittsburgh District)*) was surveyed at a cost of \$425/acre at a productivity rate of 5 acres/day. This is a relatively flat, clear site (mowed grass with isolated trees), with few utilities. If this site had been heavily vegetated and treed, requiring extensive line clearing, the cost/acre could easily have doubled or tripled.

Table 6-5. Matrix of Estimated Productivity Rates (Acres/Day) for Various Site Conditions

Nominal Site Condition	Estimated rate (acres/day)
------------------------	----------------------------

Topography

Flat, clear ground (no vegetation)	5 to 10 acres/day
Flat, isolated trees	4 to 8 acres/day
Flat, heavily treed (traverse reqd)	3 to 6 acres/day
Flat, heavily treed & vegetated (traverse & line cutting)	1 to 2 acres/day
Rolling terrain, clear ground (no vegetation)	3 to 5 acres/day
Rolling terrain, isolated trees	1 to 2 acres/day
Rolling terrain, heavily treed	0.5 to 1 acres/day
Rolling terrain, heavily treed & vegetated	0.2 to 0.5 acres/day

Planimetry

Rural, isolated buildings & roads	10 acres/day
Urban, subdivision	1 acre/day
Installation, military	2 acres/day
Lock and Dam area	2 acres/day

Chapter 7 Field Data Collectors and Coordinate Geometry Functions

7-1. Purpose

This chapter provides guidance on data collectors that are used to record topographic field data observed with total stations and RTK systems. Data collector features are described along with standard coordinate geometry (COGO) options. Some traditional route surveying parameters are also outlined at the end of the chapter.

7-2. Field Survey Notes--Manual and Electronic

Field survey notes can be collected either manually or electronically. Manual methods include field books or plane table sheets. Electronic methods include both internal and external data collectors interfaced with various survey instruments (total station, GPS receiver, or LIDAR). Electronic data collectors record, store, and transfer field data without the need to key in individual measurements, providing significant time savings in gathering and processing field data and eliminating reading and recording errors. However, not all supplemental feature data or detail sketches are easily encoded in a data collector. It is often better to draw detailed sketches of critical features in a traditional field survey book; or optionally on a digital notebook tablet. Sketches of features can also be supplemented with digital photos--video and digital cameras can be used to supplement the field sketch and provide a very good record of the site conditions for the CADD operator, design engineer, and user of the topographic map. Each District will have their own policy regarding how field notes are to be kept--manually and/or electronically. An important distinction is made when written field notes are not required, and the data collector is used exclusively as an "electronic field book." These electronic files are usually sufficient for submittal without identical hand entries from a field book. However, some Districts may require that a duplicate written field book be kept for electronically recorded data--for data safeguarding and legal issues. When duplicate field books are kept of electronically recorded data, the entries are compared to the files generated by the data collection processing. All field book data are written in the format set by each District. There is no Corps standard for field book data formats. Sample field book indexing and recording formats are shown in Chapter 12.

a. Four types of manual field book notes are kept in practice:

- sketches,
- tabulations,
- descriptions, and
- combinations of these.

The most common type is a combination form, but an experienced recorder selects the version best fitted to the job at hand. The location of a reference point may be difficult to identify without a sketch, but often a few lines of description are enough. Benchmarks are also described. In note keeping this axiom is always pertinent: when in doubt about the need for any information, include it and make a sketch. It is better to have too much data than not enough.

b. Topographic locations are numbered according to data record numbers (or feature codes), be they manually or electronically recorded. These feature codes depict what type of location and where locations were measured. This helps office personnel import digital field drawings into final design drawings. More important, blunders and mislabeled feature codes may be caught before costly design

errors are made. The finished map and the sketch should be similar. Sketches are not required to be at any scale. The suggestions listed below will help eliminate some common mistakes in manually recording field notes in a survey book (or optionally on an equivalent digital tablet device):

- Letter the notebook owner's name and address on the cover and first inside page.
- Title, index, and cross-reference each new job or continuation of a previous one.
- Sign surname and initials in the lower right-hand corner of the right page on all original notes.
- Use a hard pencil or pen, legible and dark enough to copy.
- Begin a new day's work on a new page.
- Immediately after a measurement, always record it directly in the field book rather than on a sheet of scrap paper for copying it.
- Do not erase recorded data.
- Use sketches instead of tabulations when in doubt.
- Avoid crowding.

c. Some features are often too complex to be fully detailed in a data collector; thus, a field book sketch is required. Figure 7-1 is such an example of a sketch that depicts details for a steam utility system that would be impractical to input in a digital data collector. The general orientation of the object would be captured in the data collector, and the points referenced on the sketch. A note should be entered into the data collector referencing additional attribute data is provided in the field book (including page number).

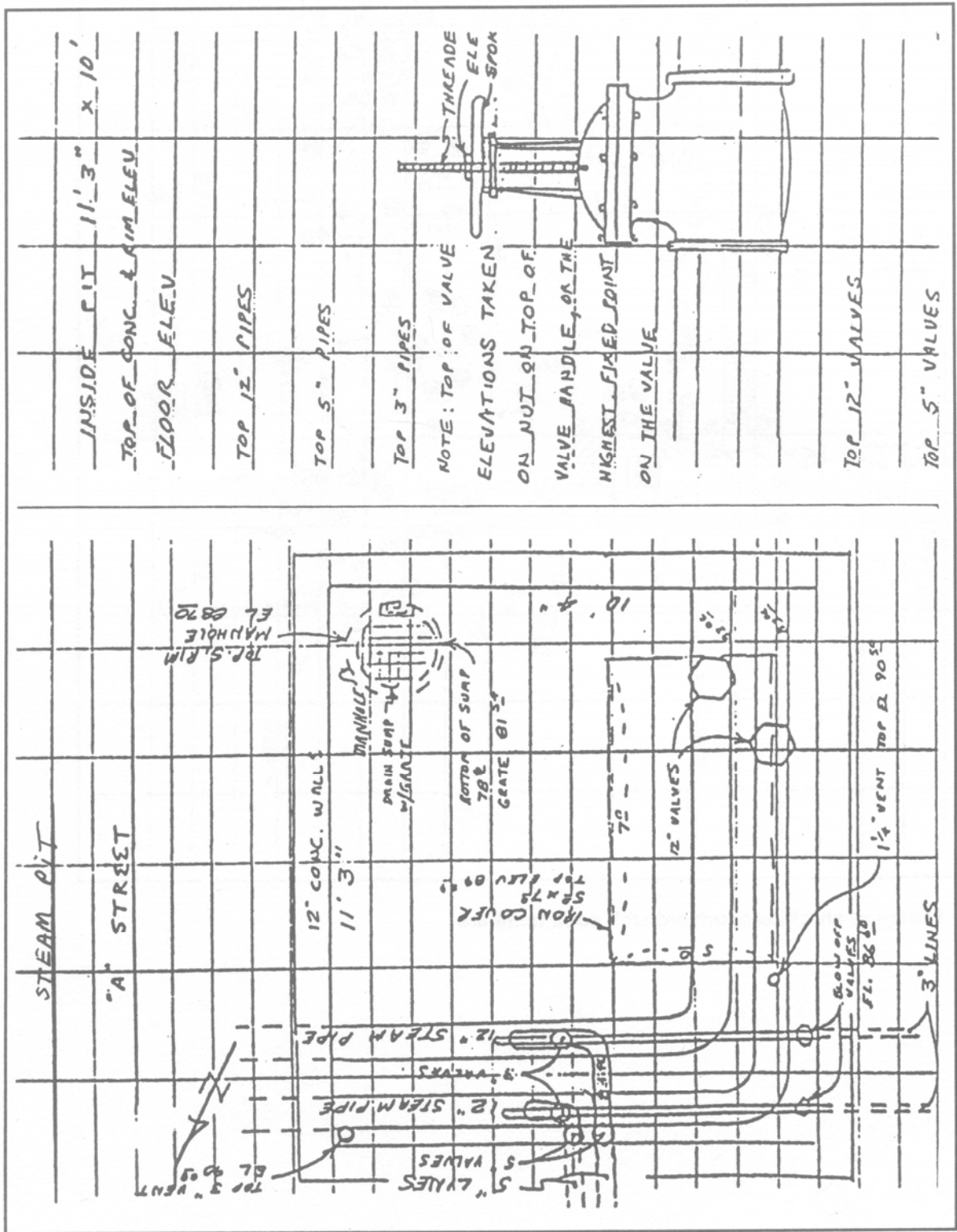

Figure 7-1. Sample from field book depicting utility details

7-3. Functional Requirements of a Generic Data Collector

A well-functioning and efficient data collector is vital to performing detail surveys using a total station or RTK system. Assumptions or oversights made at the time of equipment purchase can force a survey operation into equipment problems on the job for the economic life of the equipment. Listed below are some options to consider when purchasing a field data collector:

- Weatherproof, designed for rugged/durable field use.
- Nonvolatile memory ensures data safety.
- Allow the storage of at least 5,000 or more points, including full descriptor and attribute information.
- Full search and edit routines immediately on the spot.
- Optional screen view of mapped data points.
- Compatibility with a variety of electronic total stations, digital levels, and/or GPS systems.
- Formatting must be very flexible for manual entry, even for various CADD leveling tasks.
- Capability to use two files in the collector: one file for collection, the other file for processed data for stakeout tasks.
- Data collector must communicate with and remotely operate the total station.
- All the features of the total station should be usable with the data collector purchased.
- The data collector must be compatible with the software.
- The data collector must be compatible with the data dictionary.

In evaluating a data collector system for purchase, the following questions should be asked:

- Can I view and store coordinates in the electronic data collector in the field?
- Is the data collector environmentally rugged? What are the environmental limitations of the hardware?
- Can I upgrade the data collector to the latest software version easily and inexpensively?
- Can I create control jobs that can be accessed from any routine in the data collector?
- What data in the data collector will I be able to edit in the field and how will that affect my raw data?
- Will the data collector be compatible with all of the total stations I own?
- Do I have a choice of output formats in the data collector?
- What level of training and support is offered at the time of purchase, and what level can I expect after I have had the data collector long enough to know what questions to ask?
- What type of feature coding and attribute capability does the data collector have?
- Can I set up the parameters and configurations in the data collector to the way I like to survey?
- What numbers of electronic devices, total stations, etc., are supported in the basic configuration?
- What types of data are supported? (raw data, coordinate data point list, roadway alignment, archive data files, and descriptions)
- Can I perform separate tasks for collection of traverse points vs. topographic features or side shots?
- Supports State Plane Coordinate input?
- Memory capacity?
- Is the collection of raw data the same as indicated on the survey instrument? (PPM & Prism Constant)
- Is the unit capable of utilizing data from two different coordinate files at the same time?
- Supports auto mapping?

- Supports North and South Azimuth References?
- Supports user definable parameters? (Angle/distance tolerances, observation sequence for direct and reverse observations)
 - Capable of producing stakeout reports, cut/fill, relative to design elevation?
 - Generate location of next stakeout point from rodman's positions?
 - Supports stakeout of a line?
 - Downloading/uploading capability? Can it be done remotely via modem?
 - Data collection software or data collector itself should output the following:
 - Point number
 - Coordinates
 - Elevations
 - Feature code

7-4. General Software Features on a Data Collector

Field data collectors are either self-contained within a total station or external units attached by cable or wireless (Bluetooth) connection to the survey instrument. Some of the more salient software features found on a data collector are outlined below, as taken from POB 2004b. Not all data collectors must contain all these software features to be acceptable--many of these features may not be required for standard Corps work. In addition, the more features that are included, the higher the cost of the data collector.

a. Cost. The average data collector software package will cost some \$1,500 to \$2,000; however software packages are available as low as \$150 and over \$3,000 at the high end. (These costs do not include the actual microprocessor hardware).

b. Computer. Some software packages will operate on a variety of operating systems while others are specific to a single system. The most common systems include CE.Net, CE, Microsoft, HP-48, and iPAQ. The newest systems have color display screens and will provide field-finish views of collected data. Screen displays should ideally include viewing of points, features, and associated attribute data entered during the survey.

c. Supported instruments. Data collector software may support only a specific brand of total station or can support (and connect with) a variety of electronic survey instruments, such as digital levels, static GPS, kinematic GPS, laser rangefinders, robotic total stations, etc. Obviously, software that encompasses all this versatility will cost more. The advantage of having a data collector that can perform many functions is obvious: the same instrument can be used with either a total station or GPS/RTK system.

d. Storage capacity. Most software can store almost an unlimited number of jobs and points, restricted only by the storage available in the data collector device.

e. Calculations. The software should be able to calculate coordinates from raw data observations, perform inverse computations, calculate intersections, perform traverse computations and adjustments, perform 2-point and 3-point resections (total stations), perform site calibrations (RTK), and perform area computations. Other desirable features would include a variety of stakeout options--to lines, curves, and slopes (including navigation to points), least-squares adjustments or regressions, volume and cut/fill computations, etc. Some of these COGO functions will be described later in this chapter.

f. Background images. The software should be able to import, orient, and display background images from a variety of file formats, such as MicroStation, AutoCAD, and ESRI, and display generic *.JPG, *.TIF, etc. type images.

7-5. Feature or Descriptor Codes for Topographic Field Data

Field codes or data collection codes are a means by which the surveyor controls the map compilation process. Feature codes for each shot are placed on the data collector. The code designations and sequencing will vary depending on the data collector and processing software. Typically, features are described in the data collector by means of some numeric or alphanumeric description. Strings of like features (e.g., curb lines, edges of roads, buildings) or polylines are identified by additional coding. Feature coding is an integral part of the field data acquisition phase. It defines characteristics of an object(s) and how they are represented on the final map--as points, lines, or areas. In addition, they can define the type of annotation, line weight, layer, or cell symbol to be placed on the map. Whether data are recorded by hand or electronically, one of the most critical survey operations is the recording of a code or description to properly identify the point during processing. For example, in a topographic or planimetric survey, identification of points which locate the position of curbs, gutters, centerlines, manholes, and other similar features are essential for their correct plotting and contour interpolation. Since the field crew can virtually produce the map from the field data, this eliminates the need for many field book sketches.

a. Feature code library. The coding scheme is designed so the computer can interpret the recorded data without ambiguity to create a virtually finished product. Normally a feature or descriptor code "library" is established for a given project. This library consists of the common object features that will be shot. During the survey, these feature/descriptor codes can be called up in the data collector after each shot, as a quality control check. If additional attribute information is needed on a point, this can be typed into the controller. These feature/descriptor codes associated with each topographic point shot are later downloaded to a CADD and/or GIS system. If additional attribute detail is provided, this information will stay with that point in the CADD/GIS system.

b. Typical descriptors used in a library. Currently, there is no established descriptor code standard for topographic features. Either numerical point codes or alphanumeric point feature codes can be entered into the data collector. Each District either has their own feature library standard, or accepts data in whatever format a contractor submits it in. Some projects are unique, and new descriptor codes are developed for that work. This variability may entail additional effort during subsequent inputs of datasets into CADD packages. The following is a partial list of alphabetic descriptor names for common features. These same features will have various descriptors in different Districts, as will be illustrated in subsequent lists. Whenever districts require specialized point codes, then the attribute file may be edited to include these changes.

Table 7-1. Typical Descriptors used in a Feature Library

1X2 STAKE	DOLPHIN	MONITORING	SPRINKLER
2X2 HUB/TACK	DOWN GUY	DEVICE	CONTROL VALVE
A/G FUEL TANK	DRAIN	NAIL	STEAM MH
A/G STEAM LINE	DRAIN PIT	NGS MON	STEAM PIT
A/G WATER VALVE	DRIVEWAY	O/H COMM	STEEL GUARD
AC@PCC JOINT	EDGE ROAD	O/H PIPE	POST
AIR RELIEF VALVE	EDGE ROAD	O/H POWER LINE	STEPS
AIRCRAFT TIE-DOWN	ELECTRICAL	ORNAMENTAL	STORM
ALUM MON	ELECTRICAL MH	PAD	STORM MH
ARCH CREST	ELECTRICAL	PAINT STRIPE	SWITCH BOX
ARCH END	OUTLET	PBM	TBM
ARCH START	ELECTRICAL	PHONE BOOTH	TELE @ BLDG
ARCH TOE	SPLICE	PICTURE POINT	TELE SPLICE BOX
ASPHALT	ELECTRICAL VAULT	PIER TOE	TELEPHONE MH
ASPHALT PATCH	END OF BRIDGE	PIER TOP	TELEPHONE POLE
B/L	EXPANSION JOINT	PILING	TEST WELL
BARBED WIRE	EXPOSED SEWER	PIPE	TOE
BENCHMARK	PIPE	PK NAIL	TOE CONC DRAIN
BLDG CORNER	FILED X	PORCH	TROUGH
BOLT	FILLER PIPE U/G	POWER @ BLDG	TOE/RIPRAP
BRASS CAP	TANK	POWER POLE	TOP
BREAKER BOX	FIRE ALARM	POWER	TOP CONC DRAIN
BREAKLINE	FIRE HYDRANT	POLE/TRANS	TROUGH
BREAKLINES	FLOODWALL	PVC PIEZOMETER	TOP OF RAIL
BRIDGES	FLOW DITCH	PVC SLOPE	TOP STRUCTURE
BUILDING LINE	FUEL	INDICATOR	TOP/RIPRAP
BUOY	FUEL PIT	QUARTER CORNER	TOPOGRAPHIC
C/L	FUEL TANK VENT	RAMP	TOWER LEG
C/L ROAD	PIPE	REBAR	TRAFFIC SIG
C/L ROAD	GAS	REBAR/CAP	CONTROL BOX
C/L RR TRACK	GAS LINE	REFERENCE POINT	TRANSFORMER
CABLE TV	GAS METER	RETAINING WALL	TREE LINE
CATCH BASIN	GAS PAINT MARK	RISER	U/G CABLE MARKER
CDHD	GAS VALVE	ROAD WORK	U/G COMM
CDHU	GEOTECH	ROCK	U/G COMM BOX
CHAIN LINK	GPS MON	RR SPIKE	U/G CONDUIT
CHISELED X	GRATED STORM MH	RWY LIGHT	U/G STREET
CLOSING CORNER	GROUND SHOT	SANITARY	LIGHTING BOX
COE MON	GROUNDING ROD	SANITARY	USGS MON
COMMUNICATION	GUY POLE	CLEANOUT	WATER
CONC MON	HAND DRILL HOLE	SANITARY LINE	WATER LINE
CONC. PATCH	HAZARDOUS	SANITARY MH	WATER METER
CONIFEROUS	WASTE VAULT	SECTION CORNER	WATER MH
CONTROL	HEADWALL	SHOULDER ROAD	WATER STANDPIPE
CROWN	HEATING	SIDEWALK	WATER VALVE
CULVERT	HOMESTEAD	SIGN	WE/WS
CURB	CORNER	SIXTEENTH	WELL HEAD
CURTAIN DRAIN	HYDRO	CORNER	WITNESS CORNER
CUT-OFF FENCE	LIGHT POLE	SLOPE	WOOD FENCE
POST	MEANDER CORNER	SLOPE BREAK	WOOD GUARD
DECIDUOUS	MON	SOUNDING	POST

c. *Project specific descriptors.* Individual projects will often have unique repeating features, necessitating additional feature codes. An example of a field feature coding scheme for a specific hydraulic design project in Tulsa District is shown below:

B = BEGIN	TB = TOP BANK
E = END	FL = FLOW LINE
BK = BREAK	H WALL = HEAD WALL
RIP = RR = RIP RAP	FEN = FENCE
ISL = ISLAND	RP = REFERENCE POINT
BEED = CHANNEL BED	G PT = GUARD RAIL POST
CHBS = CHECK BACKSIGHT	SC A = SCOUR AREA
CON = CONCRETE	BNK = BANK
CP = CONTROL POINT	

d. *Creating unique descriptor codes.* This is done in the software provided with or accompanying the data collector. Alphanumeric codes may also be used for a specific feature. The following process is excerpted from TDS 1999 and is typical of basic feature coding options that are used in most data collectors today.

TDS-HP48GX DESCRIPTOR CODE TABLES

One of the best ways of improving the productivity of data collecting is to speed up the process of keying in point descriptors. The Descriptor Code Table is provided for this purpose. Basically, the Descriptor Code Table is a text file in the TDS-48GX that contains a list of commonly-used point descriptors.

The descriptor table is a list of codes or abbreviations that are associated with a descriptor. These codes may be keyed into the descriptor field in place of the full descriptor. When one of these codes is found in a descriptor field, the TDS-48GX will replace the code with its associated descriptor. Once the TDS-48GX user has established a Code Table of commonly used descriptors, whenever the descriptor prompt appears in the TDS-48 program, a code may be keyed in. The TDS-48 will insert the complete descriptor from the code table in the place of the code in the Coordinate and Raw Data files.

The Code Table is actually a special text file in the TDS-48. It requires the unique name "DESCRIPT.TXT." The Code Table itself is composed of a series of lines of text. Each line of text consists of the code followed by a single space and the full descriptor. An example of a Code Table would appear as:

1	POB
02	HUB
CB	CURB
T4	OAK TREE
POB	PT. OF BEGINNING
F	FENCE
f	FENCE

Codes may be up to seven characters in length and may consist of any alphanumeric characters. Examples of these are: 02, CB, and T4. The code is case sensitive, which means that the "F" and "f" codes are not the same and could have different descriptors. If you want an upper or lower case "F" to be interpreted as FENCE you need to enter it twice (as above). The code and the descriptor are separated by one space, and the remainder of the line is the descriptor that is linked to this code. The descriptor may contain alphanumeric characters, spaces, punctuation or symbols; basically anything that can be typed into a descriptor from the keyboard.

During a survey, when the TDS-48 requests a descriptor (usually after the total station has taken a shot), you may key in the full descriptor such as CURB; or you may key in the corresponding code, such as CB, as a "shorthand" notation to indicate the CURB. In either case, the full descriptor CURB will be stored in the job file. If the data is being collected manually, the code may be keyed into the descriptor line of the Traverse/Sideshot Screen before the [TRAV] or [SIDES] softkeys are pressed. As stated above, the TDS-48 will store the full descriptor from the table into the job file, not the code.

Using Codes With Keyed In Descriptors And Combining Codes

Often you want to use a descriptor from the Code Table, but you would like to add additional characters to the descriptor from the keyboard. As an example, suppose you wanted to use the descriptors "NE 1/4 CORNER" and "SE 1/4 CORNER." Assume that the descriptor "1/4 CORNER" has been keyed into a Code Table under the code "15." To combine text and codes from the Code Table, use the "+" key in the following way: When the descriptor prompt appears in the display and you want the descriptor to read "NE 1/4 CORNER," key in "NE+15." The TDS-48 will combine the keyed-in descriptor "NE" with the descriptor associated with code 15 to create the complete descriptor "NE 1/4 CORNER."

Codes may also be concatenated with keyed in descriptors. For example, if you wanted a series of points with descriptors TOP OF CURB A1, TOP OF CURB A2, TOP OF CURB A3, etc., you would setup TOP OF CURB in a Descriptor Code Table with code 23, for example. Then in response to the descriptor prompt, key in 23+A1, 23+A2, 23+A3, etc.

Codes may also be concatenated with other codes. Assume you have code descriptor pairs for: T TREE, T1 PINE, T2 OAK and T3 MAPLE. The result of the following entries: T1+T; T2+T; T3+T; would be: PINE TREE; OAK TREE and MAPLE TREE. This technique may be used to concatenate up to three descriptor codes or text segments.

7-6. Descriptor Codes and Level Assignments for Various Topographic Features

The following listing contains an example of standardized coding for various features encountered on USACE civil and military projects. Both an alpha and numeric code are given. The four-digit “#Code” corresponds to the level number assignment, the first two digits representing the level (or first digit when only 3 digits are shown).

	Description	Alpha Code	# Code	Elevation	Main Feature/Level Designation
1	BUILDING	BLDG	401	Random	Buildings
2		BUILDING			
3	HOUSE	HOUSE	402	DNC	Buildings
4	TRAILER	TRAILER	403	DNC	Buildings
5	GARAGE	GARAGE	404	DNC	Buildings
6	SHED	SHED	405	Breakline	Buildings
7	CABIN	CABIN	411	DNC	Buildings
8	PORCH	PORCH	412	Exterior	Buildings
9	STEPS	STEPS	413	Breakline	Buildings
10	OVERHANG	OVERHANG	414	DNC	Buildings
11	CL ROAD	CLRD	601	Breakline	Centerline
12		ROADCL			
13		CLROAD			
14	CL BRIDGE	CLBDG	602	Breakline	Centerline
15		BRIDGECL			
16		CLBRIDGE			
17	CL RAILROAD	CLRR	603	Random	Centerline
18		CLRAILROAD			
19		RAILROADCL			
20	CL ABANDONED RAILROAD	CLARR	604	Breakline	Centerline
21	CL DITCH	DITCHCL	605	Breakline	Centerline
22		CLDITCH			
23	CL CREEK	CLCRK	606	Breakline	Centerline
24		CLD			
25		CREEKCL			
26		CLCREEK			
27	CENTERLINE	CENTLINE	607	Breakline	Centerline
28		CLINE			
29	CL SWALE	CLSWALE	608	Breakline	Centerline
30		CLSWL			
31	CL BERM	CLBERM	609	Breakline	Centerline
32	CL WALL	CLWALL	610	DNC	Centerline
33	CL STONE WALL	CLSTWALL	611	DNC	Centerline
34		STWALLCL			
35	CL DIKE	CLDIKE	612	Breakline	Centerline
36		DIKECL			
37	EDGE DRIVEWAY	DRIVEWAY	801	Breakline	Roads, Parking Lots, Walks, Railroads, and Trails
38		EDGEDRIVEWAY			
39	EDGE PAVEMENT	PVMTEDGE	802	Breakline	Roads, Parking Lots, Walks, Railroads, and Trails
40	EDGE ROAD	EDGEROAD	803	Breakline	Roads, Parking Lots, Walks, Railroads, and Trails
41		ROADEDGE			
42	EDGE SHOULDER	EDGESHOULDER	804	Breakline	Roads, Parking Lots, Walks, Railroads, and Trails
43		SHOULDEREDGE			

44	EDGE SIDEWALK	ESW	805	Breakline	Roads, Parking Lots, Walks, Railroads, and Trails
45		ESWALK			
46		EWALK			
47		SW			
48	EDGE TRAIL	EDGETRAIL	806	Breakline	Roads, Parking Lots, Walks, Railroads, and Trails
49		TRAILEDGE			
50	BRIDGE CORNER	BRIDGECOR	807	Breakline	Roads, Parking Lots, Walks, Railroads, and Trails
51		CORBRIDGE			
52	PIER TOP	PIERTOP	808	DNC	Roads, Parking Lots, Walks, Railroads, and Trails
53		TOPPIER			
54	PIER TOE	PIERTOIE	809	DNC	Roads, Parking Lots, Walks, Railroads, and Trails
55		TOEPIER			
56	RAILROAD SWITCH	RRSW	851	DNC	Roads, Parking Lots, Walks, Railroads, and Trails
57	CONCRETE EDGE	CONCEDGE	901	Breakline	Concrete Joint Layout
58		EDGECONC			
59	EXPANSION JOINT	CONCJOINT	902	Breakline	Concrete Joint Layout
60		EXPANJOINT			
61	CURB TOP BACK	BC	903	Breakline	Concrete Joint Layout
62		LBC			
63		CURBTB			
64		TBCURB			
65	CURB FRONT EDGE	CURBFE	904	Breakline	Concrete Joint Layout
66	CURB FLOW LINE	CURBFL	905	Breakline	Concrete Joint Layout
67	CURB/PAVEMENT	CURBPVMT	906	Breakline	Concrete Joint Layout
68	CURB-CUT	CURBCUT	907	Random	Concrete Joint Layout
69	CONCRETE	CONCRETE	1001	Random	Concrete Joint Elevations
70	HIGHWAY SIGN	HIGHWAYSIGN	1301	Random	Pavement Markings and Signs
71	SPEED SIGN	SPEEDSIGN	1302	Random	Pavement Markings and Signs
72	STOP SIGN	STOPSIGN	1303	Random	Pavement Markings and Signs
73	YIELD SIGN	YIELDSIGN	1304	Random	Pavement Markings and Signs
74	TURN SIGN	TURNSIGN	1305	Random	Pavement Markings and Signs
75	STOP AHEAD SIGN	STOPAHEADSIG N	1306	Random	Pavement Markings and Signs
76	STREET SIGN	STREETSIGN	1307	Random	Pavement Markings and Signs
77	CURVE SIGN	CURVESIGN	1308	Random	Pavement Markings and Signs
78	BRIDGE SIGN	BRIDGESIGN	1309	Random	Pavement Markings and Signs
79	MILE MARKER	MILEMARKER	1310	Random	Pavement Markings and Signs
80	REFLECTOR	REFLECTOR	1311	Random	Pavement Markings and Signs
81	SIGN	SIGN	1312	DNC	Pavement Markings and Signs
82	WEIGHT LIMIT SIGN	WEIGHTLIMITSIG N	1313	Random	Pavement Markings and Signs
83	RR X-ING SIGN	RRXINGSIGN	1317	Random	Pavement Markings and Signs
84	RR SIGN	RRSIGN	1318	Random	Pavement Markings and Signs
85	BILLBOARD	BBOARD	1319	DNC	Pavement Markings and Signs
86		BILLBRD			
87	DIST-TO-GO	DISTTOGO	1321	Random	Pavement Markings and Signs
88	PAINT STRIPE	PAINTSTRIPE	1322	Random	Pavement Markings and Signs
89	PARKING METER	PARK	1323	DNC	Pavement Markings and Signs
90	MAIL BOX U.S.	USMAILBOX	1394	DNC	Pavement Markings and Signs
91		MAILBOXUS			
92	RESIDENT SIGN	RESIDENTSIGN	1395	Random	Pavement Markings and Signs
93	MAIL BOX RESIDENTIAL	RESMAILBOX	1398	Random	Pavement Markings and Signs

EM 1110-1-1005
1 Jan 07

94		MAILBOXRES			
95	FLAG POLE	FPOLE	1399	Random	Pavement Markings and Signs
96		FLAGPOLE			
97	WALL TOP EDGE	WALLTOPEDGE	1401	Breakline	Structures and Headwalls
98	WALL BOTTOM	BOTWALL	1402	Breakline	Structures and Headwalls
99		WALLBOT			
100	PUMP	PUMP	1403	Breakline	Structures and Headwalls
101	FLOODGATE	FLOODGATE	1404	Breakline	Structures and Headwalls
102	STEEL GUARD POST	STEELPOST	1470	Breakline	Structures and Headwalls
103	WOOD GUARD POST	WOODPOST	1471	Breakline	Structures and Headwalls
104	POST	POST	1472	Random	Structures and Headwalls
105	CORRUGATED STEEL-FLOW LINE	CMP	1601	DNC	Culverts
106	REINFORCED CONCRETE-FLOW LINE	RCP	1602	DNC	Culverts
107	PVC-FLOW LINE	PVCFL	1603	DNC	Culverts
108	TOP CULVERT-BASE FILL	TOPCULBASFIL	1604	DNC	Culverts
109	BOX-FLOW LINE	BOXFL	1605	DNC	Culverts
110	TOP OF PIPE CULVERT	TOPCULVERT	1606	Breakline	Culverts
111	RIPRAP	RIPRAP	1801	Random	Riprap
112	RIPRAP TOP	RRAPTOP	1802	Breakline	Riprap
113		TOPRRAP			
114	RIPRAP TOE	RRAPTOE	1803	Breakline	Riprap
115		TOERRAP			
116	WATER EDGE	WE	1901	Breakline	Water Features
117	THALWEG	THALWEG	1902	Breakline	Water Features
118	BED	BED	1903	Random	Water Features
119	TREE-DEC	CYPRESS TREE	2101	DNC	Vegetation
120		DOGWOOD			
121		DTREE			
122		MAPLE			
123		OAK			
124	TREE-CON	CTREE	2102	DNC	Vegetation
125		FERN			
126		PINE			
127		SPRUCE			
128	TREE	TREE	2103	DNC	Vegetation
129	TREE LINE	TL	2104	DNC	Vegetation
130	STUMP	STUMP	2105	DNC	Vegetation
131	GROUND IN TIMBER	INTREES	2106	Random	Vegetation
132	SHRUB	SHRUB	2107	Random	Vegetation
133	SHRUB LINE	SHRUBLINE	2108	Random	Vegetation
134	BRUSH	BRUSH	2109	Random	Vegetation
135	BRUSH LINE	BRUSHLINE	2110	Random	Vegetation
136	CULTIVATION	CULT	2111	Random	Vegetation
137	LAWN EDGE	LAWNEDGE	2112	Breakline	Vegetation
138		EDGELAWN			
139	BARBED WIRE FENCE	BWFENCE	2301	Random	Fences, Guard Rails
140		FENCEBW			
141	CHAIN LINK FENCE	CLFENCE	2302	Random	Fences, Guard Rails
142		FENCECL			
143	WOOD FENCE	WFC	2303	Random	Fences, Guard Rails
144	STOCK FENCE	STOCKFEN	2304	Random	Fences, Guard Rails
145		FENCESTK			
146	GATE EDGE	GATE	2305	Random	Fences, Guard Rails
147		GATEEDGE			

148		EDGE GATE			
149	FENCE CORNER	CORFENCE	2306	Random	Fences, Guard Rails
150		FENCECOR			
151	GUARDRAIL	GRAIL	2308	Random	Fences, Guard Rails
152	CATTLE GUARD	CATGUARD	2309	Random	Fences, Guard Rails
153	PROPERTY PIN	PPIN	2501	DNC	Boundary Lines / Cadastral-R/W
154		PROPPIN			
155	BLOCK CORNER	BLOCKCOR	2502	DNC	Boundary Lines / Cadastral-R/W
156	PLSS CORNER	SECCOR	2503	DNC	Boundary Lines / Cadastral-R/W
157	R/W-CAP	RWCAP	2509	DNC	Boundary Lines / Cadastral-R/W
158	R/W-MON	RWMON	2510	DNC	Boundary Lines / Cadastral-R/W
159	R/W-PIN	RWPIN	2511	DNC	Boundary Lines / Cadastral-R/W
160	R/W-REBAR	RWREBAR	2512	DNC	Boundary Lines / Cadastral-R/W
161	STATION MARKER	STAMARKER	2513	DNC	Boundary Lines / Cadastral-R/W
162	CONTROL HORIZ	HCON	2701	Breakline	Survey Control Points, Baselines
163	CONTROL VERT	BM	2702	DNC	Survey Control Points, Baselines
164		VCON			
165	CONTROL H/V	HVCON	2703	DNC	Survey Control Points, Baselines
166	GAUGE	GAUGE	2704	DNC	Survey Control Points, Baselines
167	CONTROL SECONDARY	SECCON	2705	DNC	Survey Control Points, Baselines
168		CONSEC			
169	BASELINE	BASELINE	2706	DNC	Survey Control Points, Baselines
170	PHOTO HORIZ	PHOTOH	2707	DNC	Survey Control Points, Baselines
171		HPHOTO			
172	PHOTO VERT	PHOTOV	2708	DNC	Survey Control Points, Baselines
173		VPHOTO			
174	PHOTO H/V	PHOTOHV	2709	DNC	Survey Control Points, Baselines
175		HVPHOTO			
176	BS STATION	BSSTATION	2710	DNC	Survey Control Points, Baselines
177	INST STATION	INSTSTATION	2711	DNC	Survey Control Points, Baselines
178	FS STATION	FSSTATION	2712	DNC	Survey Control Points, Baselines
179	CONTROL CHECK	CONCHECK	2713	DNC	Survey Control Points, Baselines
180	ELEVATION CHECK	ELEVCHECK	2714	DNC	Survey Control Points, Baselines
181	DUNE TOP	TOPDUNE	2903	Breakline	Breaklines
182		DUNETOP			
183	DUNE TOE	BOTDUNE	2904	Breakline	Breaklines
184		TOEDUNE			
185		DUNETOE			
186	BANK TOP	TB	2905	Breakline	Breaklines
187		BANKTOP			
188		TOPBANK			
189	BANK TOE	BB	2906	Breakline	Breaklines
190		BOTBANK			
191		TOEBANK			
192		BANKTOE			
193	CUT TOP	CUTTOP	2907	Breakline	Breaklines
194		TOPCUT			
195	CUT TOE	CUTTOE	2908	Breakline	Breaklines
196		TOECUT			
197		BOTCUT			
198	FILL TOP	TOPFILL	2909	Breakline	Breaklines
199		FILLTOP			
200	FILL TOE	BOTFILL	2910	Breakline	Breaklines
201		TOEFILL			
202		FILLTOE			
203	BREAK TOP	BREAKTOP	2911	Breakline	Breaklines
204		TOPBREAK			

EM 1110-1-1005
1 Jan 07

205	BREAK TOE	BREAKTOE	2912	Breakline	Breaklines
206		TOEBREAK			
207	SWALE TOP	SWALETOP	2913	Breakline	Breaklines
208		TOPSWALE			
209	SWALE TOE	SWALETOE	2914	Breakline	Breaklines
210		TOESWALE			
211	RAILROAD BALLAST TOP	TRRBAL	2915	Breakline	Breaklines
212	RAILROAD BALLAST TOE	BRRB	2916	Breakline	Breaklines
213	BREAK LINE	BRK	2999	Breakline	Breaklines
214		BRKLINE			
215	GROUND	GND	3001	Random	Spot Elevation
216		NG			
217		SPOT			
218		SUR			
219		GROUND			
220	SLOPE	SLOPE	3002	Random	Spot Elevation
221		SLP			
222	GRAVEL	GRAVEL	3003	Random	Spot Elevation
223	SAND	SAND	3004	Random	Spot Elevation
224	LAWN	LAWN	3005	Random	Spot Elevation
225		GRASS			
226	PAVEMENT	PVMT	3006	Random	Spot Elevation
227		PAVEMENT			
228	ROCK	ROCK	3007	Random	Spot Elevation
229	SHOULDER	SHOULDER	3009	Random	Spot Elevation
230	BORE HOLE	BORE	3401	DNC	Bores, Holes, and Text
231		BOREHOLE			
232	TEST PIT	TPIT	3402	DNC	Bores, Holes, and Text
233		TESTPIT			
234	PERC TEST	PERCTEST	3403	DNC	Bores, Holes, and Text
235	STAND PIPE	STANDPIPE	3404	DNC	Bores, Holes, and Text
236	CDHD	CDHD	3405	DNC	Bores, Holes, and Text
237	CDHU	CDHU	3406	DNC	Bores, Holes, and Text
238	MONITORING DEVICE	MONDEVICE	3407	DNC	Bores, Holes, and Text
239	PVC PIEZOMETER	PVCPIEZ	3408	DNC	Bores, Holes, and Text
240	PVC SLOPE INDICATOR	PVCSLPIN	3409	DNC	Bores, Holes, and Text
241	TEST WELL	TESTWELL	3410	DNC	Bores, Holes, and Text
242	WELL HEAD	WELLHEAD	3411	DNC	Bores, Holes, and Text
243	CONC DRAIN TROUGH TOP	CONCDTTOP	3501	Breakline	Storm Sewerlines and Manholes
244		TOPCONCDT			
245	CONC DRAIN TROUGH TOE	CONCDTTOE	3502	Breakline	Storm Sewerlines and Manholes
246		TOECONCDT			
247	GRADED STORM MH	GRSTMH	3503	DNC	Storm Sewerlines and Manholes
248	STORM MH	SDRMH	3504	DNC	Storm Sewerlines and Manholes
249		STORMMH			
250		MHSTORM			
251	CATCH BASIN	CB	3505	Random	Storm Sewerlines and Manholes
252		EDGEGB			
253	DRAIN PIT	DRAINPIT	3506	DNC	Storm Sewerlines and Manholes
254	CURTAIN DRAIN	CURTAINDRN	3509	DNC	Storm Sewerlines and Manholes
255	FLOW LINE IN STORM	FLISTORM	3510	DNC	Storm Sewerlines and Manholes
256	FLOW LINE OUT STORM	FLOSTORM	3511	DNC	Storm Sewerlines and Manholes
257	TOP OF PIPE STORM	TOPSTORM	3512	DNC	Storm Sewerlines and Manholes

258	SANITARY MH	SSMH	3701	DNC	Sanitary Sewerlines, and Manholes
259		SANMH			
260		MHSAN			
261	FLOW LINE IN SEWER	FLISEWER	3702	DNC	Sanitary Sewerlines, and Manholes
262	FLOW LINE OUT SEWER	FLOSEWER	3703	DNC	Sanitary Sewerlines, and Manholes
263	TOP OF PIPE SEWER	TOPSEWER	3704	DNC	Sanitary Sewerlines, and Manholes
264	SANITARY LINE	SSLINE	3706	DNC	Sanitary Sewerlines, and Manholes
265	CLEAN OUT	CLEANOUT	3707	DNC	Sanitary Sewerlines, and Manholes
266	LIFT STATION	LIFTSTA	3708	DNC	Sanitary Sewerlines, and Manholes
267	LEACH LINE	LEACHLINE	3709	DNC	Sanitary Sewerlines, and Manholes
268	SEPTIC TANK	SEPTICTANK	3710	DNC	Sanitary Sewerlines, and Manholes
269	DRYWELL	DRYWELL	3711	DNC	Sanitary Sewerlines, and Manholes
270	DRAIN FIELD	DRAINFIELD	3712	DNC	Sanitary Sewerlines, and Manholes
271	SANITARY SEWER FORCE MAIN	SSMAIN	3713	DNC	Sanitary Sewerlines, and Manholes
272	WATER VALVE	WATERVALVE	3901	DNC	Water Lines, Fire Hydrants, and Water Tanks
273	AIR RELIEF VALVE	AIRVALVE	3902	DNC	Water Lines, Fire Hydrants, and Water Tanks
274	RISER	RISER	3903	DNC	Water Lines, Fire Hydrants, and Water Tanks
275	WATER MH	WATERMH	3904	Random	Water Lines, Fire Hydrants, and Water Tanks
276		MHWATER			
277	WELL	WELL	3905	Random	Water Lines, Fire Hydrants, and Water Tanks
278	WATER LINE	WATERLINE	3906	Random	Water Lines, Fire Hydrants, and Water Tanks
279	WELL HOUSE	WELLHOUSE	3907	Random	Water Lines, Fire Hydrants, and Water Tanks
280	FIRE HYDRANT	FH	3908	Random	Water Lines, Fire Hydrants, and Water Tanks
281		HYD			
282	WATER METER	WATERMETER	3909	DNC	Water Lines, Fire Hydrants, and Water Tanks
283	END ABUTMENT	ENDABUT	3910	DNC	Water Lines, Fire Hydrants, and Water Tanks
284	WATER SERVICE	WATERSER	3911	DNC	Water Lines, Fire Hydrants, and Water Tanks
285	CURB STOP	CURBSTOP	3912	DNC	Water Lines, Fire Hydrants, and Water Tanks
286	SPRINKLER HEAD	SPKLR	3913	Random	Water Lines, Fire Hydrants, and Water Tanks
287	PUMP	WATERPUMP	3915	Random	Water Lines, Fire Hydrants, and Water Tanks
288	GAS VALVE	GASV	4102	DNC	Gaslines, Features, and Valves
289		GVALVE			
290		GASVALVE			
291	GAS TANK	GASTANK	4103	DNC	Gaslines, Features, and Valves
292	GAS METER	GASM	4104	DNC	Gaslines, Features, and Valves
293	GAS LINE	GASL	4105	DNC	Gaslines, Features, and Valves
294		GASLINE			
295	GAS MH	GASMH	4106	Breakline	Gaslines, Features, and Valves
296		MHGAS			
297	GAS WITNESS POST	GASWITPOST	4107	Random	Gaslines, Features, and Valves
298	FUEL PUMP	FUELPUMP	4109	DNC	Gaslines, Features, and Valves
299	FILLER PIPE U/G TANK	FILLPIPEUGTAN K	4110	Random	Gaslines, Features, and Valves
300	A/G FUEL TANK	AGFUELTANK	4111	Random	Gaslines, Features, and Valves

EM 1110-1-1005
1 Jan 07

301	FUEL TANK PIPE VENT	FUELTANKPIPEVENT	4112	Random	Gaslines, Features, and Valves
302	FUEL PIT	FUELPIT	4113	DNC	Gaslines, Features, and Valves
303	POWER POLE	PPOLE	4301	DNC	Powerlines, Lights, and Telephone Poles
304	POWER DROP	PDROP	4302	DNC	Powerlines, Lights, and Telephone Poles
305	U/G POWER LINE	UGPOWER	4303	Random	Powerlines, Lights, and Telephone Poles
306		UNELEC			
307	O/H POWER LINE	OHE	4304	DNC	Powerlines, Lights, and Telephone Poles
308		OVEL			
309	LOW WIRE POWER	LOWWIREP	4305	Random	Powerlines, Lights, and Telephone Poles
310	LIGHT POLE	LP	4306	DNC	Powerlines, Lights, and Telephone Poles
311		LPOLE			
312	GUY POLE POWER	GUYPOLEEELEC	4307	Random	Powerlines, Lights, and Telephone Poles
313	GUY ANCHOR POWER	GUYPOWER	4308	Random	Powerlines, Lights, and Telephone Poles
314	TRANSFORMER	TRANSFOR	4309	DNC	Powerlines, Lights, and Telephone Poles
315	ELECTRIC MH	ELECMH	4310	Random	Powerlines, Lights, and Telephone Poles
316		EMH			
317		MHELEC			
318	SERVICE POLE	SERVPOLE	4311	Random	Powerlines, Lights, and Telephone Poles
319	ELECTRIC METER	ELECMETER	4312	DNC	Powerlines, Lights, and Telephone Poles
320	POWER PED	POWERPED	4313	Random	Powerlines, Lights, and Telephone Poles
321	ELECTRIC DUCT	ELECDUCT	4314	DNC	Powerlines, Lights, and Telephone Poles
322	YARD LIGHT	YARDLIGHT	4315	DNC	Powerlines, Lights, and Telephone Poles
323	ELECTRIC JUNCTION BOX	EBOX	4316	DNC	Powerlines, Lights, and Telephone Poles
324		ELECBOX			
325	TOWER LEG	TOWERLEG	4317	Random	Powerlines, Lights, and Telephone Poles
326	TRAFFIC LIGHT POLE	TLP	4318	DNC	Powerlines, Lights, and Telephone Poles
327	TRAFFIC LIGHT SIGNAL BOX	TLSB	4319	DNC	Powerlines, Lights, and Telephone Poles
328	FIRE ALARM	FIREALARM	4320	DNC	Powerlines, Lights, and Telephone Poles
329	RAILROAD SIGNAL POST	RRSIGPOST	4321	Random	Powerlines, Lights, and Telephone Poles
330	RAILROAD SIGNAL BOX	RRSIGBOX	4322	Random	Powerlines, Lights, and Telephone Poles
331	RUNWAY LIGHT	RUNWAYLIGHT	4323	Random	Powerlines, Lights, and Telephone Poles
332	THRESHOLD LIGHT	THRESLIGHT	4324	Random	Powerlines, Lights, and Telephone Poles
333	TELEPHONE POLE	TELEPOLE	4340	Random	Powerlines, Lights, and Telephone Poles
334	PHONE DROP	PHONEDROP	4341	Random	Powerlines, Lights, and Telephone Poles
335	U/G PHONE LINE	UGPHONE	4342	Random	Powerlines, Lights, and Telephone Poles
336		UNTEL			
337	O/H PHONE LINE	OVTEL	4343	DNC	Powerlines, Lights, and Telephone Poles
338		OHPHONE			
339	GUY POLE PHONE	GUYPOLEPHON E	4344	Random	Powerlines, Lights, and Telephone Poles
340	GUY ANCHOR PHONE	GUYPHONE	4345	Random	Powerlines, Lights, and Telephone Poles
341	TELEPHONE MH	TELMH	4346	DNC	Powerlines, Lights, and Telephone Poles
342	PHONE PED	PHONEPED	4347	DNC	Powerlines, Lights, and Telephone Poles
343	PHONE BOX	PHONEBOX	4348	DNC	Powerlines, Lights, and Telephone Poles
344	PHONE SUBSTATION	PHONESUB	4349	DNC	Powerlines, Lights, and Telephone Poles
345	PHONE BOOTH	TBOOTH	4350	DNC	Powerlines, Lights, and Telephone Poles
346	LOW WIRE PHONE	LWPHONE	4351	DNC	Powerlines, Lights, and Telephone Poles
347	REPEATER	REPEATER	4352	DNC	Powerlines, Lights, and Telephone Poles
348	U/G FIBER OPTIC	FIBERUG	4361	Random	Powerlines, Lights, and Telephone Poles
349		UGFIBER			
350	FIBER POST	FIBPOST	4362	Random	Powerlines, Lights, and Telephone Poles
351	U/G CABLE/FIBER MARKER	UGCAFBMKR	4363	Random	Powerlines, Lights, and Telephone Poles
352	U/G CABLE TV	TVUG	4371	Random	Powerlines, Lights, and Telephone Poles

353		UGTV			
354	O/H CABLE TV	OHTV	4372	Random	Powerlines, Lights, and Telephone Poles
355	TV PED	TVPED	4373	Random	Powerlines, Lights, and Telephone Poles
356	SATELLITE DISH	SATDISH	4374	DNC	Powerlines, Lights, and Telephone Poles
357	SATELLITE BOX	SATBOX	4375	DNC	Powerlines, Lights, and Telephone Poles
358	STEAM LINE	STEAMLINE	4501	DNC	Steamlines, Features, and Valves
359	STEAM LINE VALVE	SLVALVE	4502	DNC	Steamlines, Features, and Valves
360	STEAM MH	STEAMMH	4503	DNC	Steamlines, Features, and Valves
361		MHSTEAM			
362	STEAM PIT	STEAMPIT	4504	DNC	Steamlines, Features, and Valves
363	SOUNDING	SNDG	4901	Random	Soundings
364		SOUNDING			
365	BORROW PIT TOP	BORPITTOP	5001	Breakline	Channel Lines, Disposal Areas
366		TOPBORPIT			
367	BORROW PIT TOE	BORPITTOE	5002	Breakline	Channel Lines, Disposal Areas
368		TOEBORPIT			
369	SPOIL TOP	SPOILTOP	5003	Breakline	Channel Lines, Disposal Areas
370		TOPSPOIL			
371	SPOIL TOE	SPOILTOE	5004	Breakline	Channel Lines, Disposal Areas
372		TOESPOIL			
373	RED BUOY	REDBUOY	5201	DNC	Navigation Aides and Annotation
374		BUOYRED			
375	GREEN BUOY	GRNBUIOY	5202	DNC	Navigation Aides and Annotation
376		BOUYGRN			
377	NO WAKE BUOY	NOWAKE	5203	DNC	Navigation Aides and Annotation
378	SWIMMING BUOY	SWIMBUOY	5204	DNC	Navigation Aides and Annotation
379	STUDY GAUGE	STGAUGE	5205	DNC	Navigation Aides and Annotation
380	NAVIGATION LIGHT	NAVLIGHT	5206	DNC	Navigation Aides and Annotation
381	BUOY	BUOY	5207	DNC	Navigation Aides and Annotation
382	DOLPHIN	DOLPHIN	5208	DNC	Navigation Aides and Annotation
383	PILING	PILING	5209	DNC	Navigation Aides and Annotation
384	LEVEE CL	CLLEVEE	5301	Breakline	Levees, Dikes, and Annotation
385		LEVEECL			
386	LEVEE CROWN	LEVEECRN	5302	Breakline	Levees, Dikes, and Annotation
387		CRNLEVEE			
388	LEVEE TOP	LEVEETOP	5303	Breakline	Levees, Dikes, and Annotation
389		TOPLEVEE			
390	LEVEE SLOPE	LEVEESLP	5304	Random	Levees, Dikes, and Annotation
391		SLPLEVEE			
392	LEVEE TOE	TOELEVEE	5305	Breakline	Levees, Dikes, and Annotation
393		LEVEETOE			
394		BOTLEVEE			
395	BERM CROWN	BERMCRWN	5306	Breakline	Levees, Dikes, and Annotation
396		CRWNBERM			
397	BERM TOP	TBERM	5307	Breakline	Levees, Dikes, and Annotation
398		TOPBERM			
399		BERMTOP			
400	BERM SLOPE	BERMSLP	5308	Random	Levees, Dikes, and Annotation
401		SLPBERM			
402	BERM TOE	BBERM	5309	Breakline	Levees, Dikes, and Annotation
403		TOEBERM			
404		BERMTOE			
405	DIKE CROWN	DIKECRWN	5311	Breakline	Levees, Dikes, and Annotation
406	DIKE TOP	DIKETOP	5312	Breakline	Levees, Dikes, and Annotation
407		TOPDIKE			
408	DIKE SLOPE	SLPDIKE	5313	Breakline	Levees, Dikes, and Annotation
409		DIKESLP			
410	DIKE TOE	DIKETOE	5314	Breakline	Levees, Dikes, and Annotation

EM 1110-1-1005
1 Jan 07

411		TOEDIKE			
412	PIPELINE	PIPELINE	5401	DNC	Pipe Lines, Structures, and Bridges
413	O/H PIPE	OHPIPE	5402	DNC	Pipe Lines, Structures, and Bridges
414	PIPELINE SUPPORT	PIPESUPP	5403	DNC	Pipe Lines, Structures, and Bridges
415	ASPHALT REVETMENT EDGE	ASPHREVEDGE	5701	Breakline	Revetments and Annotation
416	ASPHALT REVETMENT	ASPHREV	5702	Breakline	Revetments and Annotation
417	CONCRETE REVETMENT EDGE	CONCREVEDGE	5703	Breakline	Revetments and Annotation
418	CONCRETE REVETMENT	CONCREV	5704	Breakline	Revetments and Annotation
419	CONCRETE MAT REVETMENT EDGE	CONCREVMATE DGE	5705	Breakline	Revetments and Annotation
420	CONCRETE MAT REVETMENT	CONCREVMAT	5706	Breakline	Revetments and Annotation
421	SEE FIELD BOOK NOTE	NOTE	6301	DNC	Unassigned

7-7. Feature and Attribute Libraries for Topographic Field Data

Most data collectors are now designed to hold detailed feature and attribute libraries. Attributes are subsets of a feature, describing standard detail about a common feature. For example, a CONCRETE_PIPE (Feature) may have selectable diameter attributes (24 IN, 36 IN, 48 IN, etc.). An unlimited number of attributes can be set up for a given common feature. The data collector software can be set up to prompt for selected attributes when a given feature (code) is shot. Unprompted attributes can optionally be assessed. Or, uncatalogued attributes can be added for a point. Feature libraries may be created on the data collector or on other PC software and uploaded to the data collector for use during survey operations. The following representative examples are taken from the Trimble Geomatics Office (TGO) Version 1.60, "Feature and Attribute Editor" default library--reference also Trimble Survey Controller Reference Manual (Trimble 2001). The feature and attribute library is created and edited in the TGO software and uploaded to the controller. Feature codes, point styles, line styles, etc. can be saved directly to a Trimble Survey Controller type data collector or to a generic ASCII file that could be uploaded to another data collector (e.g., a TDS-HP48GX). Some of the TGO default point styles are shown in Figure 7-2 below.

Point Style Name	Dimension	Color	Point Symbol	Diameter	Symbol Rotation
Box	Paper		Box	0.0394 in	0
Bush	Paper		Bush	0.2362 in	0
Cross	Paper		Cross	0.0787 in	0
Cross Blue	Paper		Cross	0.0787 in	0
Cross circle	Paper		Cross circle	0.0984 in	0
Cross Red	Paper		Cross	0.0787 in	0
Dia Cross	Paper		Dia cross	0.0591 in	0
Dot	Ground		Dot		0
Double circle	Paper		Double circle	0.0984 in	0
Double Triangle	Paper		Double triangle	0.0984 in	0
Elec Post	Paper		Cross circle	0.0787 in	0
Fire hydrant	Paper		Hydrant	0.0787 in	0
Iron grate	Ground		Iron grate	1.6404 sft	0
Lamp post	Paper		Lamp post	0.1969 in	0
Manhole	Paper		Solid double circle	0.0984 in	0
Power pole	Paper		Solid circle	0.0591 in	0
Sign	Paper		Sign	0.1575 in	0
Single circle	Paper		Single circle	0.0787 in	0
Solid box	Paper		Solid box	0.0591 in	0
Solid circle	Paper		Solid circle	0.0787 in	0
Solid double circle	Paper		Solid double circle	0.0984 in	0
SS Manhole	Paper		Solid double circle	0.0984 in	0
SW Manhole	Paper		Solid double circle	0.0984 in	0
Tree 1	Paper		Tree 1	0.2756 in	0
Tree 2	Paper		Tree 2	0.2756 in	0
Triangle	Paper		Triangle	0.1181 in	0
Triangle circle	Paper		Triangle circle	0.0787 in	0
Valve	Paper		Valve	0.1181 in	0

Figure 7-2 Example of Trimble Default Point Styles

Additional features are easily added to the library using a feature/attribute editor, such as that shown in Figure 7-3 below. Attributes can be added to existing or new features using software compatible with the data collector software. For example, the feature TREE in the TGO default library can be modified using the TGO software, and the modifications exported to the data collector, as shown below.

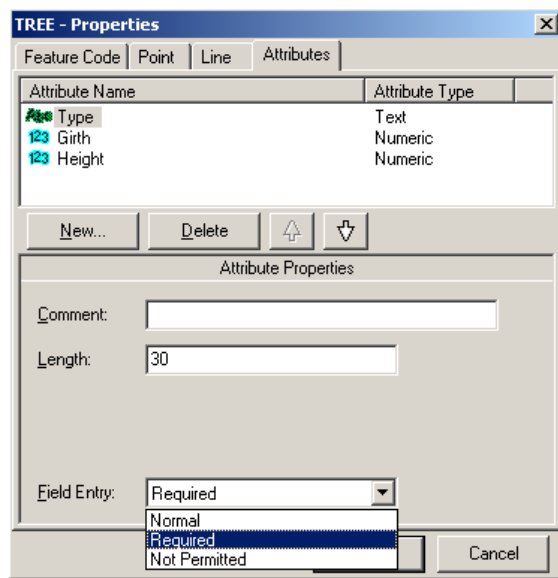

Figure 7-3. Example of Attribute Editor Options (Trimble)

The attributes for the feature TREE can be prompted for field entry, as shown in the pull down window. Numeric entries for GIRTH and HEIGHT can have default entries, minimum and maximum range, and decimal resolution. Any number of additional attributes can be added to this feature using this editor. When attributes are created, they should ideally conform to current USACE directed CADD/GIS standards.

7-8. Control Commands for Connecting Feature Line Strings

Topographic features that have the same feature code may be connected by a line string if that is the nature of the physical object. Examples of connected line strings would be shots taken along a CENTERLINE, BREAKLINE, CURB, EDGE OF SIDEWALK, BUILDING, etc. The individual feature codes input for these continuous objects do not represent the fact that they may be connected by a line string. A “Control Command” in the data collector before and after a string of individual point codes is used to indicate that a series of shots are connected. For example, a command code “CL” may be used to signify a series of shots along a CENTERLINE, with codes such as “CL START” and “CL END” on each end of the string.

a. Adding Control Commands to point codes provides many advantages over single point codes. Real-time field graphical depiction of features, utilities, and facilities is viewable on the controller screen, as opposed to a display of unconnected points. When the control-coded data is exported to a CADD or GIS platform, a significant amount of the mapping editing effort can be eliminated. In effect, adding Control Codes approaches a “field-finish” topographic mapping product, not unlike the “field-finish” drawing that resulted from a plane table survey years ago. Adding detailed Command Codes takes more care and time in the field; however, the advantages of cleaner editing will usually outweigh the lost time involved in the field.

b. Each data collector software vendor has unique Command Code formats. Users should ensure compatibility between the data collector software output and the CADD package that the final drawings will be developed on. Some formats are compatible with only a specific mapping processor. The feature codes tell how to group the points; the command codes tell how to connect the points. For example, TDS

ForeSight software has a *code table* that tells whether linework is required for a group of points and how it is to be plotted: e.g., symbol type, color, size, etc. In the code table you assign each feature code or group of points a specific symbol, a line type, and several other parameters. The code table is a function of the ForeSight program and is discussed in detail in its manual.

7-9. Field Coordinate Geometry Options

Coordinate Geometry (COGO) functions are software routines that perform standard field (and office) survey computations. These COGO routines range from simple ones like inverse computations, to more complex computations such as circular and spiral curve stakeouts or least squares adjustments. Each data collector software package will contain a varying number of these COGO routines. Depending on the type of work an agency performs, only a small number of these COGO features will actually be used in practice.

a. General. COGO (from COordinate GeOmetry) was initially developed by Charles L. Miller of M.I.T. in 1959. Since then, many improvements have been made, but the basic concept and vocabulary have remained the same. COGO is a problem oriented system that enables the user with limited computer experience to solve common surveying problems. The language is based on familiar surveying terminology, such as, Azimuth, Inverse, Bearing, etc. This terminology is used to define the problem and generate a solution. COGO may be used to solve problems such as curve alignments, point offsets, distance, and direction between two points, intersections, etc.

(1) The basis of the system is a series of commands used to manipulate or compute points defined by a point number, x-coordinate, and y-coordinate on a plane surface. These points are stored in what is referred to as the “coordinate table” and may be recalled by their point number in future computations.

(2) The mathematics used for the COGO computations are beyond the scope of this manual. There are many textbooks published that describe the mathematical procedures in detail--see listing at Appendix A-2. The Oregon DOT *Basic Surveying--Theory and Practice* manual (Oregon DOT 2000) is available on the Internet and describes many basic survey computations.

(3) There are many COGO packages on the market today. Several are available for an office PC environment on the Internet free of charge. However, COGO software compatible with a particular total station and data collector should be purchased as a package.

b. Requirements. A few general requirements for a COGO software package are as follows:

- The ability to utilize a combined scale factor in its computations. This will allow the user to calculate the ground distances when staking out a job, or reduce the measured distances to the reference vertical datum, and correct for the scale factor when the survey is to be tied to the SPCS.

- The ability to rotate and scale (transform) the survey points to fit existing control. When the surveyor uses field coordinates to perform the survey job, the survey can be transformed onto the SPCS by defining two points with their SPCS coordinates.

- Compass traverse adjustment is sufficient for the majority of traverses established by the USACE. The ability to perform a least squares adjustment may be advantageous.

- Must have the ability to work in bearings, north azimuth, or south azimuth.

- Allow the export of the coordinate table to an ASCII file.
- Allow the import of points from an ASCII, *.SHP, *.DGN, *.DFX, etc. file.

7-10. General COGO Computation Routines

Each COGO software package on the market has a variety of computational routines. Figure 7-4 illustrates a screen display from a TDS COGO software package used on field data collectors. Most software packages have fairly common COGO functions that are grouped into the categories listed below.

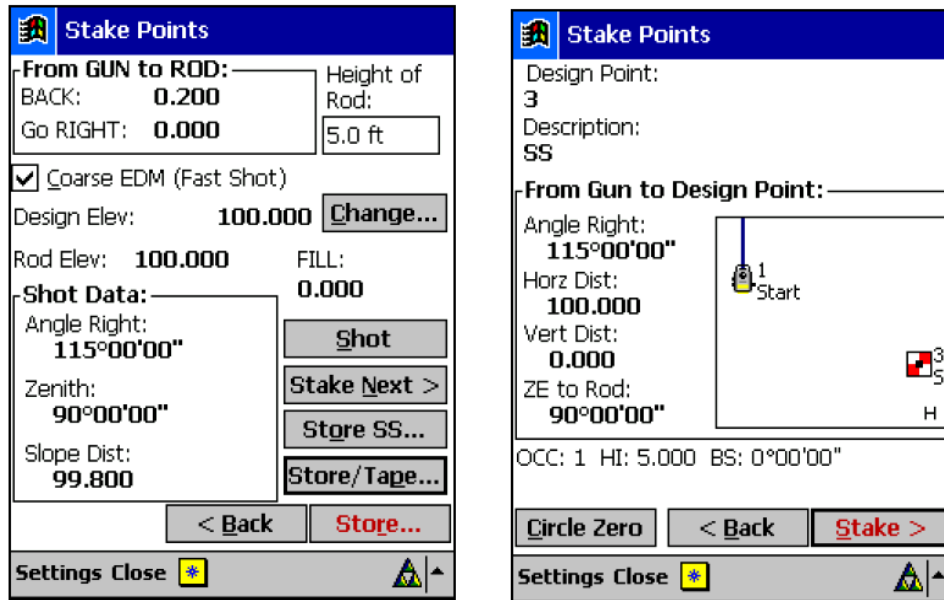

Figure 7-4. COGO screen displays for staking out a remote point (TDS COGO for Pocket PC)

Forward Computation Commands used to calculate the coordinates for a point, given the coordinates of a known point and the distance and direction to the unknown point.

- (1) LOCATE/AZIMUTH: Computes a point given an azimuth and distance from a known point.
- (2) LOCATE/BEARING: Computes a point given a bearing and distance from a known point.
- (3) LOCATE/ANGLE: Computes a point given a backsight point, angle, and distance.
- (4) LOCATE/LINE: Computes a POT (point on tangent) given tangent end points and a distance.
- (5) LOCATE/DEFLECTION: Computes a point given a backsight, deflection angle, and a distance.

Inverse Computation Commands used to compute the distance and direction between two known points. Both the ground and grid distances should be given as output.

- (1) INVERSE/AZIMUTH: Computes the distance and azimuth between two known points.
- (2) INVERSE/BEARING: Computes the distance and bearing between two known points.
- (3) TANGENT/OFFSET: Computes the distance offline and the distance down line given a known point and the ends of a known tangent.

Intersection Commands used to calculate the coordinates of an unoccupied point as the intersection of two vectors of defined direction and/or distance from two known points. Included would also be the various stakeout options--to given templates, slopes, offset alignments, etc.

- (1) LINE/LINE INT: Computes the coordinates of the point of intersection of two lines whose end points are known.
- (2) RANGE/RANGE INT: Computes the coordinates of the intersection of two arcs with known radii and centers. Two answers are possible, so the user must define the desired intersection.
- (3) RANGE/AZIMUTH INT: Computes the coordinates of the intersection of a defined vector and an arc. Two answers are possible, so the user must define the desired intersection.
- (4) AZIMUTH/AZIMUTH INT: Computes the coordinates of the intersection of vectors with known direction.
- (5) FORESECTION: This is an Azimuth/Azimuth intersection, measured by turning angles from two known points.

Curve Commands allow the user to define curve parameters to use defined alignment in computations. Usually circular, transition, and vertical curves are included.

- (1) ALIGNMENT: Given measured curve parameters, computes components of a curve such as:
 - Arc length
 - Long chord
 - Radius
 - Degree of curve
 - Tangent length
 - Center point coordinates
 - External distance
 - Mid ordinate
 - Central angle
 - Vertical curves
- (2) STATION/OFFSET: Computes the coordinates of an unknown point, given a station and offset along the curve. The reverse function is also available to compute the station and offset of a known point relative to the curve alignment.

Traverse Adjustments. Traditional adjustments of traverses using either Compass Rule or Least Squares methods.

Leveling Routines. Input and adjust single-wire, three-wire, digital, or precise leveling.

Resection Computations. Two and Three-Point resection computations used for locating a total station relative to fixed points on a project.

Astronomic Computations. Sun shots or Polaris azimuth observation reductions.

Area Computation Commands which calculate the area of polygons and curve segments. The COGO package should calculate the area based on ground distances, not the reduced distances.

Volume Computations used for cut/fill or measurement and payment. Most COGO software uses Average End Area volume formulas. More sophisticated software will be able to perform surface-to-surface volume computations based on a generated DTM or TIN from observed topographic shots.

Coordinate Transformation Commands used to rotate, translate, scale, and best fit (warp) between coordinate systems, using either 3- or 7-point transformation routines.

Graphical Display of COGO Functions. Provide a graphical screen display of COGO calculations, such as stakeout, curves, etc.

The following paragraphs contain representative examples of some of the more commonly used COGO routines used in the field. The algorithms used in these COGO routines can be found in any of the surveying texts listed at Appendix A-2. These examples are taken from TDS HP-48GX software or the Trimble TSC software--COGO routines are all basically the same, regardless of the software vendor (e.g., 3-point resection algorithms are identical in output).

7-11. Total Station Resection Computations

Generally, total stations are set up over known control points and oriented in azimuth to another fixed point. Often the total station must be set up at a remote point in order to observe areas not visible from the established control points. This typically occurs on property surveys where multiple corners have been recovered but cannot be physically occupied with the instrument. In such a case, the instrument is set up at an unmarked point that can see two or more of the property corners plus affords good visibility to the survey area.

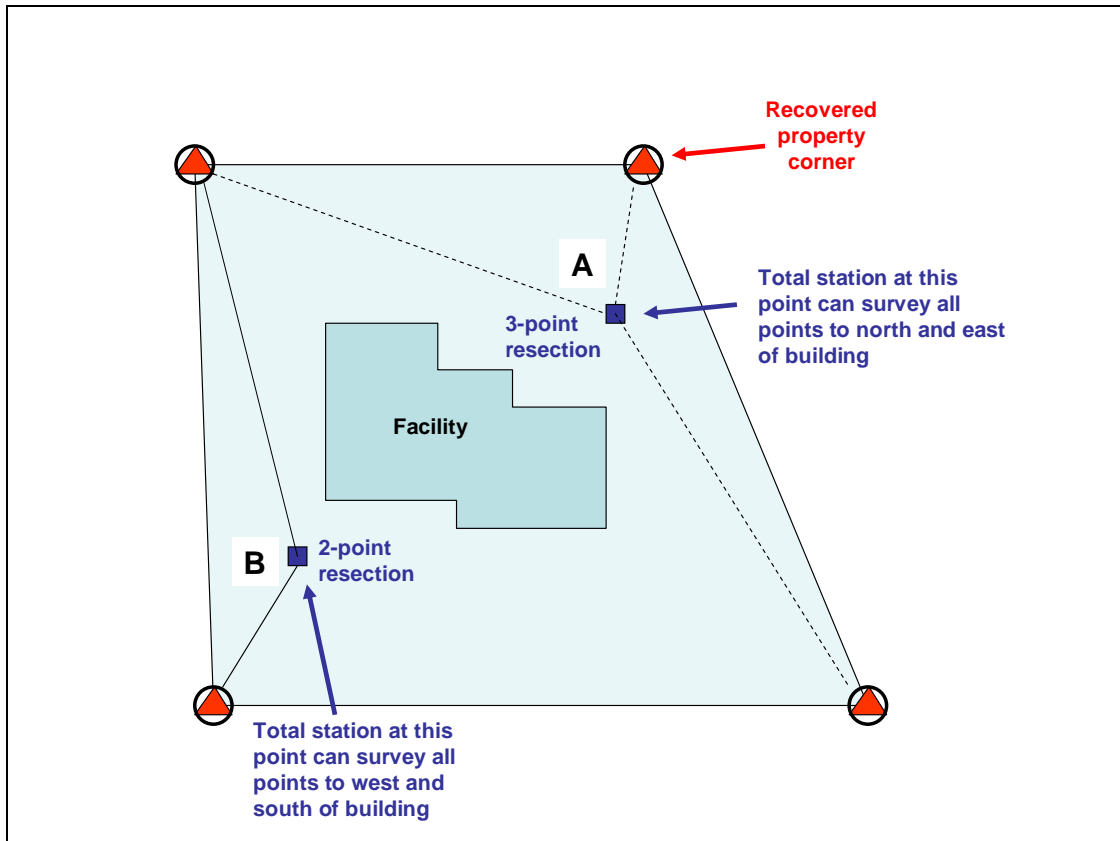



Figure 7-5. Two- and Three-point total station resections

As illustrated in Figure 7-5 above, the total station is set at points A and B in order to delineate facilities, utilities, and topography on this site. From these two points, the entire project site (including the building exterior walls) can be viewed. To position the instrument relative to the recovered property corners, either two- or three-point resections can be performed, as shown at points B and A respectively. The rodman places the prism pole at each corner and shots are taken and saved in the data collector. In practice, only a two-point resection would be performed at both points A and B since the total station can measure distances to both points and the angle between them; providing a redundant solution of the instrument's position. (Three-point resections require only observing of the two angles--three directions--between the three points for a solution--a practice once performed with traditional transits or theodolites). Some COGO software will perform a least-squares adjustment of the resected position when redundant observations are obtained--i.e., both directions and distances on a two-point resection or three directions plus one or more distances on a three-point resection. Likewise, an adjustment would be performed if four or more points were used in a resection. Options for 2D and 3D resection adjustments are available on commercial COGO packages.

The following Figure 7-6 is taken from Tripod Data System fieldwork software (TDS 1999). It illustrates a two-point resection on a HP 48 type data collector, which is similar to more current CE-based data collectors. In this example, the total station is set at point "50," and is backsighted on point "6" (assumed azimuth of 000 deg). A two-point resection is made between point "6" and point "1," as shown in the first table. The two field steps are shown on the following HP 48 menu screen displays. After the direction and distance to the second point is observed, pressing "SOLVE" on the HP 48 will initiate the resection computation. The solved X-Y-Z coordinates of the unknown point "50" will be displayed along with a comparison of the precision of the observation based on the redundancy in the solution.

Back Sight	Occu- pied Point	Fore- Sight	Height of Instru. [HI]	Height of Rod [HR]	Horizontal Angle (circular) [HA]	Zenith Angle [ZA]	Slope Dist. [SD]
[BS]	[OC]	[FS]					
6	50	6	5.42	6.0	0.0000	88.1347	162.19
6	50	1	5.42	6.0	74.1810	91.0713	498.91

This data is entered in the Two-Point Resection screen.

Path: Press the direct access key  [RESCT2] or [L]. As with all direct access keys, it can also be accessed from the Main Menu, then [M] CO-GO menu, then [L] Resect (2P).

Step 1: Enter the data for this example as shown in the screen below:

```

Resection from 2 Pts
Option: >Direct only
First pt: 6
HI:5.420   HR:6.000
Circular:  0.0000
Zenith ang: 88.1347
Slope dist: 162.190

```

<= Direct & Rev /
Direct only

SOLVE

EXIT

Step 2: Press [SOLVE] and the TDS-48 will go on to the second point. The next screen will appear. Fill it out as shown below:

```

Resection 2nd Pt
second pt: 1
           HR:6.000
store pt:  50
Circular : 74.1810
Zenith ang: 91.0713
Slope dist: 498.910

```

SOLVE

EXIT

Figure 7-6. Screen displays from a HP 48 Two-Point Resection (Tripod Data Systems)

7-12. Line-Line Intersection Computations

Often the center of a rectangular object cannot be sighted but the corners can be cut in from one of more set ups. An example might be a steel tower structure where all four legs can be sighted from a single total station setup point--see Figure 7-7. The legs are shot with a prism at the base or at a constant elevation using a reflectorless total station. Given the coordinates of the four corners, the center of the object can be calculated. Most COGO routines can do this automatically and store the final coordinates of the object's center.



Figure 7-7. Steel tower structures requiring line-line intersections to compute center coordinates based on coordinates observed on each tower leg

Following is an excerpt from a TDS *.rw5 file showing multiple observations to four points. Initially the ground elevation of the approximate center of the tower is shot "FP3"--yielding a relative elevation of 101.18 ft as solved in the *.txt file from the data collector. Next, the four legs of a tower ("TL") are shot at a constant point about 60 ft above the ground--points FP5 thru FP8. The position of the center (Point 9 --"CTR TWR GROUND") is computed from the inverted intersection between the pairs of legs (shown as points 5 through 8 in the solved *.txt coordinate file). The ground elevation (101.18 ft) is manually input into the data collector to override the computed elevation at the elevated point on the tower that was actually shot.

```
SS,OP1,FP3,AR149.19000,ZE90.09150,SD86.790,--GROUND

SS,OP1,FP6,AR157.26250,ZE55.57200,SD97.338,--TL
SS,OP1,FP5,AR148.12250,ZE61.10000,SD113.340,--TL
SS,OP1,FP7,AR167.37450,ZE60.52150,SD112.328,--TL
SS,OP1,FP8,AR158.09550,ZE64.15150,SD126.306,--TL

SP,PN9,N 4909.8793,E 5036.6561,EL100.1800,--CTR TWR GROUND
```

TDS solved *.txt file output:

3,	4925.3608054400,	5044.2881496600,	100.1864730500,	GROUND
5,	4915.6088197900,	5052.3105890000,	160.0797345600,	TL
6,	4925.5170666700,	5030.9428381600,	159.9132991600,	TL
7,	4904.1569677500,	5021.0213152200,	160.0990367500,	TL
8,	4894.3940359500,	5042.3136274700,	160.2847694200,	TL
9,	4909.8792864900,	5036.6560961400,	100.1800000000,	CTR TWR GROUND

Chapter 8 Total Station Topographic Survey Procedures

8-1. Purpose

This chapter provides general guidance on the use of total stations on topographic surveys. This chapter includes information on reflectorless/robotic systems and prism-only systems. Use and operation of internal and external data collectors with a total station are covered. Additional examples of total station applications on Corps military and civil projects are provided in appendices to this manual.



**Figure 8-1. Wild TC-1010 Total Station with TDS-HP48GX Data Collector
1998 Levee Survey at Bayou Segnette (New Orleans District)**

8-2. Total Stations

Total stations combine electronic theodolites and EDM into a single unit. They digitally observe and record horizontal directions, vertical directions, and slope distances. These digital data observations can be adjusted and transformed to local X-Y-Z coordinates using an internal or external microprocessor. Various atmospheric corrections, grid and geodetic corrections, and elevation factors can also be input and applied. The total station may internally perform and save the observations or (more commonly) these data may be downloaded to an external data collector. With the addition of a data collector, the total station interfaces directly with onboard microprocessors, external PCs, and software. Electronic theodolites operate in a manner similar to optical theodolites. Angles can be electronically encoded to one arc-second with a precision down to 0.5 arc-second. Digital readouts eliminate the uncertainty associated with reading and interpolating scale and micrometer data. The electronic angle-measurement system minimizes some of the horizontal and vertical angle errors that normally occur in conventional theodolites. Angular measurements are based on the reading of an integrated signal over the surface of an

electronic encoder that produces a mean angular value and completely eliminates the inaccuracies from eccentricity and circle graduation. These instruments also are equipped with a dual-axis compensator, which automatically corrects both horizontal and vertical angles for any deviation in the plumb line.



Figure 8-2. Leica TCR-705 Reflectorless Total Station (Geodetic Services, Inc.)



Figure 8-3. Trimble TSC and HP48 Data Collectors

a. The development of the total station has made it possible to accurately gather enormous amounts of survey measurements quickly. In the last 20 years, total stations and data collectors have become common field equipment, and have largely replaced the traditional survey methods that utilized transits, theodolites, and alidades. Digital theodolites and EDM instruments were perfected during the 1970s. In the early 1980's the surveying instrument manufacturers introduced what has become the total station, redefining the term by creating an entirely electronic instrument that combined the heretofore separate digital theodolites and EDM devices. Directly storing direction and distance observations to a microprocessor helped eliminate many of the reading errors that can occur with an optical theodolite or traditional EDM where observations are hand recorded. Along with the advent of the electronic theodolite came the electronic data collector, thus minimizing both the reading errors and the writing errors. Modern total stations can measure a distance to an accuracy of better than 5 millimeters plus 1 part per million, with some variation depending on the type of reflecting surface or prism used. Electronic angles can be resolved to about one-half arc second, although models used for construction may have a resolution of only 30 seconds. In most land surveying situations, the normal crew size can be reduced to two persons when equipped with a standard total station, and one person when using robotic total stations.

b. Traditionally, surveying has used analog methods of recording data. Digital data collection methods using electronic total stations are far more efficient. Total stations have dramatically increased the amount of topographic data that can be collected during a day and are well suited for topographic surveys in urban landscapes and busy construction sites. Modern total stations are also programmed for construction stakeout and highway centerline surveys. When proper procedures are performed, total stations have made trigonometric leveling nearly as accurate as many of the differential level techniques in areas possessing large relief landforms. Total station instruments and associated data collectors can quickly transfer 3D coordinates and are capable of storing unique mapping feature codes and other parameters which in the past could only be recorded on paper media such as field books.

8-3. Total Station Features and Operation

There are less than a dozen manufacturers of total stations that commonly market in the US. Each manufacturer may have varied models, with optional features that can be tailored to local operating conditions, such as accuracy requirements, project size (EDM distances), and available crew size. Selection of a particular model, along with the associated data collector and CADD software, requires some research. A good place to start would be viewing periodic surveys by trade publications (see POB 2004a and POB 2004b in the references at Appendix A). Discussions with users at other Districts, local survey suppliers, and AE survey contractors are also recommended. Exhibitor demonstrations at state survey society meetings is another good place to observe and test new equipment. In some cases, vendors will offer to come to the district and demonstrate their equipment in your local working environment

a. General operation. Total station surveys are performed similarly to transit-stadia or plane-table-alidade surveys. Total stations are set up over control points similarly to traditional transits, theodolites, or EDM. Most employ a three-screw, forced-centering Wild-type tribrach mount to fasten and align the total station with the tripod. Heavy wooden or fiberglass tripods are best for supporting total stations. Leveling over a point is performed no differently than traditional instrument methods. The tribrach is roughly centered over the point first using the standard tripod leg adjustment technique. The total station is then mounted in the three-pin tribrach and internally leveled using either level vials or electronic dual-axis methods, depending on the type of instrument. Either optical or laser plummets are used for final centering over a point. Some total stations provide out of level warnings to the operator. All plummets, optical or digital, should periodically be checked, adjusted, and calibrated. A conventional plumb bob provides such a check if used in ideal conditions.

b. Prism poles. A variety of target poles are used for the remote rod to which topographic observations are made. Both adjustable and fixed height poles are common--see Figure 8-4 below. Extendable rods (to 20 feet and higher) may be used--especially on beach profiling surveys and in canopy areas. For most applications, a retro-reflector prism is attached to the top of the prism pole such that there is no eccentric offset correction required. If not, then the retro-reflector offset correction must be determined and applied to observed distances. Use of a fixed height pole helps minimize HR blunders. A shoe for the pole point may be needed in soft ground. A standard rod level is used to plumb the prism pole over a point. Many poles have built-in rod levels to facilitate plumbing the prism.



Figure 8-4. Prism pole (Portland District)

c. EDM range and accuracy. Ranges with standard prisms and reflectorless models vary widely between manufacturers. Both infrared and laser EDMs are used. Distance resolution is either pulsed (low accuracy) or phase comparison (typical ± 2 to ± 5 mm accuracy). One and three array prism ranges can vary from one mile to over 5 miles. Ranges of reflectorless total stations are specified relative to 90% and 18% Kodak grey cards, and can vary from 300 ft to over 3,000 ft. Reflectorless accuracies are not as good as prism accuracies given the variability of the reflecting terrain, and may therefore may not be suitable for more accurate surveys such as FEMA first floor elevation certificates. At the outer range limits, bicycle reflector tape or a prism rod with a retroreflector may be needed. Refer to POB 2004a for details on reported range and accuracy specifications by individual manufacturers.

d. Instrument controls. Focus and plate control tangent and locking screws vary widely between total station brands. A 30X optical zoom is common on most total stations. These controls should be operated in accordance with the manufacturer's instructions.

e. Cost. Total station costs obviously will vary with the accuracy and added features. A simple digital theodolite (no data collection) will cost less than \$1,500. A basic total station survey package (including tripod and prism pole) will cost about \$7,500 and reflectorless or robotic units can cost upwards of \$20,000. A data collector and software must be purchased separately--a \$1,500 to \$4,000 additional cost. A field laptop computer will run \$2,000 to \$3,000. Miscellaneous survey equipment can easily exceed another \$3,000--e.g., extra tripods, total station batteries, 25-ft telescoping rod, additional prisms, magnetic locater, etc.

f. Angular accuracy. Angle standard errors range from $\pm 1''$ to $\pm 5''$ based on a Direct and Reverse set. Less accurate models are available for construction layout application--e.g., 1-minute instruments. See POB 2004a for additional specifications on collimation corrections, orientation options, and plate vial bubble sensitivities for various units. Refer to any of the texts listed in Appendix A-2 for detailed descriptions of theodolite and total station alignment and calibration requirements.

g. Data collectors. (see Chapter 6).

h. Other features. Other factors to be considered in the selection of a particular total station include: robotic search controls, measurement time, integrated laser scanners, integrated GPS, internal digital camera, internal data storage capacity, internal COGO and stakeout capabilities, compatibility with existing data collector (if not purchased with the total station), weight (including batteries and battery life), ease of operation, and training needs.



Figure 8-5. TOPCON GPT-8200 Series Reflecterless-Robotic Total Station can make reflectorless measurements out to 4,000 ft and prism measurements to 23,000 ft

8-4. Reflectorless and Robotic Total Stations

Reflectorless and robotic total stations have an unlimited number of applications. They allow one-man survey crew operation. Reflectorless total stations can position objects that cannot be positioned with a

reflector prism, such as towers, tanks, roof eaves, overhead cables or power lines, overhead pipes, stockpiles, traffic areas, and potentially hazardous areas (unexploded ordinance). Robotic total stations have the advantage of one-man crew operation. In addition, they allow the instrument to be left unattended at secure sites. The instrumentman then records data at the rod/prism point, where a particular feature can be better identified. Typical units are shown in Figure 8-5 (above) and Figure 8-6 (below).



Figure 8-6. Trimble 5600 DR Reflectorless-Robotic Total Station with ACU Survey Controller

The data collector shown in the above figure is a Trimble ACU Survey Controller, which contains a color graphical display and uses a Windows CE operating system. This data collector can be used with the total station as shown, with a RTK topographic system, or as a robotic rover.

8-5. Field Equipment Inventory and Maintenance

Modern electronic survey equipment requires surveyors to be maintenance conscious of their equipment. Special concerns include power sources and whether or not the instruments and accessories are accurately adjusted and in good repair. When setting up a crew to work with a total station and data collector, it is helpful to supply the party chief with a checklist to help the crew maintain its assigned equipment and handle the collected data upon returning to the office. It is also important that each crew be supplied with all necessary equipment and supplies. These should be stored in an organized and easily accessible manner.

a. Typical equipment inventory for a two-man crew. Listed below is equipment list that would support a two-person crew, consisting of a party chief/rodperson and a notekeeper/instrument person. This should be a sufficient equipment inventory to meet the general needs of boundary, layout, and topographic surveys. It is assumed that this crew has a regular complement of supplies such as hammers, shovels, cutting tools, ribbon, stakes, lath, and safety equipment.

- Total station
- Data collector
- Batteries for 14 hours of continuous operation plus backup supply
- 3 tripods
- 2 tribrachs
- 2 target carriers

- 1 fixed height range pole and 1 adjustable pole
- 2 target holders
- 2 reflectors
- 2 two-way radios

b. Additional equipment. With this basic equipment inventory, a two-person field crew will be able to handle most survey tasks that are routinely encountered in day-to-day operations. An additional tripod, range pole, carrier, tribrach, and reflector would give the crew even greater flexibility, and allow them to handle many projects more efficiently. It is also helpful for the field crew to have a convenient place to store their assigned equipment. Crews should be equipped with briefcase-sized cases that will hold tribrachs, reflectors with holders, carriers, and target plates. A hard camera case or pistol case works well for this purpose. With all the components stored in one place, it makes inventory of the equipment easy and reduces the chance of equipment being left at the job site. This also allows for proper equipment maintenance.

c. Equipment maintenance. The following checklist will aid each crew in properly maintaining and keeping inventory of their assigned equipment. At the end of each workday the party chief should check that the following duties have been performed:

- Clean all reflectors and holders. A cotton swab dipped in alcohol should be used on the glass surfaces. A crew member can do this during the trip back to the office.
- Clean tribrachs. They should be dusted daily.
- Remove dust from all instruments. A soft paintbrush or a shaving brush works well. If an instrument has been exposed to moisture, thoroughly dry it and store in an open case.
- Download the data collector to the computer.
- Backup all files generated from the download and check the integrity of the backup files before erasing the field data from the data collector.
- Clean batteries and connect to charger. Some batteries require a 14- to 20-hour charge, so one set of batteries may have to be charged while a second set is in operation.

d. Battery maintenance. One of the biggest problems faced by the users of total stations with data collectors is maintaining an adequate power supply. Most total stations have small, removable, rechargeable Ni-Cad or gel-cell batteries. There are several factors that should be considered when assessing power needs:

(1) Type of survey. A topographic survey usually entails much more data collection in a day than a boundary survey. Determine the number of measurements that you would normally make in a day and consult the manufacturer's specifications to determine the number of shots you can expect from a fully charged new battery. In general, some 4 to 8 hours of continuous use is available, based on one EDM measurement every 30 seconds (POB 2004a). Larger batteries are available to extend observation time.

(2) Age of batteries. Keep in mind that batteries will degrade over a period of time. This means that a new battery, with sufficient power for 500 measurements when new, may only be capable of 300 measurements after a year of use. With an inverter, extra backup batteries can be charged in the survey vehicle.

(3) Time needed to charge batteries. Total station batteries take 3 to 5 hours to fully charge. Multiple battery chargers should be obtained in order to keep a sufficient supply of batteries on hand each morning.

(4) In addition to the proper assessment of power need, a record of the history and current status of the power supply should be readily available. When batteries begin to get weak there is generally a rapid deterioration in their performance. To monitor the performance of a particular battery record the serial number in a battery log book. If problems arise with a particular unit, check the log to see when the battery was purchased or when it was last recelled. Next try discharging and recharging the battery. If performance is still not up to speed, have it checked to determine the weak cell and replace it. If the battery was not new or was recelled in the last year, recell the entire unit. When one cell goes the next one is usually only a charge or two from failure. The cost of having a battery recelled is minimal when considering the cost of lost work time due to power failure.

(5) Also record the date the battery was charged on the shipping label that is attached to the battery box. When the battery is fully used simply cross out the date, thus eliminating the confusion of not knowing which battery needs to be charged. Monitor the shelf time of the battery, and if it exceeds 10 days, recharge it. This keeps the power supply at peak performance. Always consult the operator's manual for recharge specifications.

e. Backup power. It is always a good idea to have backup power available for that last 15 minutes of work. Most manufacturers can provide cabling for backup to an automobile battery. Some can even supply a quick charge system that plugs into the cigarette lighter. Power pointers are:

- Assess power needs for the particular job
- Assess power usage of the equipment
- Monitor performance of each battery
- Monitor battery age, usage, and recell information
- Have one day's worth of backup power readily available

8-6. Total Station Job Planning

An often-asked question when using a total station with a data collector is "How do I plan a project?" To answer this question, first examine the productivity standards expected of field crews.

a. Most crews will make and record hundreds of observations per day. This includes any notes that must be put into the system to define what was measured. When creating productivity standards keep in mind that a learning curve is involved. Usually it takes a crew some four to five projects to become familiar with the equipment and the coding system to start reaching the potential productivity of the system.

b. A two-person crew is most efficient when the nominal spacing of the measurements is less than 50 feet. When working within this distance the average rod person can acquire the next target during the time it takes the instrument operator to complete the measurement and input the codes to the data collector. The instrument operator usually spends 20 seconds (\pm) sighting a target, recording a measurement, and another 5-10 (or more) seconds coding the measurement.

c. When the general spacing of the data exceeds 50 feet, having a second rod person will significantly increase productivity. A second rod person allows the crew to have a target available for measurement while the first rod person is moving. If the distance of the move is 50 feet or greater, the instrument will be idle with only one rod person.

d. When dealing with strip topographic situations, it may be necessary to acquire data every 3 feet along the length of the job. In urban areas the data may seem to be denser, but the rights-of-way are

generally wider. Some feel that one measurement for every 3 feet of linear topography works very well for estimating purposes. Using this estimate, an average field crew can make and record between 350-500 measurements or 1,000-1,500 feet of strip topography per day. A two-person crew equipped with recording total station and data collector can pick up 1,250 feet a day. Depending on the office/field reduction software being used, these data can produce both the planimetric and contour maps as well as transfer the data to an engineering design package with very little additional manipulation.

8-7. Total Station Error Sources

All theodolites measure angles with some degree of imperfection. These imperfections result from the fact that no mechanical device can be manufactured with zero error. In the past very specific measuring techniques were taught and employed by surveyors to compensate for minor mechanical imperfections in theodolites. With the advent of electronic theodolites, the mechanical errors still exist but are related to in a different way. One must now do more than memorize techniques that compensate for errors. One must clearly understand the concepts behind the techniques and the adjustments for errors that electronic theodolites now make. The following paragraphs provide the major sources of error when using a theodolite and also the particular method employed to compensate for that error.

a. Circle eccentricity. Circle eccentricity exists when the theoretical center of the mechanical axis of the theodolite does not coincide exactly with the center of the measuring circle. The amount of error corresponds to the degree of eccentricity and the part of the circle being read. When represented graphically circle eccentricity appears as a sine wave. Circle eccentricity in the horizontal circle can always be compensated for by measuring in both faces (opposite sides of the circle) and using the mean as a result. Vertical circle eccentricity cannot be compensated for in this manner since the circle moves with the telescope. More sophisticated techniques are required.

(1) Some theodolites are individually tested to determine the sine curve for the circle error in that particular instrument. Then a correction factor is stored in ROM that adds or subtracts from each angle reading so that a corrected measurement is displayed.

(2) Other instruments employ an angle-measuring system consisting of rotating glass circles that make a complete revolution for every angle measurement. These are scanned by fixed and moving light sensors. The glass circles are divided into equally spaced intervals which are diametrically scanned by the sensors. The amount of time it takes to input a reading into the processor is equal to one interval, thus only every alternate graduation is scanned. As a result, measurements are made and averaged for each circle measurement. This eliminates scale graduation and circle eccentricity error.

b. Horizontal collimation error. Horizontal collimation error exists when the optical axis of the theodolite is not exactly perpendicular to the telescope axis. To test for horizontal collimation error, point to a target in face one then point back to the same target in face two; the difference in horizontal circle readings should be 180 degrees. Horizontal collimation error can always be corrected for by meaning the face one and face two pointings of the instrument.

(1) Most electronic theodolites have a method to provide a field adjustment for horizontal collimation error. Again, the manual for each instrument provides detailed instruction on the use of this correction.

(2) In some instruments, the correction stored for horizontal collimation error can affect only measurements on one side of the circle at a time. Therefore when the telescope is passed through zenith (the other side of the circle is being read), the horizontal circle reading will change by twice the collimation error. These instruments are functioning exactly as designed when this happens.

(3) When prolonging a line with an electronic theodolite, the instrument operator should either turn a 180-degree angle or plunge the telescope and turn the horizontal tangent so that the horizontal circle reading is the same as it was before plunging the telescope.

c. Height of standards error. In order for the telescope to plunge through a truly vertical plane the telescope axis must be perpendicular to the standing axis. As stated before there is no such thing as perfection in the physical world. All theodolites have a certain degree of error caused by imperfect positioning of the telescope axis. Generally, determination of this error should be accomplished by a qualified technician because horizontal collimation and height of standards errors interrelate and can magnify or offset one another. Horizontal collimation error is usually eliminated before checking for height of standards. Height of standards error is checked by pointing to a scale the same zenith angle above a 90-degree zenith in "face-one" and "face-two." The scales should read the same in face one as in face two.

d. Circle graduation error. In the past, circle graduation error was considered a major problem. For precise measurements surveyors advanced their circle on each successive set of angles so that circle graduation errors were "meaned out." Current technology eliminates the problem of graduation errors. This is accomplished by photo-etching the graduations onto the glass circles and making a precise master circle and photographing it. An emulsion is then applied to the circle and a photo-reduced image of the master is projected onto the circle. The emulsion is removed and the glass circle has been etched with very precise graduations.

e. Vertical circle error. It is important to check the vertical circle indexing adjustment on surveying instruments on a routine basis. When direct and indirect zenith angles are measured to the same point, the sum of the two angles should equal 360° . Over time, the sum of these two angles may diverge from 360° and consequently cause errors in vertical angle measurements. While averaging the direct and indirect zenith angles easily eliminates this error, on many jobs it may not be cost effective to make two readings. Acceptable accuracy may still be maintained for many applications with only a direct reading; however, as long as the index error is kept to a minimum by periodically performing a vertical adjustment, such as TOPCON's "Vertical Angle 0 Datum Adjustment." Most total stations are provided with some type of electronic adjustment to correct the vertical circle indexing error. This adjustment takes just a few seconds and will insure that you get good vertical angle readings with just one measurement. Consult the manufacturer's manual for instructions on making this adjustment.

f. Pointing errors. Pointing errors are due to both human ability to point the instrument and environmental conditions limiting clear vision of the observed target. The best way to minimize pointing errors is to repeat the observation several times and use the average as the result.

g. Uneven heating of the instrument. Direct sunlight can heat one side of the instrument enough to cause small errors. For the highest accuracy, utilize an umbrella or pick a shaded spot for the instrument.

h. Vibrations. Avoid instrument locations that vibrate. Vibrations can cause the compensator to be unstable.

i. Collimation errors. When sighting points a single time (e.g., direct position only) for elevations, check the instrument regularly for collimation errors.

j. Vertical angles and elevations. When using total stations to measure precise elevations, the adjustment of the electronic tilt sensor and the reticule of the telescope becomes very important. An easy way to check the adjustment of these components is to set a baseline. A line close to the office with a

large difference in elevation will provide the best results. The baseline should be as long as the longest distance that will be measured to determine elevations with intermediate points at 100- to 200-ft intervals. Precise elevations of the points along the baseline should be measured by differential leveling. Set up the total station at one end of the baseline and measure the elevation of each point. Comparing the two sets of elevations provides a check on the accuracy and adjustment of the instrument. Accuracy requirements may dictate that more than one set of angles and distances is measured to each point. Some examples are distances over 600 feet, adverse weather conditions, and steep observations.

k. Atmospheric corrections. Meteorological data corrections to observed EDM slope distances may be significant over longer distances. Usually for most topographic surveying over short distances, nominal (estimated) temperature and pressure data is acceptable for input into the data collector. Instruments used to measure atmospheric temperature and pressure must be periodically calibrated. This would include psychrometers and barometers.

l. Optical plummet errors. The optical plummet or tribrachs must be periodically checked for misalignment. This would include total stations with laser plummets.

m. Adjustment of prism poles. When using prism poles, precautions should be taken to ensure accurate measurements. A common problem encountered when using prism poles is the adjustment of the leveling bubble. Bubbles can be examined by establishing a check station under a doorway in the office. First, mark a point on the top of the doorway. Using a plumb bob, establish a point under the point on the doorway. If possible, use a center punch to make a dent or hole in both the upper and lower marks. The prism pole can now be placed into the check station and easily adjusted.

n. Recording errors. The two most common errors are reading an angle incorrectly and/or entering incorrect information into the field book. Another common (and potentially disastrous) error is an incorrect instrument or rod height. Although electronic data collection has all but eliminated these errors, it is still possible for the surveyor to identify an object incorrectly, make a shot to the wrong spot, or input a bad target height (HR) or HI. For example, if the surveyor normally shoots a fire hydrant at the ground level, but for some reason shoots it on top of the operating nut, erroneous contours would result if the program recognized the fire hydrant as a ground shot and was not notified of this change in field procedure.

o. Angles. As a rule, a surveyor will turn a doubled angle for move-ahead, traverse points, property corners, or other objects that require greater accuracy. On the other hand, single angles are all that are required for topographic shots. Refer to the total station operating instructions for repeating angle methods where required.

p. Slope to grid and sea level EDM corrections. Slope distances will be reduced to horizontal distances in the data collector, and then reduced to a grid distance if a grid scale factor (or combined scale sea level factor) is input into the data collector. For most topographic survey applications involving short side shots, the grid scale factor is ignored (e.g., 1.000 is used). This would not be correct for control traverses covering larger distances. Scale factors can be obtained directly in CORPSCON.

q. EDM calibration. All EDM instruments should be periodically (at least annually) checked over a NGS Calibration Baseline or a baseline established by local state surveying societies.

8-8. General Total Station Operating Procedures

A set routine should be established for a survey crew to follow. Standard operating procedures should require that control points be measured and noted immediately on the data collector and/or in the field book after the instrument has been set up and leveled. This ensures that the observations to controlling points are established before any outside influences have had an opportunity to degrade the setup. In making observations for an extended period of time at a particular instrument location, reobserve the control points from time to time. This ensures that any data observed between the control shots are good, or that a problem has developed and appropriate action can be taken to remedy the situation. As a minimum, require survey crews to observe both vertical and horizontal control points at the beginning of each instrument setup and again before the instrument is picked up. One of the major advantages of using a total station equipped with data collection is that some errors previously attributed to blunders (e.g., transposition errors) can be minimized or eliminated. Even if the wrong reading is set on the horizontal circle in the field or the wrong elevation is used for the bench, the data itself may be precise. To make the data accurate, many software packages will allow the data to be rotated and/or adjusted as it is processed. The only way to assure that these corrections and/or observations have been accurately processed is to compare the data to control points. Without these observations in the recorded data, the orientation of that data will always be in question. The use of a total station with a data collector can be looked upon as two separate and distinct operations. The following procedure is typical of most total stations and data collectors:

a. Total Station

- If EDM is modular, mount it on instrument.
- Connect data collector.
- Set up and level instrument.
- Turn on total station.
- Set atmospheric correction (ppm). This should be done in the morning and at noon.
- Set horizontal circle.
- Set coordinates.
- Observe backsight (check whether azimuth to backsight is 180 degrees from previous reading).
- Observe backsight benchmark (obtain difference in elevation). This may require factoring in the height of reflector above benchmark.
 - Compute relative instrument height (benchmark elevation +/- difference in height). Note height of rod (HR) and note computations in field book.
 - Input Z (elevation) value in instrument or data collector.
 - Observe backsight benchmark (check elevation).
 - Invert and repeat (check elevation).

b. Data Collector

- Record date and job number.
- Record crew number and instrument serial number.
- Record field book number and page number.
- Record instrument location (coordinates).
- Record backsight azimuth.
- Record standard rod height.
- Record height of instrument.

[Note: All the above information may also be recorded in a field book if necessary]

- Observe and record measurement to backsight benchmark.
- Enter alpha or numeric descriptor of above point into data collector.
- Observe and record measurement backsight benchmark or check benchmark (if setting benchmark, note in field book and repeat with instrument inverted).
 - Enter alpha or numeric descriptor of above point into data collector.
 - Observe and record measurement to backsight.
 - Enter alpha or numeric descriptor of above point into data collector.
 - Invert and repeat the above two steps.
 - Observe and record measurement to foresight.
 - Enter alpha or numeric descriptor of above point into data collector.
 - Invert and repeat the above two steps.
 - Observe and record measurement to side shot.
 - Enter alpha or numeric descriptor of above point into data collector (repeat the above two steps as needed).
- When setup is complete, or at any appropriate time, repeat shots on vertical and horizontal control. Observe the displays and record in data collector.

c. *Precautionary guidance and recommendations on total stations.* The following guidance from the CALTRANS *Surveys Manual* (CALTRANS Surveys Manual 2001-2004) is applicable to total station operation.

- Never point the telescope directly at the sun as the sun's rays may damage the diodes in an electronic distance measuring instrument (EDMI).
 - If possible, shade the instrument from direct sunlight as excess heat may reduce the range of the sender diodes in the EDM.
 - To maintain maximum signal return at longer ranges, shade prisms from direct sunlight.
 - Avoid multiple unrelated prisms in the same field of view; this can cause blunders in distance observations.
 - Do not transmit with a two-way radio near the total station during EDM measurements.
 - Most total stations are equipped to detect and correct various instrumental errors. If such errors exceed program limits, error codes will indicate the error. Consult the operator's manual for exact procedures and error codes.
 - Do not carry tripod-mounted instruments over the shoulder.
 - Whenever possible, select instrument setup locations to minimize the exposure of the instrument operator, other members of the crew, and the instrument to danger. Select stable ground or footing for the tripod feet. Do not set an instrument directly in front of or behind a vehicle or piece of construction equipment that may suddenly move.
 - Don't leave instruments unprotected or unattended.
 - In the event that the instrument or any personnel are required to be in an area subject to traffic, protection procedures must be followed.

8-9. Total Station Angle Measurement and Traverse Techniques

Most total stations provide a variety of methods for observing traverse or sideshot angles (or directions). Generally, three modes are available, depending on the angular accuracy required. The following modes are available on typical data collectors when configured with a total station.

- Single - a single horizontal angle shot will be taken.
- Directional - the sequence of shots to determine the horizontal angle for each point is as follows: direct to the backsight; direct to the foresight; reverse (invert) the scope; reverse to the backsight; reverse to the foresight. Multiple “sets” may be selected--e.g., two or four sets might be turned on a Third-Order traverse.
- Repeating - multiple angles (windings) are taken to determine each horizontal angle. The value of the circle angle from each foresight reading is used as the circle angle for the next backsight; thus, accumulating the readings.

a. Vertical angles. Similar options are available for vertical angles (or zenith distances). Either a single zenith distance is observed, or multiple (repeated) sets are observed in both circle faces. The number of positions (sets) is a function of the accuracy required. For topographic sideshots, a single zenith distance is all that is necessary. Multiple zenith distances (in face right and face left) should be observed when running a traverse with long distances between setups.

b. Distance measurements. On most data collectors, options are available to take either single or multiple EDM distances. Multiple distances are then averaged for each shot.

c. Tolerance alarms. When multiple sets are observed, a tolerance can be specified in the data collector to alert high misclosures in angles or distances. A tolerance factor on reflectorless observations will indicate potential erroneous settings or poor reflectivity at the target.

d. Traverse procedures. Total station data collectors will automatically update traverse angle and distance observations at each sequential setup. Most collectors will compute angular and position misclosures, and perform a simple (Compass) traverse adjustment. More sophisticated data collectors can perform rigorous least squares adjustments, including vertical network adjustments. Adjusted traverse points are stored for use in densifying topography by radial methods.

8-10. Total Station Leveling Field Procedures

Accurate trigonometric leveling is perhaps one of the most important applications of a total station. Trigonometric leveling error sources must be considered when using a total station to set vertical control or to define feature elevations. Table 8-1 below depicts relative elevation errors over varying distances and differing total station angular accuracies. Knowledge of the limitations of trigonometric leveling, together with means (instrumentation and procedures) to account for such limitations, is essential. Over short lines, total station trigonometric leveling can approach accuracies similar to those reached using a spirit level. Third-Order accuracy can be achieved over short lines, as indicated in Table 8-1 below.

Table 8-1. Elevation Errors (in feet) due to Errors in Trigonometric Zenith Angles

Sight Distance	Vertical Angle Uncertainty (seconds)			
	1 Sec	5 Sec	10 Sec	60 Sec
100 ft	0.0005 ft	0.0024 ft	0.005 ft	0.03 ft
200	0.0010	0.0048	0.010	0.06
400	0.0019	0.0097	0.019	0.12
500	0.0024	0.0121	0.024	0.15
1,000	0.0048	0.0242	0.049	0.29

To obtain Third-Order vertical accuracies with a total station, the following field procedures should be rigorously followed:

- Careful setup and leveling
- Use Face I and Face II observations
- Reciprocal measurements
- Take multiple observations
- Protect instrument from sun and wind
- Use proper targetry based on Inst/EDM configuration
 - Tilting target if necessary
 - Good quality reflectors
 - Correct prism offsets
 - Unambiguous target
 - Maintain targetry in good adjustment
- Limited sight distances
 - 300 meters max
 - Reduce atmospheric-related error
 - Improves vertical angle accuracy
- Accurately measure temperature and pressure
 - At least twice a day
 - If long steep line measurements at both ends, use averages
- Watch for adverse refraction

The following error sources impact the accuracy of trigonometric leveling with electronic total stations:

- Instrument
 - Distances
 - Vertical angle accuracy
 - Vertical compensator important, dual axis compensation
 - No boost to vertical angle accuracy
- Nature
 - Curvature and refraction
 - Temperature/pressure correction
 - Wind, sun, and weather

- Operator
 - Accurate pointing
 - Lots of measurements
 - Reciprocal measurements
 - Measure HI and HT or HR

Errors due to curvature and refraction can become significant at distances greater than 500 ft. At 1,000 ft, a 0.02 ft error due to curvature and refraction is possible. At one mile, a 0.6 ft error results. An approximate formula used to correct for curvature and refraction was shown at Equation 3-7 in Chapter 3.

$$h \text{ (feet)} = 0.0206 (F)^2 \tag{Eq 8-1}$$

where

h = combined correction for curvature and refraction in feet
 F = length of observed line in thousands of feet

Data collectors should have built in options for making the above correction for each shot taken. Table 8-2 below shows the precision resulting from horizontal distance and vertical angular measurements as needed to resolve differences in elevations from trigonometric observation.

Table 8-2.
Combining Sources of Error over a 500-foot line

Errors in Vertical Angle Measurement

Source	Type	Nominal Amount
Instrument accuracy	Random	+/- 3 sec
Collimation	Systematic	+/- 3 sec
Measure HI and HT	Random	+/- 0.005 to 0.1 ft
C and R	Systematic	+/- 0.005 ft
Hand-held prism pole	Random	+/- 0.005 ft
30-mm prism offs error	Random	+/- 3 mm
Heat waves	Random	+/- 0.01 ft
Unshaded instrument	Random	+/- 5 to 10 sec

Combined angular and linear error is between -0.024 ft and 0.048 ft.
 Vertical angle precision for the 500-ft line is therefore in the range 1:10,000 and 1:210,000.

Errors in Distance Measurement

Source	Type	Nominal Amount
Nominal accuracy	Random	+/- (5 mm + 5 ppm)
Temp estimation	Random	+/- 10 degrees F
Pressure estimation	Random	+/- 0.5 in Hg
Prism and instr cal.	Systematic	+/- 2 mm
Prism mispointing	Random	+/- 0.35 mm
Hand-held prism pole	Random	+/- 5 ft (fore/ft lean)

Combined error is between -0.0414 ft and +0.0546 ft.
 On this 500-ft line, this gives a range in precision of 1:9,000 to 1:12,000.

The following guidance from the Oregon Department of Transportation's Geometrics Unit (Oregon DOT 2000) applies to trigonometric elevation observations:

- Due to the effects of curvature and refraction, the instrument to target distance must be kept relatively short. A good rule of thumb is not to exceed 1000 feet.
- Make sure you understand your equipment's capabilities. Instruments that can measure zenith angles and slope distances to a high order of accuracy will produce good trigonometric elevations.
- Setup and level your instrument and target carefully. Measure the height of instrument and height of target accurately.
- Measure several slope distances and use a representative or mean value. Make sure that your EDM is correcting for the appropriate atmospheric conditions.
- Measure direct and reverse zenith angles, and use the adjusted value for your calculations.
- For lines longer than 500 feet, correct for curvature and refraction.

8-11. Positioning Topographic Features with a Total Station

Topographic features are usually cut in by multiple radial sideshots from a primary project control point. This is usually a straightforward process: the remote point is occupied with the prism pole, the HR and feature (code) recorded, and the angle and slope distance observed and recorded. If necessary, supplemental feature attributes may be added. The process is similar when using a reflectorless total station or robotic total station where the data collector is at the prism pole. The following sideshot sequence for the TDS-48GX is typical of most total stations:

DIRECT SIDE SHOTS:

- => P-SHF "MAIN"
 - => enter "J" [trav/side shot]
 - => enter "HR" [height of reflector ... eg "5.0"]
 - => SIDES (measures side shot point)
 - => enter side shot descriptor plus attributes
eg "CTR TWR GRD" "TOP OF TWR"
 - => press ENTER
 - => [repeat for additional side shots]
-

The following Figure 8-7 shows 305 radial total station observations made during a survey at Fort McCoy by the Louisville District. These terrestrial radial observations are in green. Each of the five occupied points was established by fast static GPS observations from the local NSRS point on the installation--a point about a half mile to the north as shown in the lower left insert box on the TGO plate. In addition to the radial total station observations, some 106 RTK topographic points were shot on the easterly side of the site--as indicated in blue radials from the primary GPS base station.

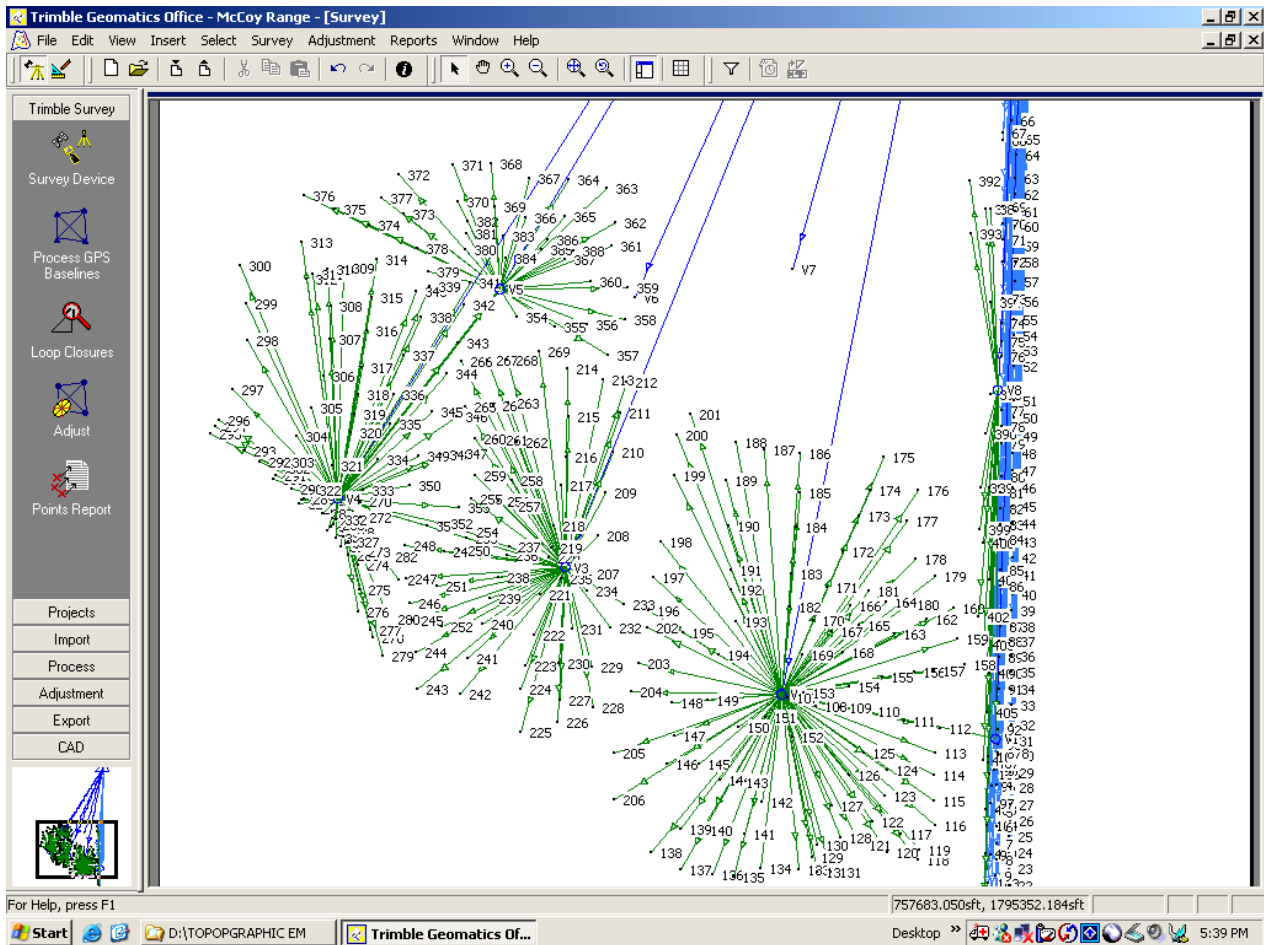

Figure 8-7. Direct radial side shots with a Total Station and RTK control surveys at Fort McCoy Range

a. *Off center sideshots.* Quite often objects cannot be directly occupied with a prism pole or targeted with a reflectorless total station. Off center (or eccentric) corrections are automatically available in most data collectors to cover these situations. Offset cases include trees or circular tanks where only a point on the circumference can be sighted, high objects that are beyond the reach of a prism pole, or invert elevations. The following off center options taken from the TDS-48GX data collector are typical of most data collectors.

The "Off Center Shot Menu" covers five common situations that are encountered in the field when it is not convenient or not possible for the rod to occupy the point that needs to be stored. Those five situations are selected from the Off Center Shot menu. The Offset routines require that the data is collected as Zenith angles and Slope distances. The Traverse / sideshot screen will be automatically set to this mode when an offset shot routine is used.

HORIZONTAL ANGLE OFFSET SCREEN

This screen allows you to shoot the center of a large object such as a big tree.

HORIZONTAL DISTANCE OFFSET SCREEN

The Horizontal Distance Offset routine allows you to collect a point that is in-line with the rod but on which the rodman cannot occupy; e.g., the middle of a river. To use this routine, place the rod in line

with where the point should be placed. Shoot to the rod and enter the distance to add to the measured slope distance. Enter a negative distance to subtract from the slope distance.

VERTICAL ANGLE OFFSET SCREEN

The purpose of the Vertical Angle Offset Screen is to allow you to store a point that is too high for the rod; e.g., the cross-member of a power pole. This routine is used by placing the rod directly above or below the desired point and shooting the rod. Then, move the scope up or down to sight the true point, and press [ZEN] key to read the zenith angle.

RIGHT ANGLE OFFSET SCREEN

The Right Angle Offset Screen allows you to shoot a point that is at a right angle to your rod position; e.g., around the corner of a building. Place the rod at a 90° offset to the point you want to store. Shoot the rod and enter the offset distance. From the Instrument man's point of view, enter + for offsets to the right of the rod and - for offsets to the left of the rod.

VERTICAL DISTANCE OFFSET SCREEN

The purpose of the Vertical Distance Offset Screen is to allow you to collect data for a point that you cannot obtain the zenith angle on, but to which you can measure the vertical distance; e.g., down a manhole. Place the rod above or below the desired point and shoot the rod. Then enter the distance to the actual point: + for up and - for down.

b. *Horizontal distance offset example.* The following is an example of applying a horizontal offset to a target. In this example, the target is a Leica GPS antenna mounted in a tribrach atop a tripod--see sketch at Figure 8-8. The antenna is set over a PK nail marked point. The Total station sights and measures a slope distance to the outside horizontal edge of the antenna--to a point horizontal with the antenna phase center. From published measurements of the GPS antenna, the distance from the outside of the antenna to the phase center is 0.330 feet. This is the offset distance entered into the data collector--a positive value since the offset must be added to the measured slope distance. The following sequence is used to perform a horizontal offset measurement on the TDS 48GX:

HORIZONTAL DISTANCE OFFSET:

- => P-SHF "HDOFF"
- => enter offset distance ... eg radius of cir object [*+0.330 ft" for Leica antenna*]
- => CNTR [*takes shot at center face of object & adds offset*]
- => ENTER
- => enter side shot description [*eg "CENTER OF TANK" CTR TWR" "PK_NAIL"*]

The following data collector string illustrates the raw data saved for a horizontal offset distance sequence--in this example a +0.330 ft offset. The second line in the string is the initial shot on the edge of the antenna. The horizontal angle is zero since this is the backsight for a default local coordinate system with the instrument set at 5,000-5,000-100. The fourth line ("SS") is the offset corrected zenith distance and slope distance to the center of the antenna. Both the zenith distance and slope distance are larger to account for the offset. The last line (Sideshot 2) is the solved coordinates for the center of the GPS antenna at the station mark (a PK nail)

```
-- HD offset
OF,AR0.0000,ZE89.3505,SD47.427  initial horiz angle, zenith dir, & slope distance
OF,DD0.330                       horizontal offset distance of 0.330 feet
SS,OP1,FP2,AR0.00000,ZE89.35153,SD47.757,--PK NAIL  offseted sideshot to Point 2

2, 5047.755754, 5000.000000, 100.053746, PK NAIL solved coordinates Point 2
```

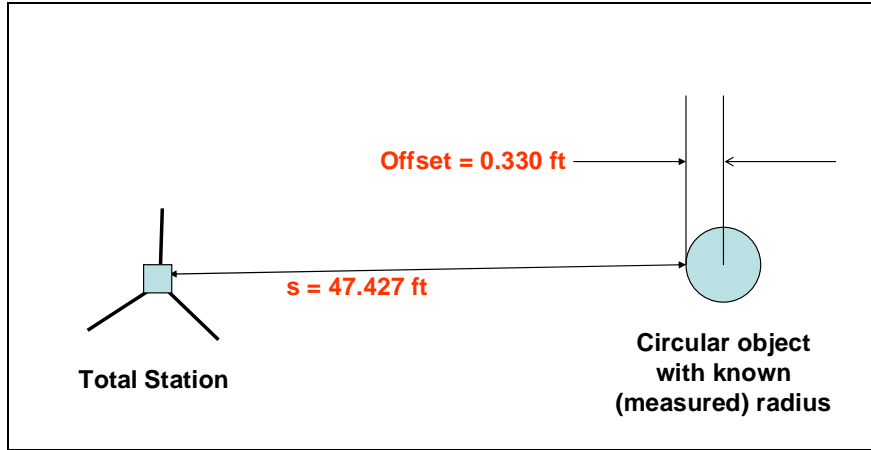



Figure 8-8. Horizontal distance offset measurement to circular object (pole, tree, tank)

c. *Vertical angle offset measurement.* The following is an example of observing a vertical angle offset. In this example, a reflectorless total station is attempting to measure the elevation at the top of a 640-ft antenna--see sketch at Figure 8-9. Since this distance is beyond the range of the reflectorless return, or the object at the top does not provide sufficient reflectivity, an offset angle observation is required to obtain the elevation. The following sequence is used to perform a vertical angle offset measurement on the TDS 48GX:

VERTICAL ANGLE OFFSET SHOTS:

- => P-SHF "VAOFF"
- => (sight reflector or reflectorless return point at bottom of object)
- => CNTR (measures)
- => (sight top of antenna)
- => ZEN (computes elev of top)

In the example TDS-48GX raw data string below, the total station is set over an arbitrary coordinate point ("PK_NS-1"-10,000 ft-10,000 ft-100 ft), with an HI = 5.39 ft. An intermediate point on the tower directly below the highest-most point is selected at which a reflectorless slope distance can be made. On the second line of the string below, observations to the intermediate point are: horizontal angle right (AR) of 338° 00' 40", zenith distance of 31° 39' 30", and a slope distance of 329.52 ft. The instrument is then elevated to point on the top of the antenna--a zenith distance of 15° 14' 35" is observed. (For such a high vertical angle, a 90-degree solar prism is needed for the eyepiece). The final corrected "SS" line has computed the slope distance as 657.81 ft to the top of the antenna, and the solved X-Y-Z coordinates of the antenna are shown in the last line. The elevation of the antenna is 640.06 ft above the elevation of the total station point (assumed elevation 100.0 ft).

```
OC,OP1,N 10000.0,E 10000.0,EL100.0,--PK_NS-1 ... LS,HI5.39
OF,AR338.0040,ZE31.3930,SD329.520659
OF,ZE15.1435,--Vert Angle Offset
SS,OP1,FP11,AR338.0040,ZE15.1435,SD657.818349,--TOP ANTENNA
11,10160.3689,9935.2429,740.0658, TOP ANTENNA  solved elevation
```

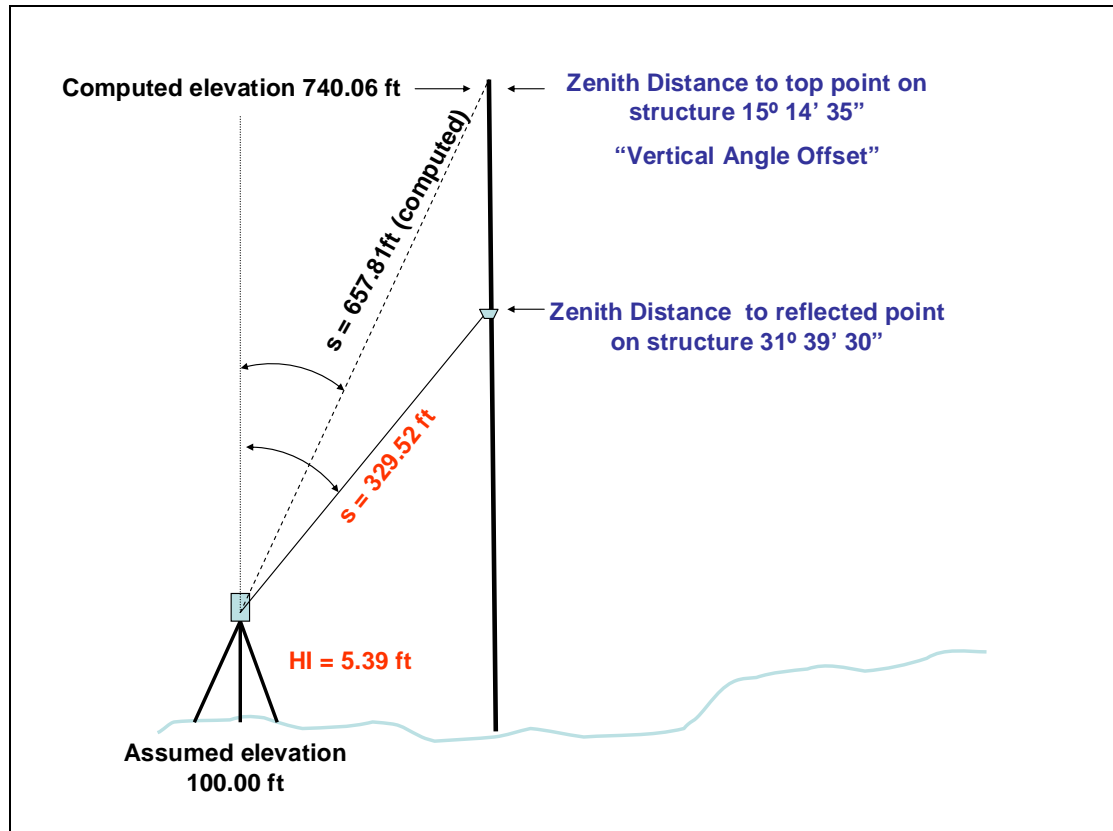

Figure 8-9. Vertical Angle Offset

Chapter 9 GPS Real Time Kinematic Topographic Survey Procedures

9-1. Purpose and Scope

This chapter provides guidance on the use of GPS Real-Time Kinematic (RTK) positioning methods for performing topographic surveys of terrain, facilities, and infrastructure. RTK and total station methods provide identical output coordinate data. The only difference is that a total station must perform a visual observation from a reference station to some remote point to obtain a coordinate, whereas an RTK system derives the coordinates of the remote point by reducing carrier phase data over a GPS baseline between the reference (base) station and the remote point. The RTK base/reference point need not be visible and may be miles distant from the project site. Both systems employ similar (or identical) data collector devices, feature coding, attribution of features, stakeout methods, COGO functions, etc. Some data collectors (e.g., the Trimble TSC) can be connected to either a total station or a GPS receiver for RTK operation. Thus, this chapter will cover only those RTK survey functions that are unique to real-time GPS surveying--the standard data collector and COGO functions covered in previous chapters will not be repeated. Only detailed site plan mapping applications with RTK will be covered. EM 1110-1-1003 (*NAVSTAR GPS Surveying*) should be consulted for small-scale “mapping grade” GPS applications and procedures, such as use of meter-level positioning systems for GIS mapping. Some of the material in this chapter is taken from applicable sections on RTK surveying in EM 1110-1-1003. This GPS manual should be consulted for the basic theory and principles of GPS (and RTK) surveying. An example of an RTK topographic survey of a Corps project is shown in Appendix D of EM 1110-1-1003--“*Application: Dredge Material Disposal Area RTK Cross-Sections-(Jacksonville District)*.” Additional examples of RTK surveys are provided in appendices to this manual--see Appendix J: “*Application: Topographic Survey for Proposed US Army Reserve Center Belaire, Belmont County, Ohio (Louisville District)*.”



Figure 9-1. Real-Time kinematic survey of Corps lock and dam project--hand-held fixed height antenna pole

9-2. RTK Field Techniques

Unlike GPS static survey methods used for precise control surveys (Figure 9-2 below), RTK methods provide real-time positioning results; thus, it can be used like a total station for real-time construction stakeout, setting project control, or topographic mapping. To obtain real-time coordinates at a remote ("rover") point, a communication link (radio, cell phone, or satellite) is required between the reference base station and the roving receiver. The remote/rover receiver is mounted on a range pole, similar to a prism pole for a total station. The operator at the remote receiver performs all survey and data collection functions at that point (the reference station is unattended). Thus, one-man survey crew operation is feasible if the reference station can be placed in a secure location. RTK surveying requires both the reference and remote receivers simultaneously recording observations. Periodic losses of the communication link can also be tolerated and/or corrected for in post-processing (e.g., PPRTK solutions). Unlike total station shot methods, the RTK rover receiver can be continuously moving--used for marking linear continuous features. RTK surveys require dual-frequency (L1/L2) GPS observations.



Figure 9-2. Static or Fast-Static survey techniques. Rover is set on a tripod accurately centered over a control point or feature such as a photo target. 5 minutes to 2 hours of static data may be collected whereas an RTK solution may have only a few seconds using a hand-held antenna pole.

a. Ambiguity resolution. Carrier phase integer ambiguity resolution is required for successful RTK baseline formulations. A fixed solution is essential for RTK surveys--float solutions over short distances are not accurate enough for engineering surveys. RTK surveys can be initialized at a known point. However, most systems employ "on-the-fly" (OTF) initialization technology, where the remote receiver can initialize and resolve integers without a period of static initialization. With OTF capability, if loss of satellite lock occurs, initialization can occur while in motion. OTF integers can usually be resolved at the rover within 10-30 seconds, depending on the distance from the reference station. This initialization is automatically performed by the survey controller device. OTF makes use of the L2 frequency in

resolving the integer ambiguity. A minimum of 5 satellites are required for OTF initialization, and after initialization, at least 4 satellites must be tracked. After the integers are resolved, only the L1 C/A is used to compute the positions. If no OTF capability is available, then initialization should be made at a known point and 4 satellites must be kept in view at all times and loss of satellite lock would require reinitialization. For QA purposes, OTF initialization may be made at a known location (control monument).

b. Survey procedure. Like the total station, RTK surveys are performed in a radial manner about a base station--see Figure 9-3 below. One of the GPS receivers is set over a known point (base station) and the other is placed on a moving or roving platform. The survey controller will determine the amount of time required to lock in over each remote point. If the survey is performed in real-time, a data link and a processor (external or internal) are needed. The data link is used to transfer the raw data from the reference station to the remote. If the radio link is lost, then post-processing techniques (PPRTK) are available to compute the survey, such as Trimble's "Infill" option, provided the raw GPS observations are collected during the survey. Since most unlicensed radio frequencies have limited range (one mile \pm), booster or repeater stations may be used if the job site is large. Alternatively, multiple base stations may be set up to extend coverage. Networked "virtual reference stations" are also available in some areas, allowing extended RTK coverage using cell phone modems in addition to adjusted solutions from the multiple bases.

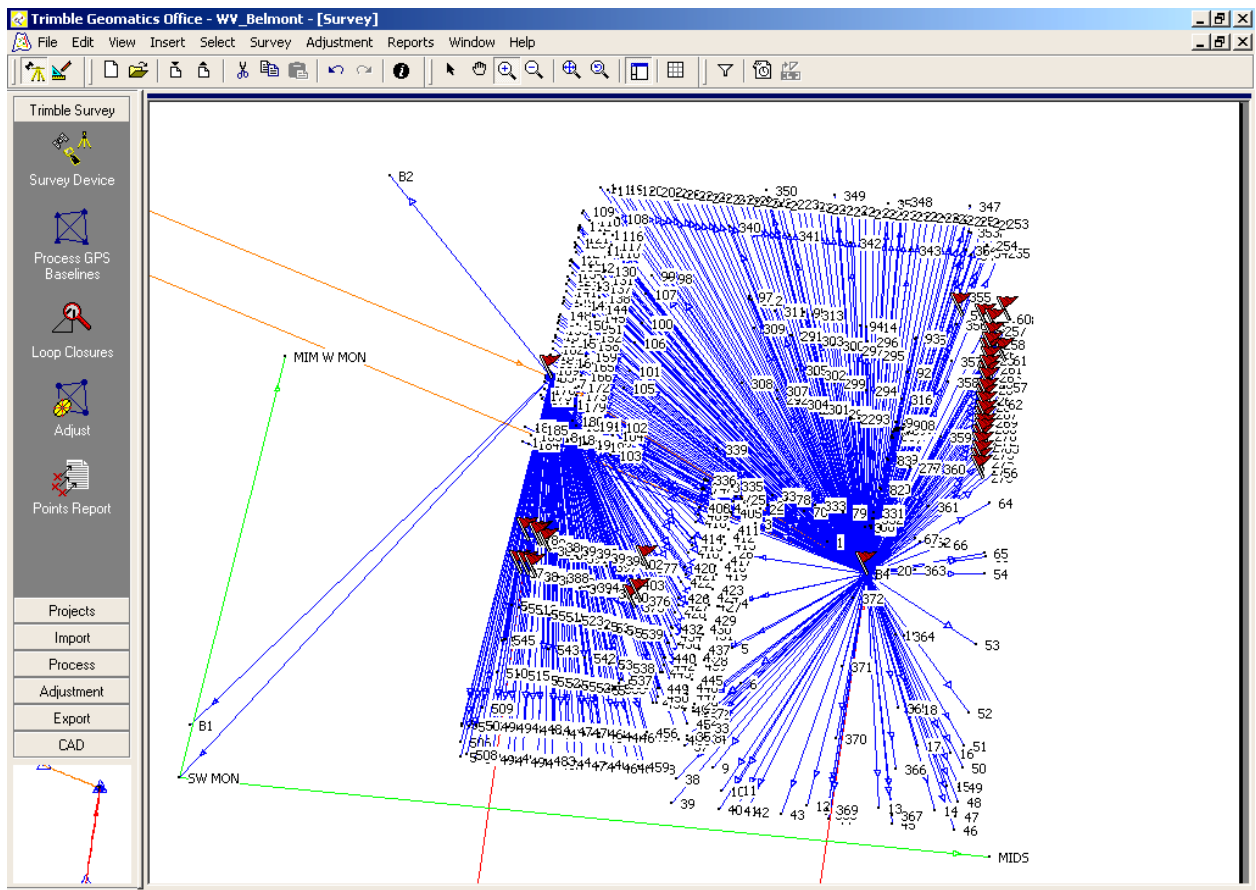

Figure 9-3. RTK Radial Survey Method--Proposed USARC, Belmont Co., Ohio (Louisville District)

c. Accuracy of RTK surveys. RTK surveys are accurate to within 3-10 cm (in 3D) when the distance from the reference to the rover does not exceed 10 k. Expected 3D accuracies over short

distances (less than one mile from reference base) are typically around the 0.1 ft range; provided that a good site calibration has been performed--see section 9-4.

d. General data collection operation. The following functions are required to perform an RTK survey.

- Set up horizontal and vertical projection grid
- Establish coordinates of reference point
- Configure reference and rover hardware
- Establish radio link between reference and rover
- Collect coordinate data at fixed monuments and benchmarks around survey site
- Perform site calibration (or localization) with appropriate geoid model (see section 9-4)
- Perform topographic or stakeout measurements--store points with descriptors and attributes

Some of the above items will be covered in the following sections. They are covered in greater detail in the GPS receiver operation or reference manuals (e.g., Trimble 2001), or in training courses developed for specific receivers and/or RTK data collectors (e.g., “*Survey Pro for Window CE--GPS RTK Training Guide*”).

e. Receiver set up. Figure 9-4 below depicts the set up configuration for a GPS rover receiver, as set up for RTK surveys. The radio link component must be set for maximum distance--and repeaters added if surveying a large site. Different channels may need to be tested to avoid interference. Once the system is set up and activated, the base station receiver must be initialized with the coordinates (and datum) of the point over which it is set. The rover receiver is then activated and initialized at a known point or by OTF methods.

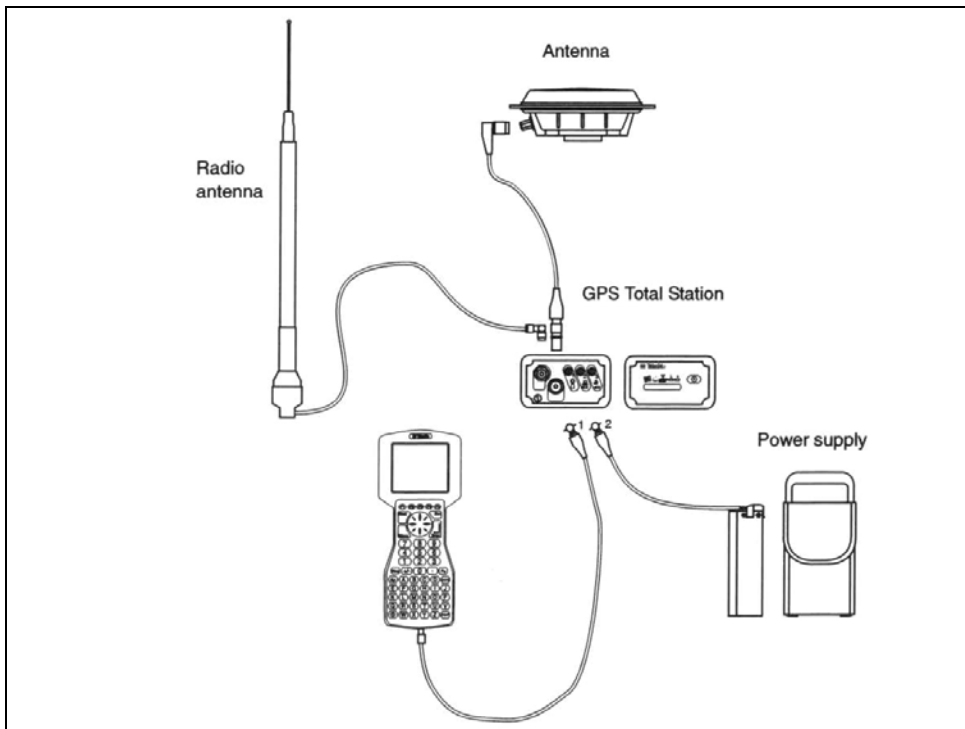

Figure 9-4. Rover GPS receiver setup for RTK surveys--Trimble Navigation LTD



Reference (Base) Station



Remote (Rover) Station

Figure 9-5. Trimble RTK survey system (David Evans & Associates, Inc)

9-3. Standard RTK Observing Procedures

The following guidance is excerpted from Woolpert, Inc. published instructions to their field survey personnel, many of whom work on Corps projects. These instructional procedures are representative of quality control and quality assurance checklists that should be developed and used by field personnel.

RTK Survey Standard Operating Procedures (Woolpert, Inc.)

BASE STATION SETUPS:

- Place base station in clear, open, location--360 deg clear sky >10 degs
- Use Ground-plane (GP) on all base station setups
- Completely fill out base station log sheet
- RECORD BASE STATION DATA – use RTK-Infill on base station receivers
- When working from known/fixed coordinates, double-check to ensure that coordinates have been entered correctly
- Ensure that both primary and backup batteries are fully charged
- Base station equipment needs a listing of licensed radio freq.

EQUIPMENT MANAGEMENT:

- When equipment is received from a different office or was last used at a distant location from current, reset/reboot receiver (See operation manual for details)
- Be aware of battery power capacity before beginning survey – CHARGE BATTERIES the night before!
- Check and adjust plum on all FH-tripods and rover staffs prior to the start of every survey
- Keep cables and hardware clean and in operation
- Always carry a spare antenna cable.
- Keep all equipment and cables in protective cases

ROVERS PROCEDURES:

- Initialize the equipment in clear, open location
- Check into a minimum of 2 control points as frequently as possible throughout the duration of survey
- Set PDOP mask @ 5.0
- Set SV Elevation mask @: 15 degrees

SITE CALIBRATION:

- A minimum of **four (4)** 3D local grid coordinates and **four (4)** WGS-84 coordinates must be used to complete a site calibration
- A survey consisting of conventional measurements only **do not** require a site calibration
- Extremely important! Do not conduct survey outside the polygon you create from the calibration
- Points in Site Calibration NTE a residual tolerance of:
 - Stake-out & Control: 0.10 sft
 - Topo & Reconnaissance: 0.15 sft

SETTING UP SURVEY CONTROLLER PROJECT

1. Prior to field work, perform GPS Skyplot with most recent ephemeris file available
2. From main menu, select *Files*
3. Select *New Job*
4. Enter the job name in the *Name* field
5. In the Select coordinate system field, select a coordinate system option
 - ▶ Select from library – uses a list of pre-defined coordinate systems saved on device
 - ▶ Key in parameters – allows user to import the projection and transformation parameters
 - ▶ Scale factor only – uses a coordinate system based on scale factor only, enter scale factor
 - ▶ Copy from other job – allows user to use coordinate system previously defined in other project
 - ▶ No projection/No datum – selects a coordinate system with an undefined projection and datum
6. Link background files (i.e.: *.dxf) by tapping *Background File* button
7. Link control point coordinate files (i.e.: *.csv) by tapping *Control File* button
8. Open the job by highlighting the job's name and tapping Enter

SITE CALIBRATION PROCEDURES

A site calibration combines GPS measurements and conventional measurements with local coordinate system control points!!

1. Check or enter the calibration tolerances
2. Use the RTK to observe and measure a minimum of 4 control points

- A. GPS control points that have local grid coordinates
- B. Name the GPS point differently (but similar) to the local grid point names i.e.: Grid Point Name = 100 _ WGS-84 Point Name = 100_GPS

3. Perform site calibration operation:

- A. From main menu, choose *Survey*
- B. Choose *Site Calibration*
- C. Tap **Add** button
- D. In the Grid Point Name box, enter a local grid point name _ In the GPS Point Name box, enter the GPS point name associated to the local point name
- E. Choose the type of calibration to be used (Horz & Vert, Horz, or Vert)
- F. The results screen appears showing residuals once 3 horizontal points or 4 vertical points are entered
- G. Tap **ESC** to return to the calibration screen
- H. Enter all control observed following steps C. thru E.
- I. When finished entering all control points, tap **Apply** to store the calibration, or recalculate if residuals are not acceptable
- J. If *Auto calibrate* is checked, Survey Controller will automatically continue to calculate calibration as more control points are observed

TRAVERSE & CONTROL SURVEY

PROCEDURES

- All new control points set for the purpose of traverse, base station or other control needs are required to be observed at least twice during different satellite constellations (at least one hour time separation between observations)
- Use of multiple base stations are required for redundancy, data postprocessing, and provides the possibility to perform a least-squares adjustment to data
 - It is recommended that static GPS procedures be employed when establishing:

1. Prior to field work, perform GPS Skyplot with most recent ephemeris file available
2. Set base station location--either set new point or use existing control
3. Assemble base station equipment
4. Connect ACU, TSC1 or TSCe data collectors to setup
5. Power up base system
6. Start base station survey in Survey Controller - Survey Style: RTK INFILL
7. Check setup for faulty operation of receiver, radio and cables
8. Disconnect data collector from setup
9. Assemble rover equipment with data collector attached
10. Power up rover system
11. Check setup for faulty operation of receiver, radio and cables
12. Proceed to and check into control point(s) previously established
13. Begin observations of points set as traverse points using CONTROL POINT survey – 3 minute observation (180 sec)
14. If survey spans more than 2 hours in length, a random check should be made on nearby control
15. End the survey by checking into control point(s) previously established
16. Complete second pass through all control and all traverse points, repeating steps 11 thru 14 at every point during a different satellite constellation
17. Connect data collector to base station setup and End Survey

TOPOGRAPHIC SURVEY PROCEDURES

All new control points are required to be observed at least twice during different satellite constellations (at least one hour time separation between observations)

1. Begin topographic observations while observing proper topo-survey techniques and feature coding – each point a minimum of a 5 second observation (5 sec)
2. If survey spans more than 2 hours in length, a random check should be made on nearby control.

9-4. Site Calibration

A site calibration (also called a localization) must be performed before conducting a RTK survey. This is because the local georeferenced coordinate system is not planer with the GPS ellipsoid system. For example, a given project site may be on local NAD 83 horizontal coordinates and have a NGVD 29 vertical datum; RTK satellite observations are on the WGS 84 ellipsoid. A site calibration “best fits” horizontal and vertical variances (undulations) such that observed GPS positions on the ellipsoid are corrected to best fit the local datum at points within the site. Calibration of vertical geoid undulations is especially critical when RTK techniques are used for topographic ground shots or vertical stakeout. A calibration is needed in real-time kinematic surveying in order to relate GPS positions that are measured in terms of WGS-84 to local grid coordinate projections, such as SPCS, UTM, or a local station-offset-elevation system. In addition, a vertical calibration is needed to adjust the observed GPS ellipsoid elevations to a local vertical datum, and account for undulations in the local geoid over the project area. A calibration should be used on a project whenever new points are to be established. A calibration is based on a set of points that have 3D coordinates in both WGS-84 and the local grid coordinate projection system. The quality of the calibration will be affected by the accuracy and consistency of the GPS-derived coordinates of the points. Points tied to the NSRS are recommended as the basis of a calibration. The number of points that can be used in a calibration is manufacturer and software dependent. Smaller sized projects may be calibrated with one 3D point. However, for larger sized projects, three or four 3-D points are recommended. Calibration points should be well distributed around the project exterior. Projects may be calibrated by two methods: (1) in the field in the survey data collector or (2) in the network adjustment. The later procedure is recommended for large projects. The calibration computation summary should be examined for reasonable results in the horizontal scale, maximum vertical adjustment inclination, and the maximum horizontal and vertical residuals.

a. Figure 9-6 below illustrates the varied requirements for vertical site calibrations. This figure depicts a typical contour plot of a geoid model--height differences between the geoid relative to the WGS 84 ellipsoid. In the large (8 km x 8 km) Area A, the geoid undulation varies from 0.80 m to 1.27 m--nearly a 50 cm variation. In order to determine accurate orthometric elevations from GPS ellipsoid elevation observations, this variation in the geoid must be accurately accounted for. In addition, the published orthometric elevations at each of the 7 established control benchmarks may not fit exactly with the geoid model--the geoid model may have been approximated from other NSRS points. Therefore, GPS observations over the 7 established control network points must be adjusted to further refine the geoid model so that subsequent GPS observations to any point in the project area can be "best-fitted" to the local vertical datum. Solely relying on a published geoid model is not recommended--connections with existing control should always be observed to refine the model. GPS adjustment software must be able to compensate for both the variations in the geoid model and variations in the established control benchmarks. In order to accomplish this, GPS observations need to be connected between the fixed control benchmarks, as shown in Area A.

b. The small (1 km x 1 km) Area B in Figure 9-6 below is more typical of local RTK topographic survey projects. The geoid model shows a minimal undulation over this area--from 0.72 m to 0.75 m. This 3 cm variation may or may not be significant, depending on the required elevation accuracy of the survey. If this 3 cm geoid variation is not considered significant, then the geoid undulation at the selected reference station could be used over the entire area, and no geoid model correction used. Alternatively, the 2 control benchmarks could be calibrated and the geoid model included in the adjustment. When 2 control benchmarks are available, as shown around Area B, then a GPS check between the benchmarks is recommended. If the geoid model is not used, the geoid correction could be interpolated from the check baseline observation results, holding the 2 control points fixed.

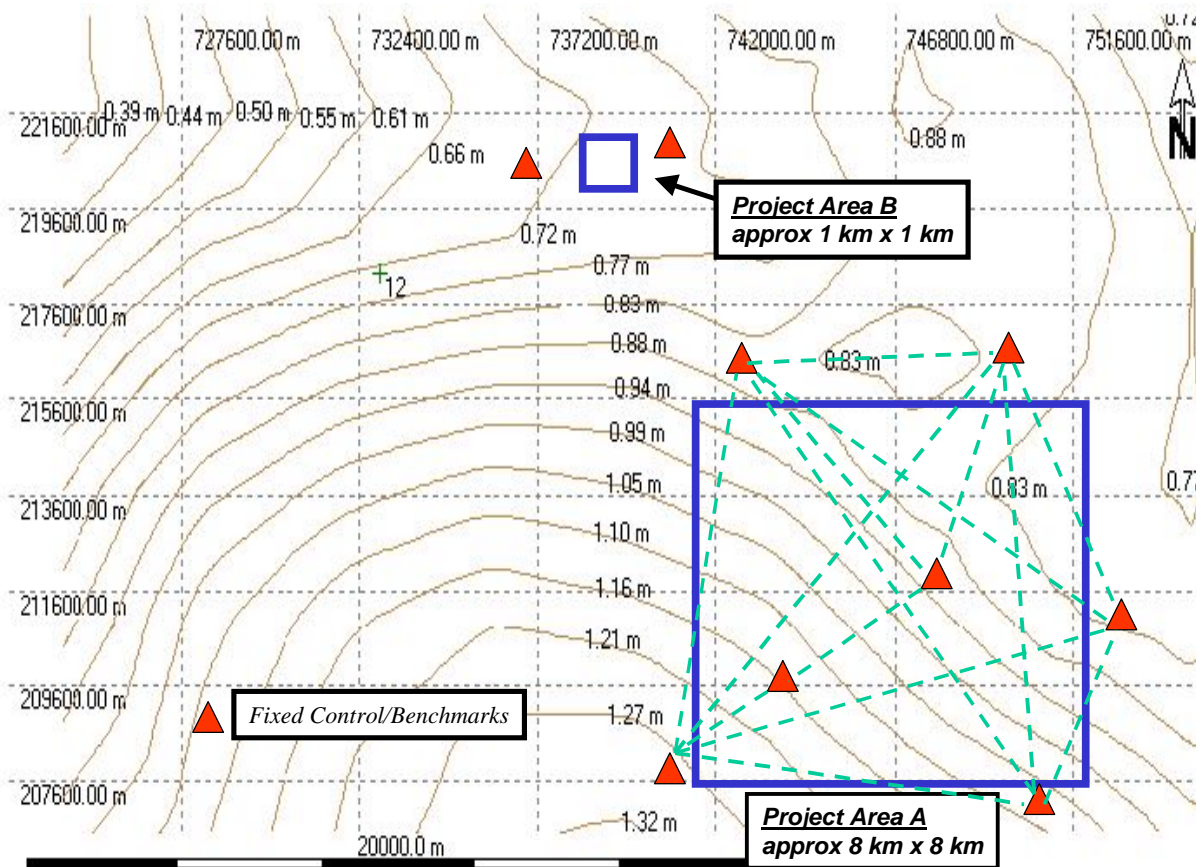

Figure 9-6. Plot of geoid undulation contours over a local survey area (Leica)

c. Figure 9-7 below illustrates vertical calibrations over small local survey areas, which is typical of Corps topographic survey applications. This area contains two fixed benchmarks with local datum elevations. A GPS reference receiver is set up over one benchmark and baseline hubs are staked out relative to this point, using kinematic techniques. The second fixed benchmark is used as a check point. A local geoid model shows estimated geoid heights varying between -11.23 and -11.25 m. Orthometric elevations on the individual baseline hubs are computed by correcting the observed ellipsoidal elevation differences with the local geoid undulation differences. This local geoid elevation difference (- 2 cm) could have been ignored if this error is acceptable to project accuracy requirements. This would, in effect, assume observed ellipsoidal elevation differences are equal to orthometric elevation differences and no geoid model corrections are applied to the observations.

d. In Figure 9-7 below, a check point GPS elevation difference of +12.40 m is observed. The published orthometric elevation difference between these points is +12.42 m. This confirms the geoid model is accurate over this area since the computed geoid undulation difference (ΔN) is - 0.02 m (+12.40 - 12.42). Had a large misclosure existed at the check point, then either the published elevations are inaccurate or the geoid model is inaccurate. A GPS baseline check to a third benchmark would be required, or conventional levels could be run between the two fixed points to resolve the problem.

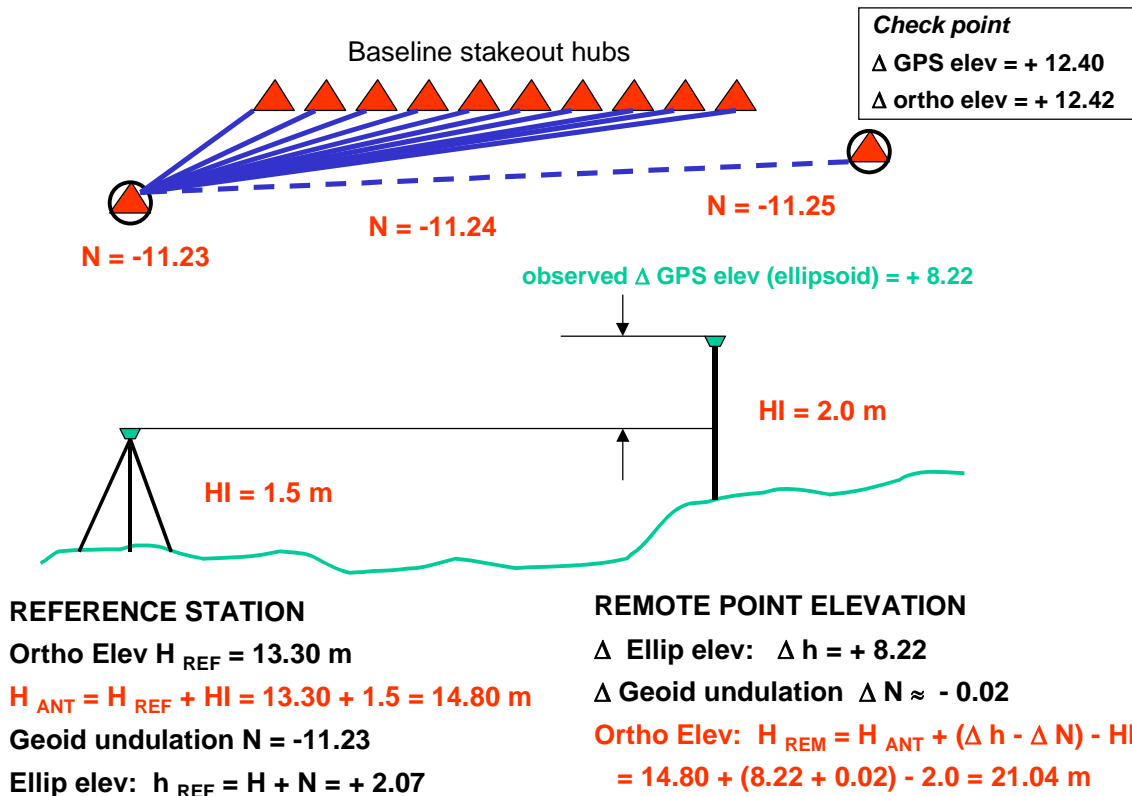

Figure 9-7. Geoid elevation corrections for localized surveys

e. *Manual site calibration procedure (Trimble).* The Trimble Survey Controller Reference manual (Trimble 2001) outlines the following process for performing a site calibration. This procedure is representative of other RTK systems.

- Key in or upload grid coordinates of all the control/calibration points around the project site
- Set calibration tolerances (acceptable adjustment levels)
- Measure the control/calibration points using the GPS/RTK receiver
- Pair local grid coordinates and WGS 84 coordinates for each control/calibration point
- Activate the site calibration routine on the controller
- Check residual errors v tolerances at each control/calibration point ... recheck points and reject as required
- Apply the final site calibration to the controller

f. Examples of site calibrations can be found in operating or training manuals for RTK equipment, e.g., *Real-Time Surveying Workbook* (Trimble) or *Basic GPS Controller Workshop--Survey Pro for Windows CE* (Tripod Data Systems).

9-5. RTK Survey Field Data Collection Procedures and Checks

Once a site calibration has been performed, field data collection (or stakeout) procedures are straightforward, and are detailed in GPS operation/reference manuals. Figure 9-8 below is a Trimble TSC screen display in the “measure point” mode. This screen shows a topographic shot point (TOPO1001) being measured to. The GPS antenna on the rover is set on a fixed-height pole at 2.00 meters. The bottom of the screen displays the number of satellites being observed (5), the estimated errors in the horizontal (0.009 m) and vertical (0.014 m), and that the fixed solution has an RMS of 7. Optional screen displays will provide HDOP, VDOP, and other satellite related information.

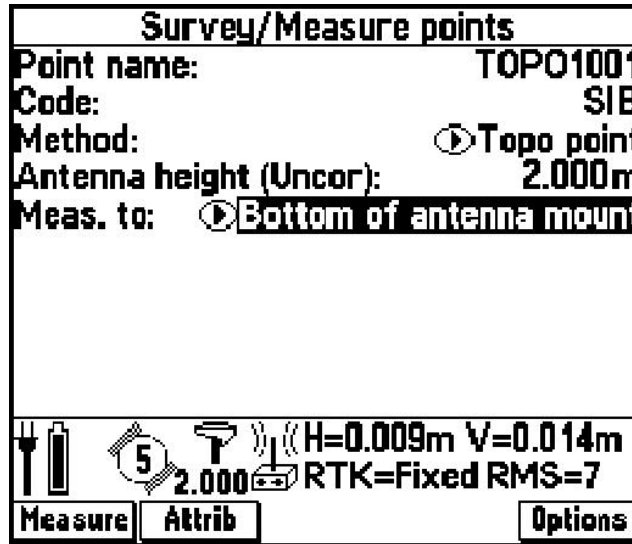

Figure 9-8. Trimble TSC “Measure Points” screen

The USFS and BLM *Standards and Guidelines for Cadastral Surveys* (USFS/BLM 2001) contains guidance for performing RTK surveys that is directly applicable to USACE RTK topographic mapping and construction control surveys. Some of the more significant field procedures recommended by the USFS/BLM are outlined below. These generally reduce down to (1) system checks, (2) measurement procedures, (3) and periodic calibration checks.

a. RTK system check. A RTK system check shall be made prior to any measurements. RTK system checks may also be made at any time during the course of each RTK survey session or at any time the base receiver(s) and rover receiver(s) are set up and initialized per the manufacturer’s recommended procedures. This check is a measurement from the RTK base setup to another known project control monument. The resulting observed position is then compared by inverse to the previously observed position for the known point. This inverse should be within the manufacturer’s recommended values for duplicate point tolerance measurements--typically within ± 2.5 cm in position and within ± 5 cm in elevation. This RTK system check is designed to check the following system parameters:

- The correct reference base station is occupied.
- The GPS antenna height is correctly measured and entered at the base and rover.
- The receiver antennas are plumb over station at base and rover.
- The base coordinates are in the correct datum and plane projections are correct.

- The reference base stations or the remote stations have not been disturbed.
- The radio-communication link is working.
- The RTK system is initialized correctly.
- RMS values are within manufacturer's limits.

b. *RTK measurements.* RTK topographic observations are usually made using one or more base stations and one or more rover receivers. RTK measurements shall be made after the system setup check procedures have been completed. Use manufacturer's recommended observation times for the highest level of accuracy when setting mapping or construction control points, for example, 180 seconds of time or when the horizontal (e.g., 2 cm) and vertical (e.g., 5 cm) precision has been met for a kinematic control point. Under optimal conditions a deviation from the manufactures suggested times is appropriate; for example, a point may be observed using 30 seconds of time and 20 epochs of measurement data. However, observation times should be set to account for field conditions, measurement methods (e.g., Trimble "topo point" or "kinematic control point") and the type of measurement checks being performed. Individual features can be quickly observed, as illustrated in Figure 9-9 below.

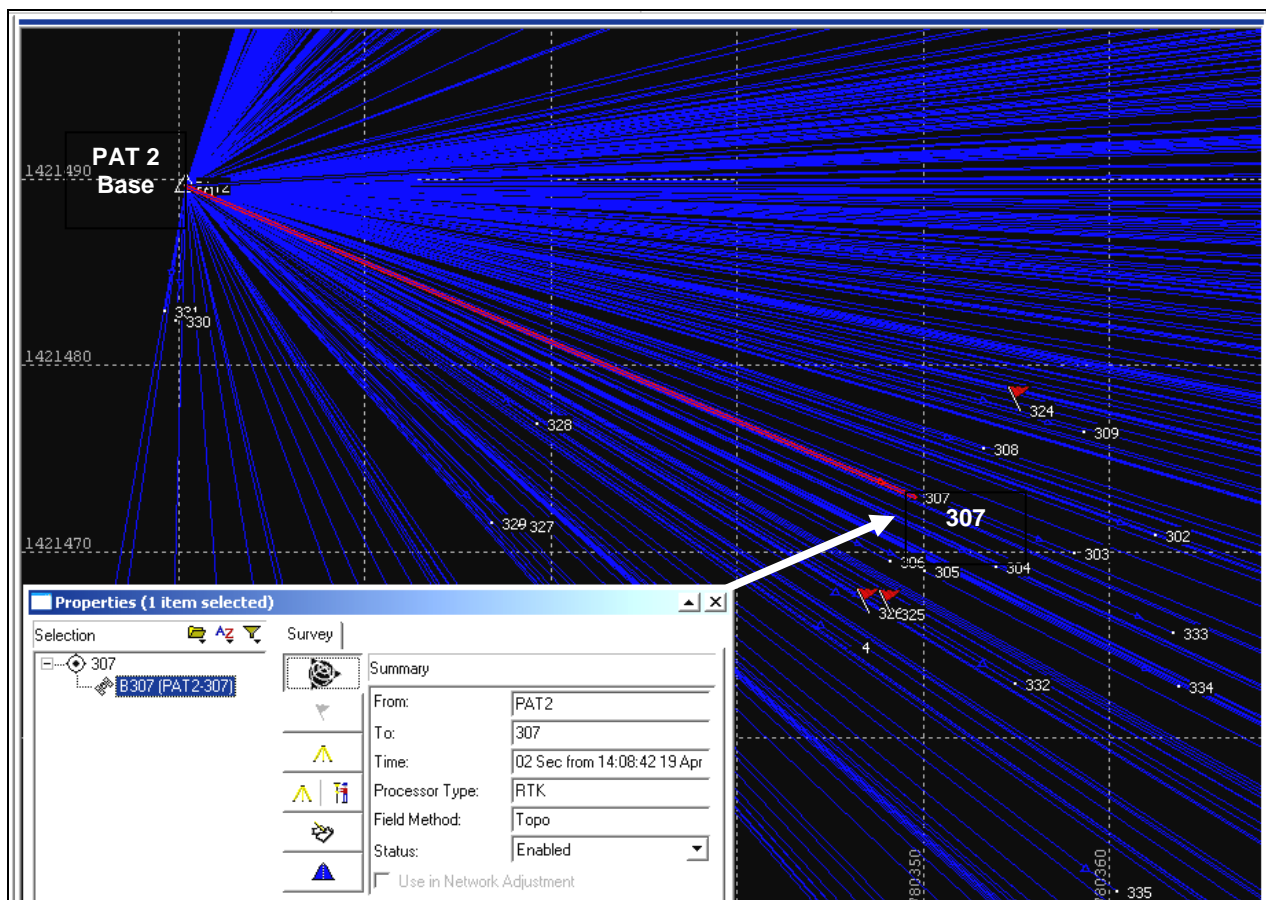

Figure 9-9. Short-term (2-sec) RTK observation on a topographic point--# 307
(Patrick AFB Airfield Surveys--Louisville District)

9-6. Guidance for Setting Construction Control Points Using RTK Techniques

The following general guidance on RTK construction control surveys is taken from the CALTRANS *Surveys Manual*. These procedures will generally meet Third-Order criteria and are applicable to setting control for most construction projects.

RTK survey design:

- *The project area shall be “surrounded” and enclosed with RTK control stations. (See the end of this section for the definition of an RTK control station.)*
- *If the RTK control station is used for horizontal control, the RTK control station shall have horizontal coordinates that are on the same datum and epoch as the datum and epoch required for the project.*
- *If the RTK control station is used for vertical control, the RTK control station shall have a height that is on the same datum as the datum required for the project.*
- *All RTK control stations shall be included in a GPS site calibration. (See the end of this section for the definition of a GPS site calibration.)*
- *If the RTK equipment does not support the use of a GPS site calibration, the RTK control stations shall be used for check shots.*
- *For third order RTK surveys, each new station shall be occupied twice. The 2nd occupation of a new station shall use a different base station location. If the new station is being elevated by RTK methods, the 2nd occupation of the new station shall have a minimum of 3 different satellites in the satellite constellation. This is generally achieved by observing the 2nd occupation at a time of day that is either 4 hours before or 4 hours after the time of day of the 1st occupation.*
- *Establish the new stations in areas where obstructions, electromagnetic fields, radio transmissions, and a multipath environment are minimized.*
- *Use the current geoid model when appropriate.*

Definition: An RTK control station is a station used to control a survey that utilizes RTK methods. The station shall have either horizontal coordinates, a height, or both. The order of accuracy of the horizontal coordinates and the height shall be at least third order.

Definition: A GPS site calibration establishes a relationship between the observed WGS84 coordinates and the known grid coordinates. This relationship is characterized by a translation, rotation, and scale factor for the horizontal coordinates and by an inclined plane for the heights. By applying a GPS site calibration to newly observed stations, local variations in a mapping projection are reduced and more accurate coordinates are produced from the RTK survey.

Note: A GPS site calibration can be produced from RTK observations, an “office calibration,” or from a combination of both. If the RTK control stations were established by static or fast static GPS techniques, then an office calibration may be used. The procedures for an office calibration are:

- *Do a minimally constrained adjustment before normalization holding only one WGS84 latitude, longitude, and ellipsoid height fixed.*
- *The epoch of the fixed values shall correspond to the epoch of the final coordinates of the RTK survey.*
- *Associate the results of this minimally constrained adjustment with the final grid coordinates in a site calibration.*

Satellite Geometry: *Satellite geometry affects both the horizontal coordinates and the heights in GPS/RTK surveys. The satellite geometry factors to be considered for RTK surveys are:*

- Number of common satellites available at the base station and at the rover unit.
- Minimum elevation angle for the satellites (elevation mask).
- Positional Dilution of Precision (PDOP) or Geometric Dilution of Precision (GDOP).
- Vertical Dilution of Precision (VDOP).

Field Procedures: Proper field procedures shall be followed in order to produce an effective RTK survey.

For Third-order RTK Surveys, these procedures shall include:

- It is recommended that the base station occupy an RTK control station with known coordinates for horizontal RTK surveys and known heights for vertical RTK surveys.
- A fixed height tripod shall be used for the base station.
- A fixed height survey rod or a survey rod with locking pins shall be used for the rover pole. A tripod and a tribrach may also be used. If a fixed height survey rod or a survey rod with locking pins is not used, independent antenna height measurements are required at the beginning and ending of each setup and shall be made in both feet and meters. The antenna height measurements shall check to within $\pm 3\text{mm}$ and ± 0.01 feet.
- A bipod/tripod shall be used with the rover unit's survey rod.
- The data transfer link shall be established.
- A minimum of five common satellites shall be observed by the base station and the rover unit(s).
- The rover unit(s) shall be initialized before collecting survey data.
- The initialization shall be a valid checked initialization.
- PDOP shall not exceed 5.
- Data shall be collected only when the root mean square (RMS) is less than 70 millicycles.
- A check shot shall be observed by the rover unit(s) immediately after the base station is set up and before the base station is taken down.
- The GPS site calibration shall have a maximum horizontal residual of 20 mm for each horizontal RTK control station.
- The GPS site calibration shall have a maximum vertical residual of 30 mm for each vertical RTK control station.
- The new stations shall be occupied for a minimum of 30 epochs of collected data.
- The precision of the measurement data shall have a value less than or equal to 10 mm horizontal and 15 mm vertical for each observed station.
- The rover unit(s) shall not be more than 10 km from the base station.
- The 2nd occupation of a new station shall have a maximum difference in coordinates from the 1st occupation of 20 mm.
- The 2nd occupation of a new station shall have a maximum difference in height from the 1st occupation of 40 mm.
- When setting supplemental control by RTK methods for conventional surveys methods, it is recommended that the new control points be a minimum of 300 meters from each other.
- When establishing set-up points for conventional survey methods, set three intervisible points instead of just an "azimuth pair." This allows the conventional surveyor a check shot.)

For general-order RTK surveys, these procedures shall include:

- It is recommended that the base station occupy an RTK control station with known coordinates for horizontal RTK surveys and known heights for vertical RTK surveys.
- Fixed height tripods are recommended for the base station. If fixed height tripods are not used, independent antenna height measurements are required at the beginning and ending of each setup and shall be made in both feet and meters. The antenna height measurements shall check to within $\pm 3\text{ mm}$ and ± 0.01 feet.
- A fixed height survey rod or a survey rod with locking pins shall be used for the rover poles. A tripod and tribrach may also be used. If a fixed height survey rod or a survey rod with locking

pins is not used, independent antenna height measurements are required at the beginning and ending of each setup and shall be made in both feet and meters. The antenna height measurements shall check to within ± 3 mm and ± 0.01 feet.

- *A bipod/tripod shall be used with the rover unit's survey rod.*
- *The data transfer link shall be established.*
- *A minimum of five common satellites shall be observed by the base station and the rover unit(s).*
- *The rover unit(s) shall be initialized before collecting survey data.*
- *The initialization shall be a valid checked initialization.*
- *PDOP shall not exceed 6.*
- *Data shall be collected only when the root mean square (RMS) is less than 70 millicycles.*
- *A check shot shall be observed by the rover unit(s) immediately after the base station is set up and before the base station is taken down.*
- *The GPS site calibration shall have a maximum horizontal residual of 20 mm for each horizontal RTK control station.*
- *The GPS site calibration shall have a maximum vertical residual of 30 mm for each vertical RTK control station.*
- *The precision of the measurement data shall have a value less than or equal to 15 mm horizontal and 20 mm vertical for each observed station.*
- *The rover unit(s) shall not be more than 10 km from the base station.*

Office Procedures: *Proper office procedures must be followed in order to produce valid results. These procedures shall include:*

- *Review the downloaded field file for correctness and completeness.*
- *Check the antenna heights for correctness.*
- *Check the base station coordinates for correctness.*
- *Analyze all reports.*
- *Compare the different observations of the same stations to check for discrepancies.*
- *After all discrepancies are addressed, merge the observations.*
- *Analyze the final coordinates and the residuals for acceptance.*

General Notes:

- *At present, RTK surveys shall not be used for pavement elevation surveys or for staking major structures.*
 - *If the data transfer link is unable to be established, the RTK survey may be performed with the intent of post processing the survey data.*
 - *The data transfer link shall not "step on" any voice transmissions.*
 - *If a UHF/VHF frequency is used for the data transfer link, it shall be checked for voice transmissions before use.*
 - *The data transfer link shall employ a method for ensuring that the signal does not interfere with voice transmissions.*
-

Chapter 10 Terrestrial 3D Laser Scanners

10-1. Purpose

This chapter provides an overview of 3D laser scanners used for detailed mapping of facilities, structures, utilities, and ground planes. High-precision/high-definition tripod mounted laser scanners are covered. Examples of recent applications where these instruments have been used to map Corps facilities or structures are provided.

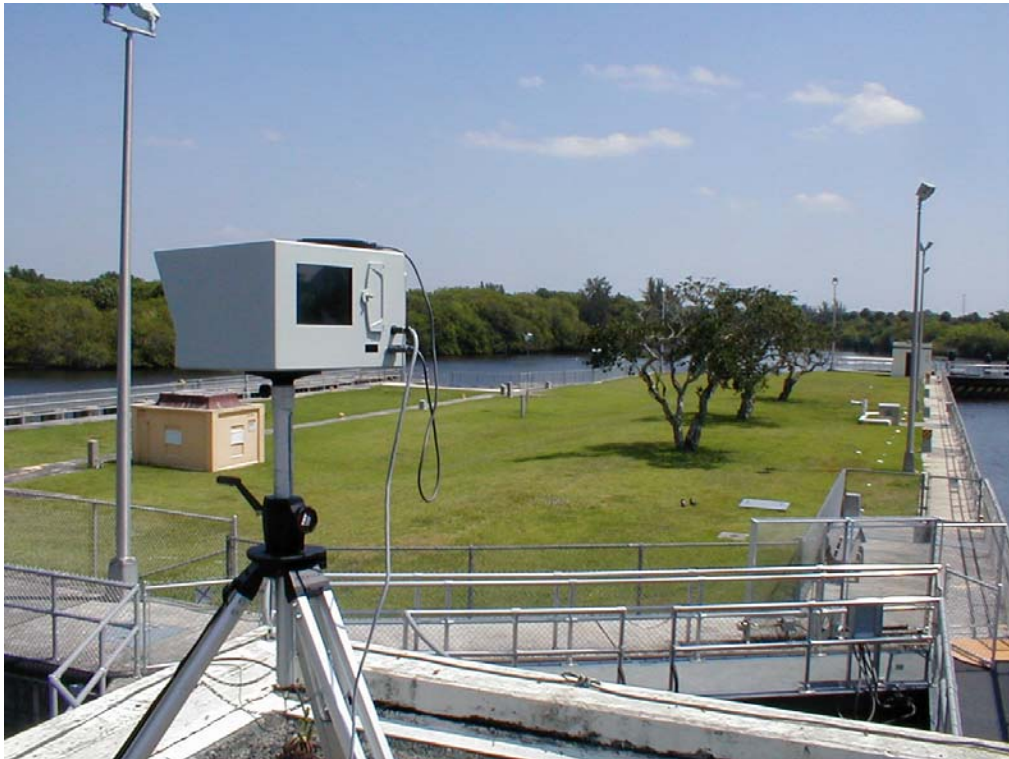

Figure 10-1. Optech ILRIS 3D laser scanner--detailed mapping of structures and facilities at St. Lucie Lock and Dam, Jacksonville District (Arc Surveying & Mapping, Inc.)

10-2. Background

Laser scanners operate similarly to reflectorless total stations. However, instead of a single shot point being observed, a full field-of-view scan is performed--at a speed upwards of 500,000 points per second. Unlike a total station, the location of the scanner is not usually a required input--resulting in points that are spatially referenced to the instrument and not real-world coordinates. This is somewhat analogous to an uncontrolled photogrammetric model. (Newer models allow input of the scanner coordinates from which all observed pixels may be directly georeferenced). The resultant imagery from a scan (termed a “point cloud”) provides a full 3D model of the facility, utility, or terrain that was scanned. Objects can be scanned at a high density--with output pixels smaller than 5 mm. Relative 3D accuracies approaching the millimeter level are claimed, based on redundant observations over a surface. However, 5 to 10 mm accuracy is more realistic in practice. Scans can be rapidly made--a full field-of-view scan of a site or

structure can be performed in 5 to 15 minutes per setup (multiple setups generally are required to fully detail a given site or structure). Unlike a total station, however, laser scanners have no means of assigning feature codes or attributes to the measured points--this must be done in post-processing, and is often a tedious and time-consuming process. Laser scanners have increasing application to many Corps civil and military missions. They can be used to perform traditional topographic surveys (detailed planimetry and elevations) of project sites and facilities--providing ground elevations at a high density. These scanners are especially useful in detailed mapping of exposed (and hard to access) utility systems, such as those inside a hydroelectric power plant. They also have application in mapping archeological sites, HTRW sites, dams, rock faces, hazardous traffic areas, unexploded ordinance sites, or any other inaccessible location.



Figure 10-2. Laser scanned image (upper left) and rendered image (lower right) of Corps Mississippi River Division headquarters building, Vicksburg, MS (ARC Surveying & Mapping, Inc.)

a. Manufacturers. Laser scanners have been on the market for only a few years--since the late 1990s. As of 2005, there were about 12 manufacturers of laser scanners listed in trade publications.

b. Cost. A complete laser scanning system (including a high-end modeling software package and training) can cost between \$150,000 and \$200,000. Thus, few, if any Corps Districts would have a sufficient number of applications to justify this level of expense. In time, it is possible these prices will decrease to a level where 3D scanners may be cost-effective if the workload warrants. Data processing and modeling software is typically expensive; however, it is essential in order to export scanned images to CADD platforms. At present, Corps Districts contract for periodic 3D scanning services--many AE surveying contractors performing Corps work have acquired (or are acquiring) 3D scanners. Given the limited amount of work, the hourly/daily rate is understandably high for these scanners (and data processing)--daily operating costs of \$2,000 to \$5,000 or more (including processing) are not uncommon, and can vary widely depending on the amount of processing required. Most often, a project cost would be negotiated on a lump sum basis, factoring in the basic daily rental cost of the scanner plus the operator and CADD processor time estimates.

c. *Accuracy.* The accuracy of a scanned object can be relative or absolute. Relative accuracies are very good (5 mm or better at close ranges). Absolute accuracies depend on the accuracy of the control network developed for the site, how accurately the instrument is aligned to this network, and how well overlapping images (i.e., picture points or targets) are transferred and adjusted (best fit). In general, absolute accuracies can be kept within 1 or 2 centimeters over a small project/structure site. In many cases, relative accuracies are far more important than absolute geospatial accuracies. For example, measurement of a crack in a wall requires a high relative accuracy; however, the absolute geospatial coordinates of the crack are not significant. Overall accuracy is a function of range, scan density, spot/footprint size, and single point accuracy (Jacobs 2004).

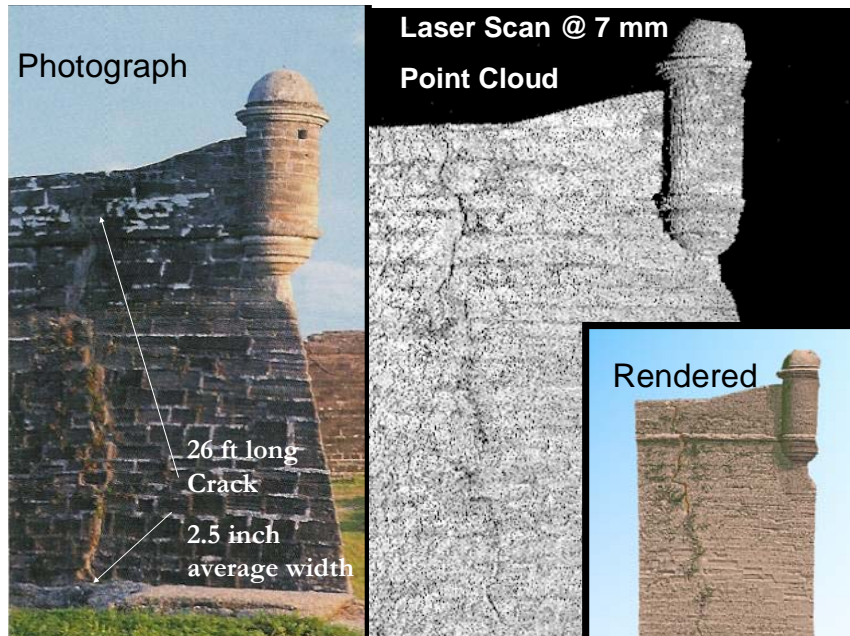

Figure 10-3. Crack measurements with a 3D laser scanner. Castillo de San Marcos, Saint Augustine, FL (Arc Surveying & Mapping, Inc. for National Park Service)

d. *Density of scanned points.* Laser scanners can be set to any desired scan density, e.g., 5 mm to 1 meter, usually based on some short nominal distance. The higher the density the larger the resulting dataset--and more time-consuming data editing and processing. The purpose of the project determines the required density. For general 3D planimetry or buildings or ground elevations, a low density can be set. For detailed maps of structural members or concrete cracks, a high density is set.

e. *Field-of-View.* Depending on the model and project requirements, scanners can be set to scan a full 360 deg field or zoomed (windowed) into a narrowly set field-of-view. The Leica HDS4500 scanner has a field-of-view of 360 deg horizontal by 310 deg vertical. The reality of scanning means that even a 360° field of view does not guarantee full area coverage; in fact, it rarely does. Laser shadowing forces data to be collected from multiple angles for complete data coverage. A large field of view does not alleviate this requirement. Also, the angle of incidence of a measurement will have a profound impact on its accuracy and the resolution of the data in general. Keeping this fact in mind, imagine surveying a long, flat wall. If the scanner has a 180° horizontal field of view it will be able to survey the wall in a single scan. Depending on the length of the wall, measurements may be collected from angles that approach 90°, but the reliability of these measurements will be very poor.

f. Range. Range of scans is a function of the laser intensity and reflectivity of the object scanned. Some scanners are designed for only close up scans--i.e. 200 meters. Others claim ranges of upwards of 1,000 meters--or more. Obviously, the longer the range, the larger the footprint and less accurate the resultant measurement becomes. In general, most detailed scans of facilities, buildings, and structures are kept at close range--usually less than 500 ft and not much beyond 1,000 ft. The laser eye safety classification may also be a factor in longer-range scanners--a Class 3 type laser may not be desirable for surveying a populated beach but would be acceptable at a remote HTRW site. (A Class 1 laser device "denotes exempt lasers or laser systems that cannot produce a hazard under normal operating conditions" and a Class 3a laser device "denotes visible lasers or laser systems that normally would not produce a hazard if viewed for only momentary periods with the unaided eye. They may present a hazard if viewed using collecting optics."). The ranging capability of a laser scanner is more important than it first seems. In some cases, the lack of ranging ability will completely eliminate the ability to do certain projects. For example, let's examine the case of a bridge that crosses a body of water. A lack of certain characteristics (such as a 360° field of view) may force you to collect more scans but it doesn't prevent the project from being completed. The inability to range to the structure, with no provisional means of getting closer, will eliminate the potential of the scanner being used on the project. It is also true that a survey will rarely be conducted at a range greater than a few hundred meters (except in cases similar to the above example). However, long-ranging capability has other benefits that are not immediately identifiable. At the extreme limit of a scanner's specified range, the accuracy of the measurements will begin to decrease in a non-linear fashion. As such, let's consider the example of scanning a structure from 150 m away. The scanner whose maximum range is 150-200 m will struggle to collect the data. It may succeed, but the measurement quality will suffer and the dataset will contain a large number of "drop out" points (instances where no measurement was collected). Alternatively, the scanner that provides 1,000 m range will be collecting data from the ideal area of its total dynamic range. The data collected will be of optimum accuracy.

g. Beam footprint size. The footprint size will vary (increase) with the distance from the scanner to the object. Typically, on close-range applications (less than 100 ft ranges), a 5 mm footprint is observed.

10-3. Scanner Operation and Data Processing

Scanners are normally mounted on a tripod, directly onto the plate or in a standard tribrach. The scanner is set up at any arbitrary location that affords the best view of the area or object to be mapped. No absolute geospatial orientation of the scanner is required (unless the scanner model is designed to incorporate geospatial references). Most structures require multiple scans in order to develop a complete 3D model, as illustrated in Figure 10-4 below. In addition, multiple scans are required to cover hidden, shadowed, or obstructed areas in a single scan. Thus, a rectangular building will require scans from four setups offset from each of the corners--each scan providing data covering two faces of the building, which will overlap with adjacent scan locations. These overlapping scans allow a full 3D model of the building to be generated using imagery correlation (optical recognition) software (similar to soft-copy photogrammetry). The scanned "point clouds" are saved on flash memory devices in the scanner, which can be later downloaded to a field or office computer. The overlapping "point clouds" from each scan are edited for data spikes--often a lengthy process. They are then merged to form the full 3D model. This merging is done in proprietary software that is usually sold separately with the laser scanner. This resultant 3D model is referenced only to a relative/internal coordinate system. If real-world geographic X-Y-Z coordinates are required (and they are not always needed for many project applications), then targeted points need to be set in the scanned area/structure in order to perform a standard coordinate transformation. Once the model is generated, a variety of computer graphic enhancements can be performed. These include coloring, wire meshing, rendering, and smoothing objects. Rough point cloud images of solid objects can be smoothed using various software-fitting routines--e.g., items such as wall

faces, cylindrical pipes, etc. If the resultant model is going to be exported to a CADD or GIS platform, then additional descriptor, attribute, or layer/level assignments may be required. Final data processing can represent a significant effort on some projects--a structure that is scanned in 4 hours may take as much as 40 hours or longer to process the data to a CADD compatible format. The software used for processing scanned datasets is a critical component in the overall efficiency and economy of the process.

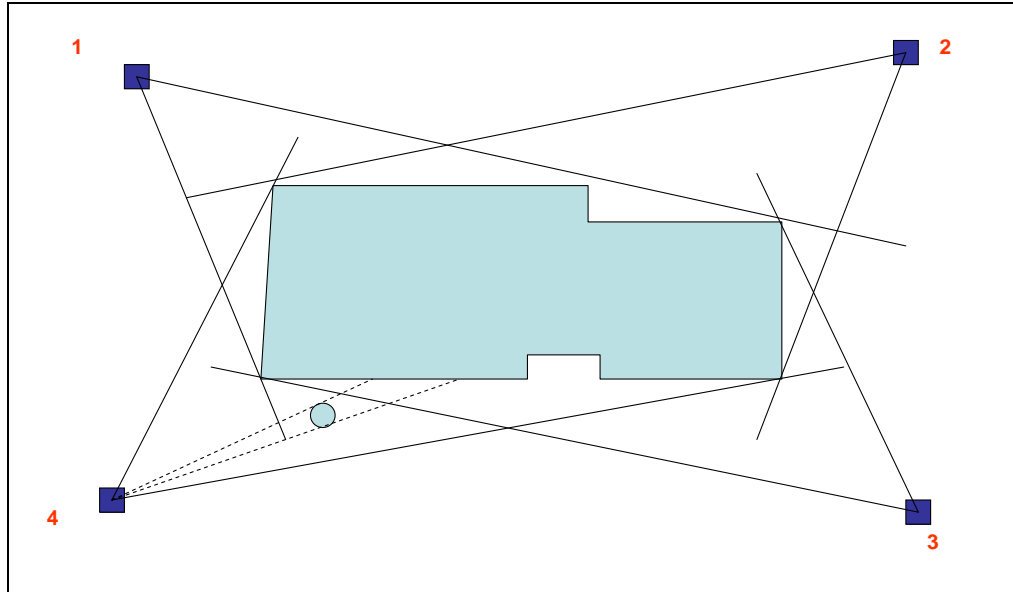

Figure 10-4. Typical four scan locations needed to fully model a building and cover obscured areas. In practice, additional scan points may be needed.

10-4. Corps of Engineers Project Application: St. Lucie Lock and Dam, Jacksonville District

The following figures illustrate an application of 3D laser scanning on a Corps civil works project--mapping lock and dam structures and related grounds and facilities. This project (in 2001) involved both topographic and hydrographic surveying of the lock and dam site. An Optech laser scanner was used to capture images around the project. Given the complexity of the site, numerous instrument setups were required to fully cover the site. The individual point clouds were merged and a continuous 3D model of the lock and dam was created. Additional color rendering was also performed. The above ground Optech laser data set was subsequently merged with 3D hydrographic data obtained with a multibeam echo sounder. (This project was performed by Arc Surveying & Mapping, Inc. for the Jacksonville District).



Figure 10-5. Typical scan location to cover downstream gate structures--instrument set up between 6th and 7th gates

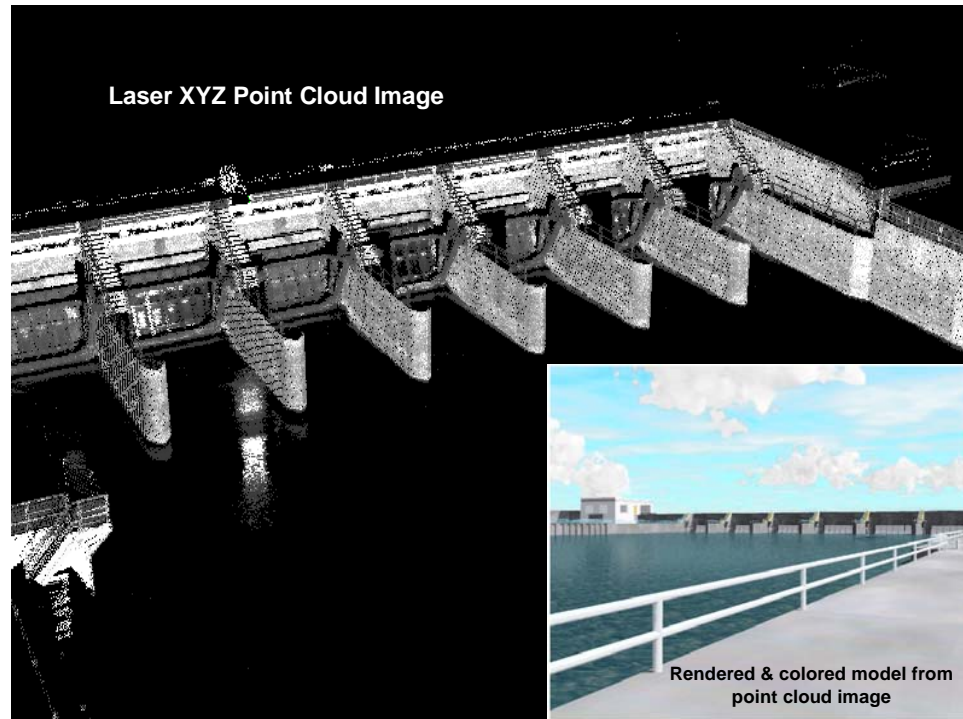

Figure 10-6. Merged point cloud images of gate structures, from multiple scanning locations

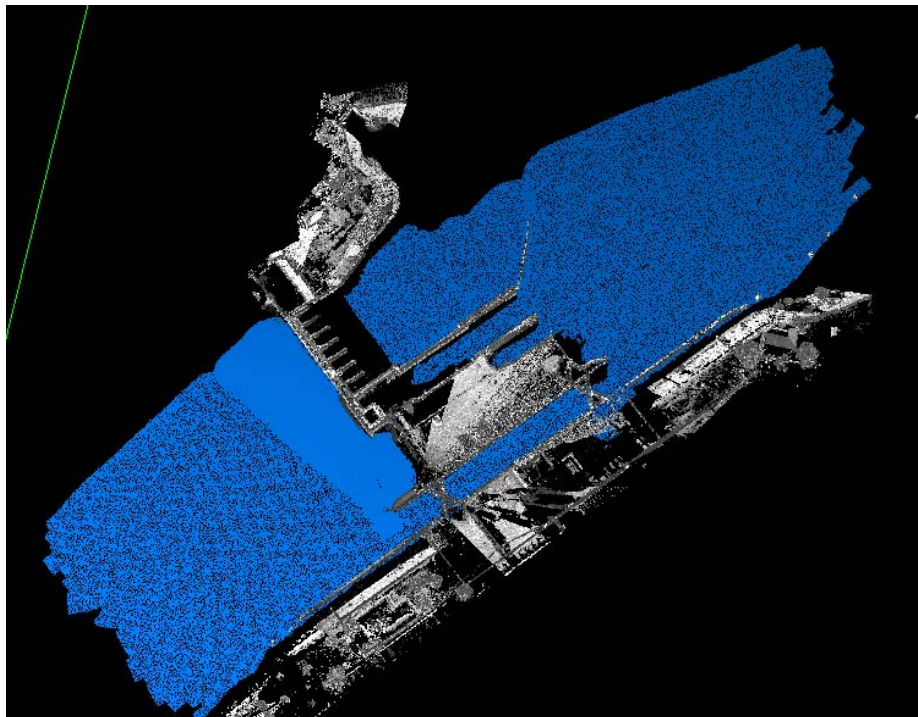

Figure 10-7. Merged Optech laser scanned imagery with subsurface multibeam imagery--resultant 3D imagery model of entire lock and dam project

10-5. Corps of Engineers Project Application: Portuguese Dam Foundation Construction, Ponce, PR, Jacksonville District

The following figures depict a topographic survey of the foundation for the Portuguese Dam north of Ponce, Puerto Rico. These scans were made during grouting operations at the foundation. The entire area surrounding the foundation was scanned, and georeferenced to the local coordinate system using targeted reference points in the scans. A conventional total station survey on a 10 ft x 10 ft grid was performed over the same area and compared with the far denser matrix generated from the laser scan. Rappelling techniques had to be employed to reach many of the total station shot points in this rugged mountainous terrain--these same points were easily and safely tied in with a Cyrax 3D laser scanning system (Cyra Technologies--now Leica). These surveys were performed in 2000 by Arc Surveying & Mapping for the Jacksonville District.

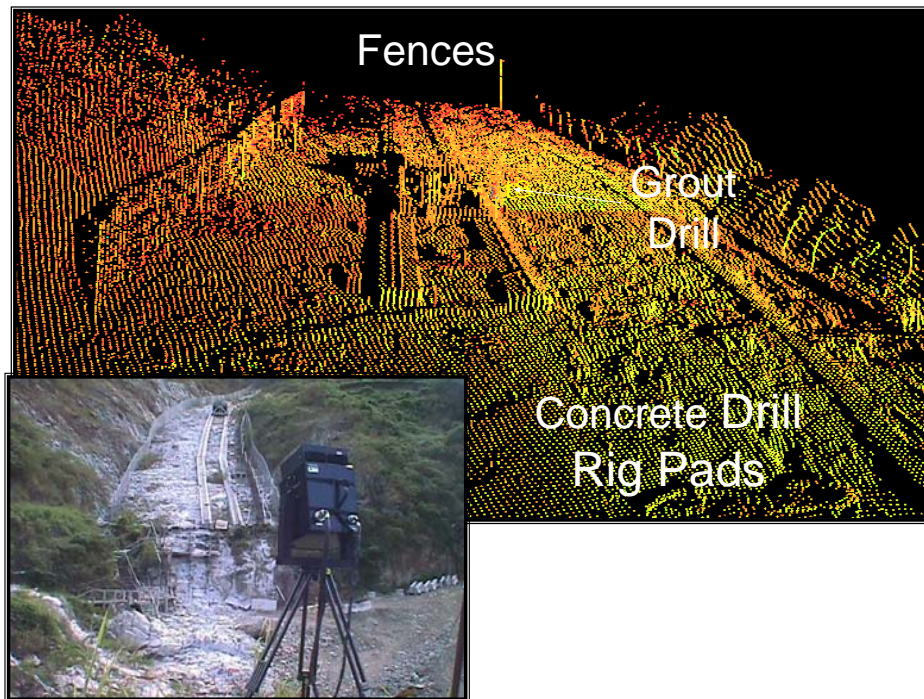

Figure 10-8. Portion of Portuguese Dam foundation scanned by Cyrax laser (Arc Surveying & Mapping, Inc.)

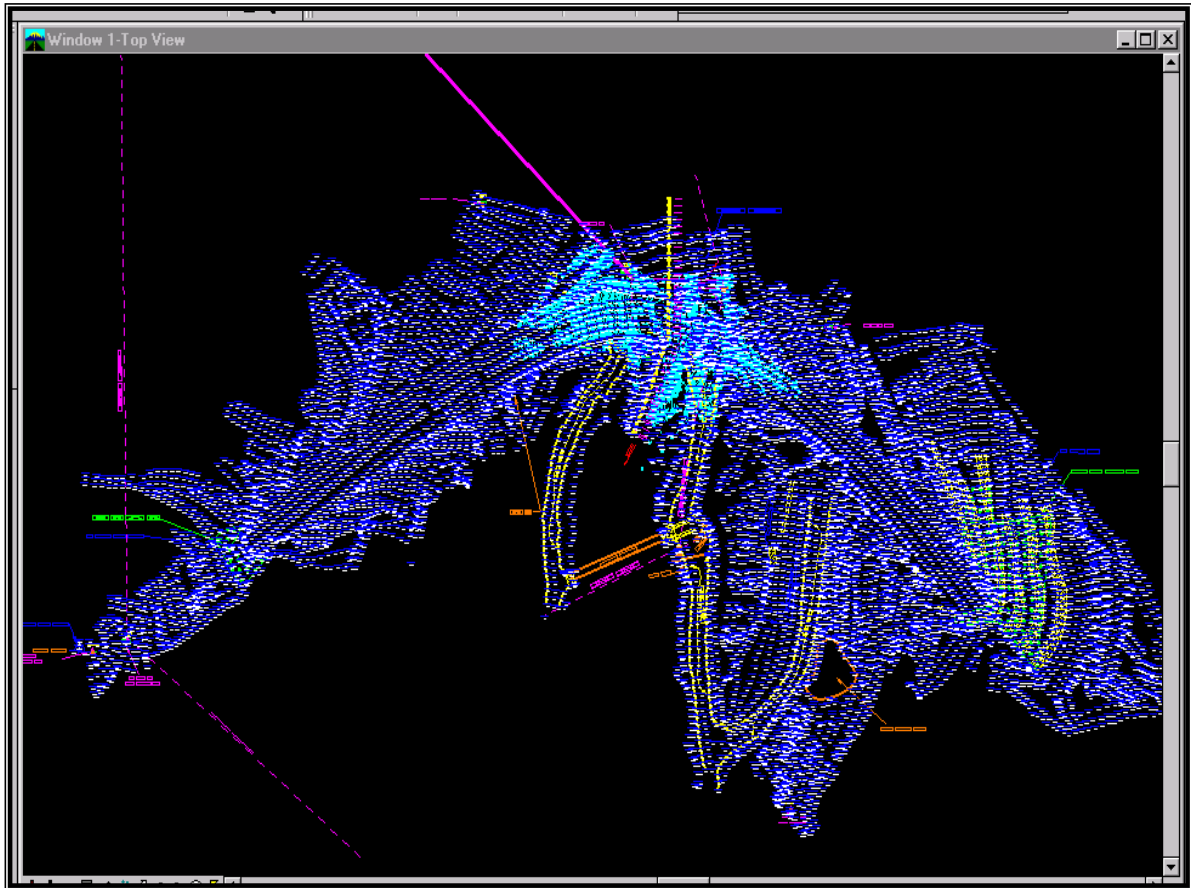

Figure 10-9. Merged datasets: Conventional total station topography and 3D laser scanned model (Portuguese Dam foundation--Jacksonville District)

10-6. Corps of Engineers Application: Steel Bayou Levee Surveys, Vicksburg District

The following figures depict a topographic survey of a levee using a 3D laser scanner. This was a demonstration project performed for the Vicksburg District; to assess the capabilities of terrestrial laser scanners for levee surveys. Comparisons were made between the scanned surveys and conventional topographic surveys performed by the Vicksburg District. A major problem with scanning flat terrain is the limited range when the scanner is set on a standard tripod. To be effective, an elevated platform is needed to obtain a more effective working range. Establishing georeferencing on the scanned images is also problematic in a linear scan over a flat area. Targeted control along the top of the levee is needed to reference each scan and may not be a cost-effective process. In addition, this demonstration project was conducted with 2-ft height grass on the levee. Since the laser picks up the top of grass, any practical use of 3D laser scanners must be performed immediately after vegetation is cleared--or in sites without vegetation. Effective use of laser scanners on flat terrain is marginal unless an elevated view site can be obtained.

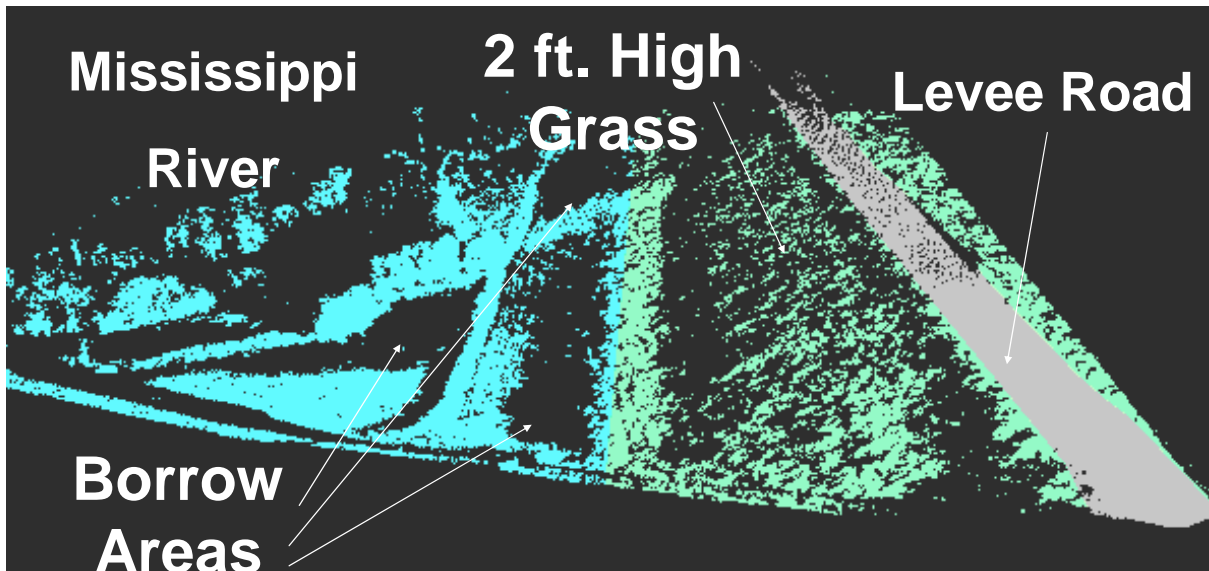

Figure 10-10. Scanned images of Steel Bayou levee in Vicksburg District. Scanner elevated to maximum height in order to extend distance.

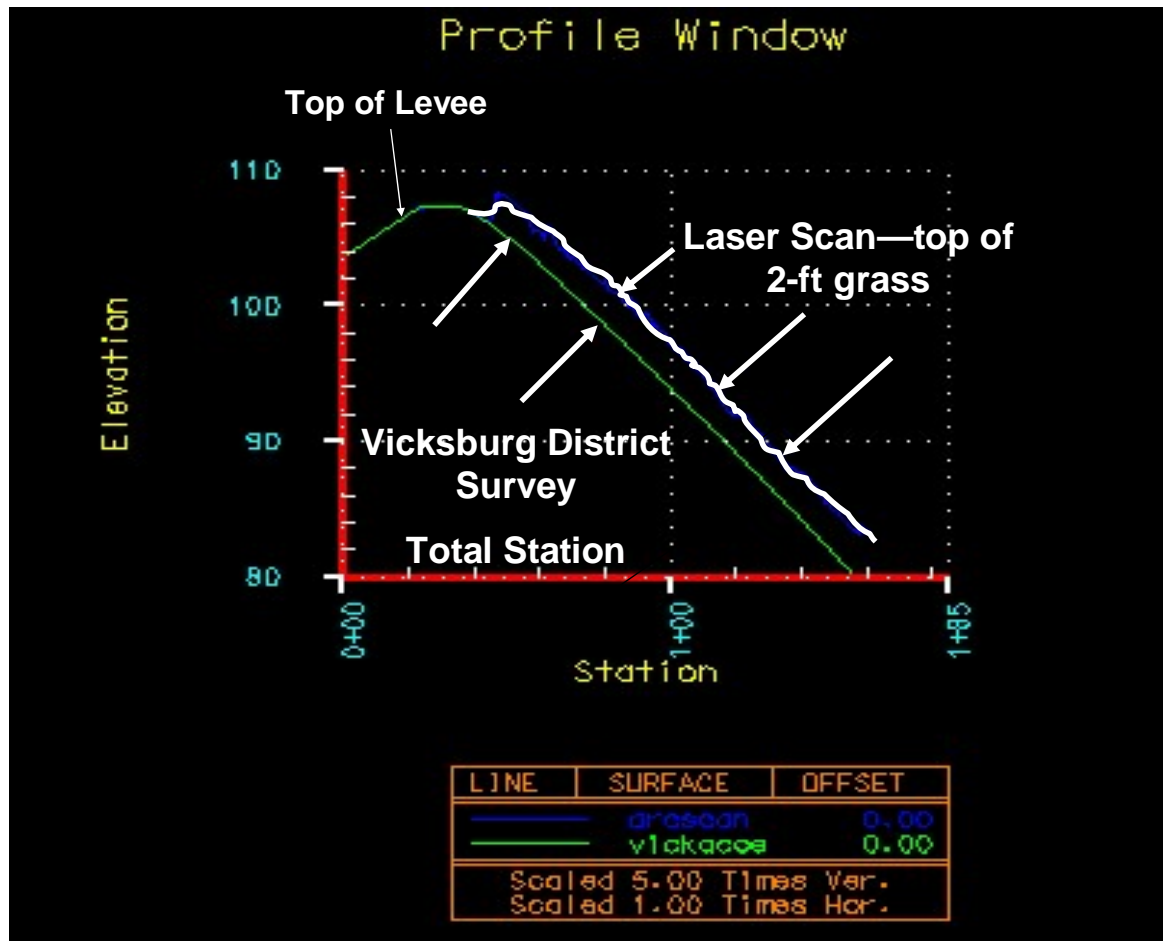

Figure 10-11. Levee cross-section: comparison between conventional total station survey and 3D laser scanner

10-7. Corps of Engineers Application: Structure Subsidence Survey, Philadelphia District

The following figures illustrate another application of 3D laser scanning on a Corps civil works project-- monitoring subsidence for lock and dam structures. This was a demonstration project performed by TVGA Consultants for the Philadelphia District, to assess the capabilities of terrestrial scanners for subsidence monitoring. The location of dam outfall structure for the Francis E. Walter Dam makes access extremely difficult, time consuming and requires a detailed safety plan be prepared and followed. Given the complexity of the site conditions and instrument setup distance from the structure an Optech Ilris laser scanner was used. GPS observations on the local control monumentation was collected and tied in to independent offsite control. Using conventional reflectorless total stations, targeted control points were geo-referenced to the project control network. The individual point clouds were merged and a continuous 3D model of the outfall structure was created. Additional color rendering was also performed.



Figure 10-12. Francis E. Walter Dam located in Whitehaven, Pennsylvania. Concrete outfall structure located on the downstream side of the dam is shown at bottom right.



Figure 10-13. Optech Iris Unit positioned in center of river bed at the Francis E. Walter Dam site located in Whitehaven, Pennsylvania.



Figure 10-14. Reflectorless Total Station was utilized to georeference scanner data to project control network

Chapter 11 Final Site Plan or Map Production

11-1. Purpose

This chapter provides general guidance on preparing final site plan maps from topographic survey data acquired in digital format in the field. Different methods of transferring data into CADD and GIS platforms are described.

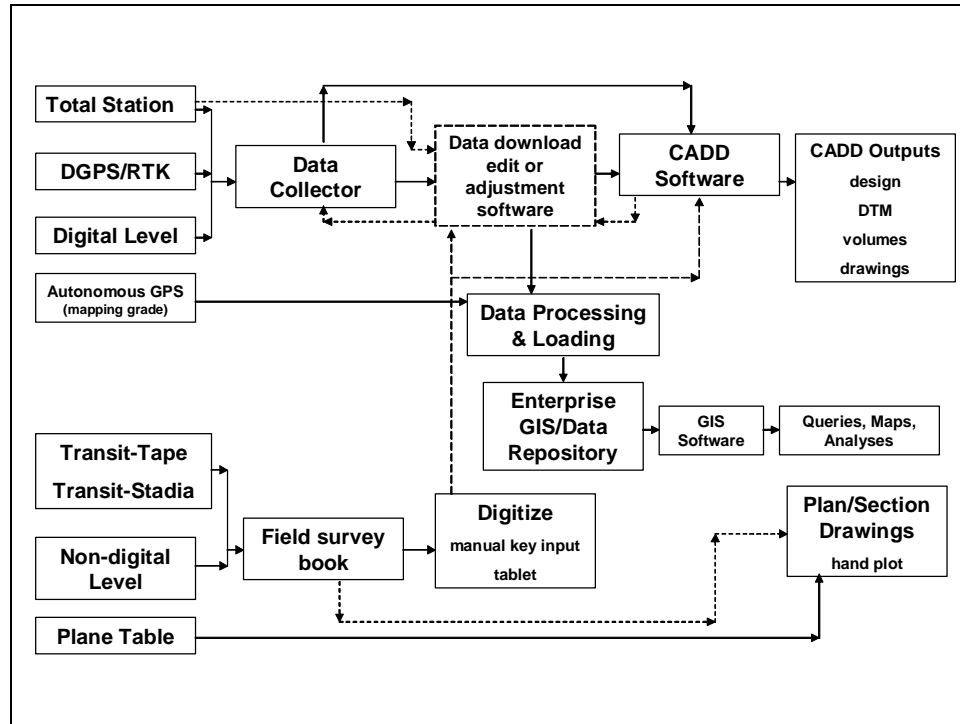

Figure 11-1. Overview of survey data flow

11-2. Overview of Topographic Survey Data Flow

Figure 11-1 above outlines the various routes by which topographic data are processed into a final site plan map format. As indicated in the figure, a number of processing options exist, depending on the software.

a. Field instrument and data collector. The field survey instrument may have an internal or external data collector. Total stations can export internal data directly to a processing software package, without going through an external data collector. GPS/RTK units typically record to an external data collector. Manual data collection is recorded in a field book which must be reduced by hand. If a digital file is desired, field book data must be manually keyed into a software program. A plane table survey obviously is field-finish system in which a final drawing containing planimetric features and contours is generated directly in the field.

b. Data download, editing, and adjustment software. Intermediate data download, edit, and adjustment software may be required for some data collectors. GPS data may require processing at this

stage, using software such as Trimble TGO. Total station data is usually downloaded to an office PC using software compatible with that used on the data collector. TDS SurveyPro is an example of this type of software. Depending on the input format of data from the collector (*.raw, *.cr5, etc.), the software may have to create an X-Y-Z coordinate file from the raw data observations. Feature and attribute editing may also be performed at this stage. In addition, feature libraries can be backloaded to the data collector; including processed design files from the CADD software.

c. CADD and GIS software. Numerous software packages are used to process survey data into a final design or map product. All have various options and capabilities. Bentley and AutoDesk are the most common CADD packages used in the Corps. Each CADD vendor has a variety of optional packages which input survey data for use in a final design application. Examples include AutoDesk Land Desktop, AutoDesk Field Survey, Bentley GEOPAC, AutoDesk CAiCE, TDS ForeSight, Trimble Terramodel, Carlsen SurvCadd XML, AutoDesk Land Development, ESRI Survey Analyst, and Bentley InRoads. Some of these packages simply utilize fully processed and edited data to generate final products. Others have survey editing, adjustment, and COGO options built in, along with final drawing capabilities. Each package is generally tailored to a specific engineering discipline--e.g., CAiCE is used for highway design and construction. Many CADD packages will import field data directly from the data collector. Others are restricted to importing data only in certain formats or from specific data collector models. CADD software display capabilities include 2D and 3D models, sheet layout, contours (Figures 11-2 and 11-3), etc.

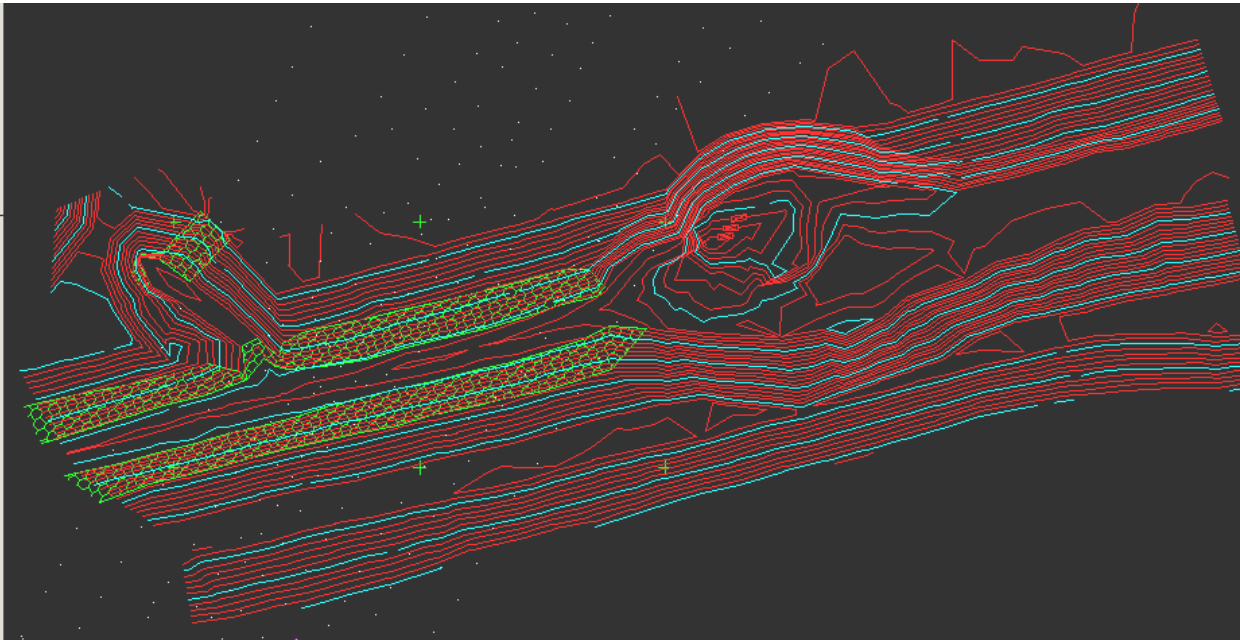

Figure 11-2. MicroStation contour generation from topographic survey of scour erosion site along Sanders Creek, Pat Mayes Lake, Texas (Tulsa District)

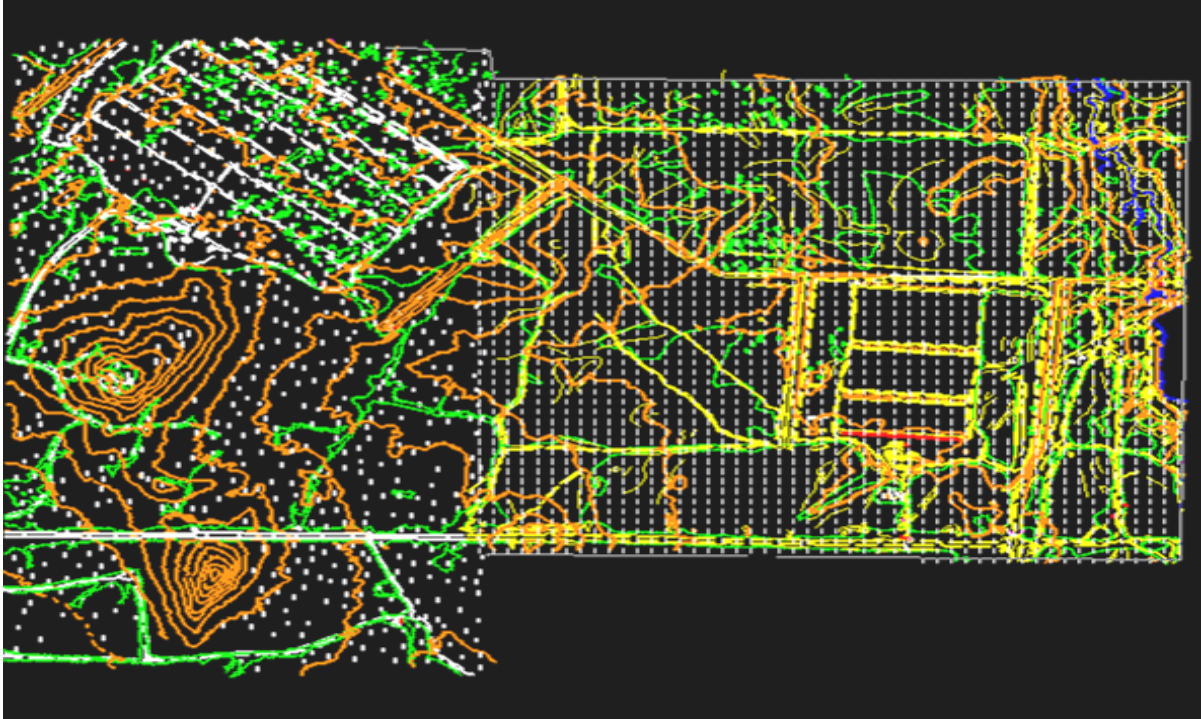

Figure 11-3. MicroStation file Showing Planimetric and Topographic Mapping of 440 acre Range at Fort McCoy (Louisville District)

11-3. Basic Definitions of Geospatial Data used in CADD or GIS Databases

The following subparagraphs detail some of the basic concepts and features required for field-collected topographic data that is exported to a CADD or GIS platform. These include descriptions of data dictionaries, types of feature codes and attributes, methods of feature code collection, and processing features with attributes.

a. Data Dictionary. A Data Dictionary contains the following information:

- Feature and Attribute Library
- Intelligent Features Codes
- Data about Feature Codes

A data dictionary is created using software designed for that purpose. Features and attributes are selected, along with attribute values and expected ranges. The edited data dictionary is uploaded to the data collector. Feature symbols can also be selected for display on the field data collector. The data dictionary software should also have an ability to import a file containing existing GIS table structures or CADD layers and symbols. An example of a Trimble TGO Data Dictionary editor was provided in Chapter 7.

b. Feature Codes. Feature Codes are descriptors identifying some unique property associated with a topographic feature.

c. Cartographic data. Cartographic data are observations (or shots) on spatially distributed features, activities, or events, which are definable as:

- Points
- Lines (Arcs)
- Areas (Polygons)

d. Attributes. Attributes are descriptive information in a database about the cartographic features located on a map. Attributes describe the characteristics of a feature--they are often referred to as non-cartographic data. Attributes can be any numeric or character value that describes the feature. Examples of attributes assigned to a tree might include:

- Height
- Diameter
- Species
- Condition
- Age

e. Attribute Values. Attribute values are sub details given to an attribute. For example, possible values for the attributes of the above Tree feature might include:

- Height = 15m
- Diameter = 0.75m
- Species = Oak
- Condition = Good
- Age = 8 years

When attribute data is collected in the field, the user may be prompted on the data collector when a particular feature is shot. Attribute values can be classified as character, numeric, date, or temporal fields. This prevents the input of an incorrect value into an attribute field; for example, preventing the entry of characters into a numeric field. Attribute range limitations (or domains) are also held in the dictionary to prevent gross blunders in entering attribute data--e.g., a 0.1 ft or 1,500 ft height tree.

f. Point Features. A point feature represents a single geographical location (such as a latitude/longitude and altitude)--see Figure 11-4 below. A point feature type is used to represent a feature that has no length or width. Examples of point features are:

- Tree
- Lamp Post
- Power Pole
- Fire Hydrant
- Manhole

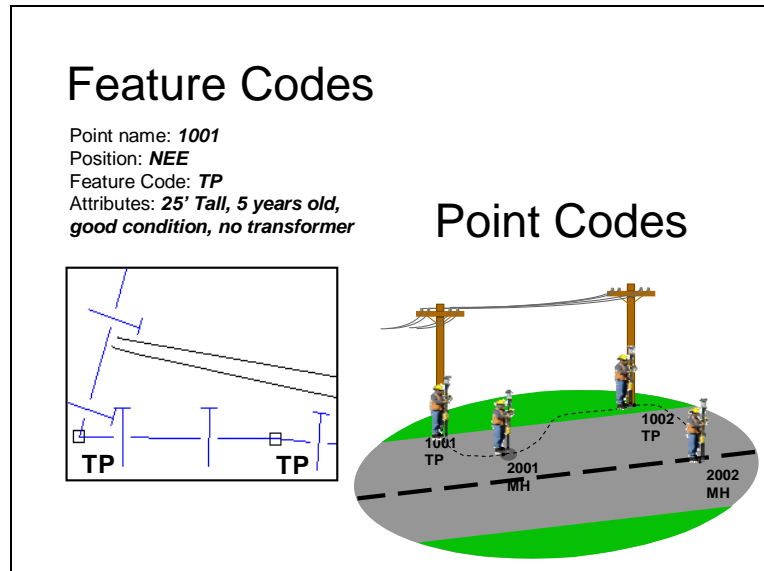

Figure 11-4. Point Codes and Feature Codes (David Evans & Associates)

g. *Line Features (breaklines, arcs, strings, or polylines).* A GIS line feature type is a series of geographical locations that are connected--so-called "arc-nodes." A line feature type is also used to represent a feature which has a length but no width. Some GIS's refer to line features as arcs. CADD software will mathematically define line strings as opposed to connected points in GIS. Breaklines are connected strings, as shown in Figure 11-5 below. Examples of line features are:

- Roads/Railways
- Streams
- Animal trails
- Routes

Line features will have various attributes similar to point features, e.g., storm sewer pipe diameter, type, thickness, date set, etc.

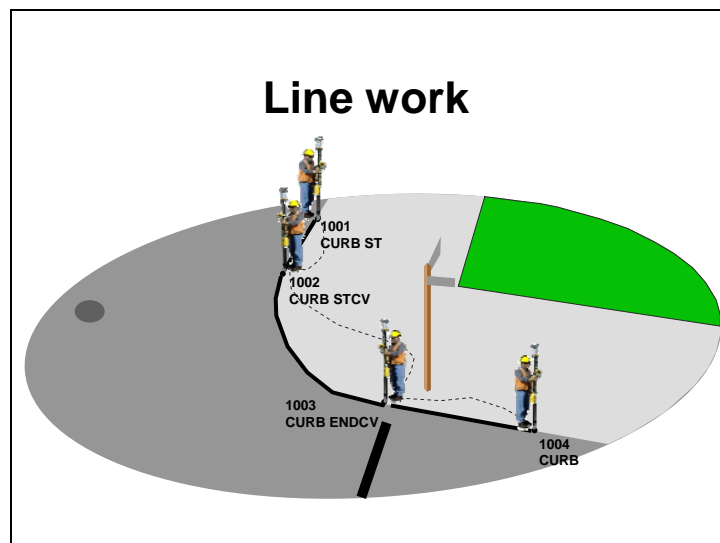
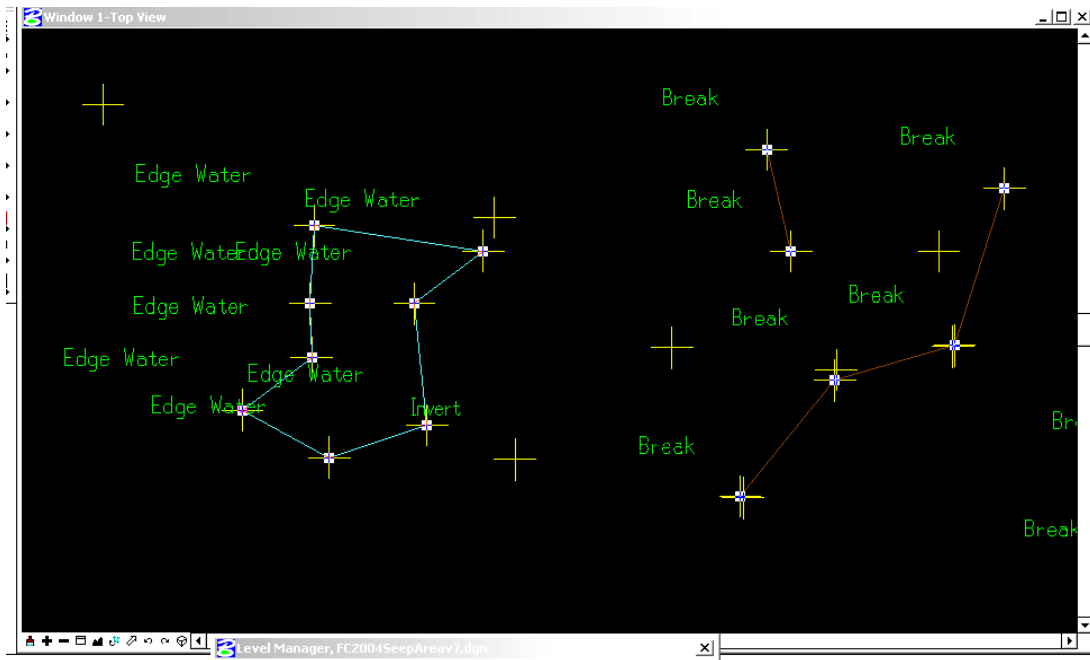

Figure 11-5. Delineating line features (David Evans & Associates)



**Figure 11-6. Breaklines and connected line features
(Portland District 2004 Survey of Fall Creek Seepage Area)**

h. Area Features. Areas (polygons) are a series of geographic coordinates joined together to form a boundary. An area feature type is a closed line. An area feature has a length and a width and can have attribute data. In GIS, area features are referred to as polygons. A polygon is a single arc or a series of arcs that are connected together in order to enclose an area. Examples of area features are:

- Soil types
- Wetlands
- Flooded land
- Lakes
- Parking Lot
- Building
- Soil types

i. ESRI Shapefiles. A GIS shapefile stores nontopological geometry and attribute information for the spatial features in a data set. The geometry for a feature is stored as a shape comprising a set of vector coordinates. Because shapefiles do not have the processing overhead of a topological data structure, they have advantages over other data sources such as faster drawing speed and edit ability. Shapefiles handle single features that overlap or that are noncontiguous. They also typically require less disk space and are easier to read and write. Shapefiles can support point, line, and area features. Area features are represented as closed loop, double-digitized polygons. Attributes are held in a dBASE® format file. Each attribute record has a one-to-one relationship with the associated shape record. Shapefiles are created using various ESRI products (e.g., ArcGIS).

11-4. SDSFIE Data Model

The SDSFIE data model described back in Chapter 2 contains the following element definitions taken from Release 2.300. (See also ERDC/ITL 2002b "*SDSFIE/FMSFIE Data Model and Structure*").

- ◆ Entity Sets - Broad grouping for data management
 - ◆ *Entity Sets* are the highest level of the SDSFIE data model structure and represent data organized at the project level.
 - ◆ *Entity Sets* are broad, generalized themes containing groupings (called Entity Classes) of features (i.e., graphic objects (called Entity Types) which can be depicted at their actual geographic locations on a map) and related "graphic" attribute data (i.e., data (information) about the feature which is stored in a database table).
 - ◆ The SDSFIE Release 2.40 structure contains the following twenty-six Entity Sets: (1) Auditory, (2) Boundary, (3) Buildings, (4) Cadastre, (5) Climate, (6) Common, (7) Communications, (8) Cultural, (9) Demographics, (10) Environmental Hazards, (11) Ecology, (12) Fauna, (13) Flora, (14) Future Projects, (15) Geodesy, (16) Geology, (17) Hydrography, (18) Improvements, (19) Landform, (20) Land Status, (21) Military Operations, (22) Olfactory, (23) Soil, (24) Transportation, (25) Utilities, (26) and Visual.
- ◆ Entity Classes - Grouping of data within each Entity Set
 - ◆ Corresponds to a map file, so it contains CADD layers or levels.
 - ◆ The SDSFIE is designed to be CADD/GIS platform independent, which means the standards are designed to work with the *most limiting* of the predominant commercially available CADD/GIS platforms which will be used.
- ◆ Entity Types - Grouping of Items that appear graphically on a map or drawing.
 - ◆ The logical name of a type or object that can be graphically depicted on a map or drawing.
 - ◆ Grouping or collection of like Items (entities) that appear graphically on a map or drawing.
 - ◆ Has a corresponding attribute table (database table containing information concerning the entity type).
- ◆ Attribute Tables - A relational database table containing non-graphic information, or attribute data.
 - ◆ A relational database table containing attribute data.
 - ◆ "Graphic" attribute table - linked to a graphic entity, and contains data describing the graphic entity, along with other data and relationships required for geospatial and relational analysis.
 - ◆ "Nongraphic" attribute table - contains data and relationships which may be queried for geospatial and relational analysis.
- ◆ Domain Tables - Contains lists of "valid" or "permissible" values for specific attributes in an Attribute Table.
 - ◆ A relational database table containing lists of permissible values for specific attributes.
 - ◆ Provides a finite set of "valid" or "allowable" values, and may be enlarged as necessary.
 - ◆ Includes units of measure, materials, methods, dispositions, classes, status, phase, etc.
 - ◆ May be either "LIST" or "RANGE"

For additional information on the SDSFIE Model see: <https://tsc.wes.army.mil/products/tssds-tsfs/tssds/html/sdsdocin.asp>

11-5. Data Collection and Processing Procedures for Topographic Surveys

There is no standard process for moving digital field observations into a CADD platform. The steps taken vary with the type of total station used, including its internal or external data collector. Field data collection procedures can vary from simple single shot points to fully attributed polyline strings. A variety of data formats can be output from the different data collectors on the market. The field data may be imported directly into a CADD package or processed through intermediate survey software before being uploaded into the CADD package, as was illustrated in Figure 11-1 at the beginning of this chapter. Over 50 different survey software and CADD systems are listed in the most recent compilation by POB Magazine (POB 2004c). Given this variety of CADD/survey software, there are numerous methods used to process data from the field to finished CADD or GIS product. Corps districts primarily use either MicroStation or AutoCAD, with MicroStation being more predominant. However, most data collector software is geared more towards export to AutoCAD than MicroStation. The following steps highlight a general process used in most systems. However, the trend today on some total station systems is to develop data on the data collector that imports directly into the CADD platform without all the intervening steps and varied format conversions described below.

Step 1--Observations. In the first step of the process, the field survey vertical and horizontal angles are measured along with slope distances using the total station. The angles and distances are stored with a point number and description in the data collector. Optionally, attribute data may also be stored with each point, including line/area string codes. COGO routines in the data collector may be employed to convert raw observed data to local grid X-Y-Z coordinates; optionally, these conversions may be made on a PC after the data are downloaded. If a RTK system is used, radial X-Y-Z coordinate data for each observed point is attached with a descriptor identifier code and saved in the data collector.

Step 2--Transfer data from data collector to PC. After completing the survey, the data are then transferred to a field or office computer via telephone, cable, or infrared modem for data processing and editing. The computer is either an in-office desktop system or a laptop model that can be used on site. A number of software systems contain modules for performing this data transfer process. Data transfer programs were described back in Chapter 7. One or more files may be downloaded from the data collector. Depending on the data collector software, these downloaded datasets might include:

- Raw data files in ASCII format containing all original survey, project, and attribute observations keyed or processed in the data collector.
- Native binary format of the above file
- Coordinate file containing reduced X-Y-Z-attribute data for each observed point
- Other types of field recorded data may also be downloaded, e.g., pen tablet field sketches and notes, digital photo images, etc.

Step 3--Reformatting. If a coordinate file was not directly generated in the field, then the raw data files must be processed in the computer to produce a coordinate file that contains point number, point code, X-Y-Z coordinate values, and a point descriptor. Survey software packages provide review and edit capabilities at this stage of the processing, checking point codes and descriptors before they are imported into the CADD platform. These software packages are also useful in generating standardized feature and attribute codes which can be uploaded to the data collector to ensure consistent observing methods.

Step 4--Convert data into a graphics design file for use in a CADD program such as MicroStation or AutoCAD. A number of software conversion programs are available to convert raw data collector files

into a CADD file. The program CVTPC, available from ERDC, is an example of a program commonly used to convert the ASCII files into 2D or 3D MicroStation design files. Level, label, symbol, and line definitions are assigned to each point based upon a point code. CVTPC can be obtained by linking to ERDC from the USACE home page at <http://www.usace.army.mil>.

Step 5--CADD specific applications. Once data are contained in the CADD platform, the basic topographic data can be plotted for review and edit. Digital terrain models (DTM) can be generated that can be used to generate contours, quantity take-offs, etc. Final editing and addition of notes are completed, yielding topographic data in a digital format or as a plotted map. Sheet layouts are assigned and the topographic data are ready to be used for their intended engineering, design, planning, or construction function.

As stated previously, many of the above steps can be skipped if field data are collected using procedures, software, and coding that is directly compatible with the final CADD platform. Thus, uniform operating procedures are needed when collecting and processing survey data. The use of proper field procedures is also essential to prevent errors or omissions in generating the final site plan or map products. Collection of survey points in a systematic and meaningful pattern aids in this process. If consistent field procedures are employed, then a minimal amount of post-processing or editing on the CADD platform will be required.

a. Various software/ hardware packages are available to collect and process survey data. Some data collectors are actually PC-based processors that can log total station data and run various survey adjustment software packages. Field PC-based software can perform post-processing and adjustments, and import the data directly into a CADD workstation.

b. When procuring components of a data collection and processing system, compatibility between components and a minimum capability must be assured. Survey coordinates with a descriptor or code to indicate the surveyed feature should be input, as a minimum, to the CADD system. ASCII X-Y-Z or latitude-longitude-height data, along with alphanumeric descriptor data, are usually accepted by CADD software and are commonly output by data collectors or survey processing programs. The CADD program should have some flexibility in the order the coordinates are received (X-Y-Z, Z-X-Y, etc.) and the length of the data records.

c. More complex and sophisticated information, such as contour lines and symbols, can sometimes be passed from survey to CADD programs through common graphic formats, such as DXF. However, note that a 100% reliable transfer of graphic data is not always possible. For example, contour lines passed to a CADD program in DXF format may have isolated breaks or overlap. Transfer of graphic data using proprietary formats is usually most reliable.

d. Transferring data to a field or office PC is a fairly straightforward process and is usually detailed in the operating manuals associated with the data collector software or CADD/GIS software. Field data are often transferred directly into a CADD or GIS software program using import features on that program. Optionally, an ASCII file may be created on the PC that is generic to any CADD/GIS program. These CADD programs can usually import data from a variety of survey systems and data collectors, including generic datafiles.

11-6. Field Computers and Software for Viewing and Processing Data

Many districts perform much of the survey reduction, processing, editing, and adjustment in the field, and are transferring files directly into a CADD package. The greatest advantage of this procedure is uncovering a mistake which can be easily corrected if the crew and equipment are on the site. Laptop and

notebook computers are normally used to download GPS and total station data. Once the files are stored in the computer, data processing and plotting in a CADD package can be performed. Data can be viewed and edited in the field before it is sent on to a CADD platform--see Figure 11-7 below.

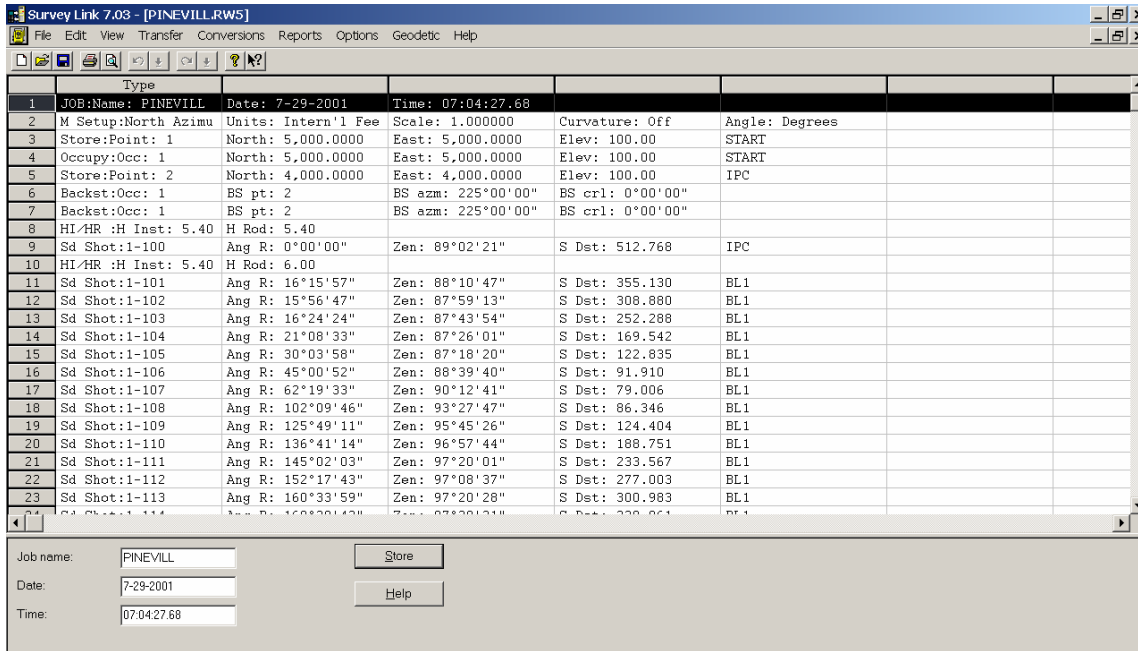

Figure 11-7. Editing total station raw data file in TDS Survey Link 7.03

Listed below are some software considerations to install on field computer systems. Some of these features may also be available on the data collector.

- Interface with field data collector.
- A system of predefined codes for most common objects and operations in a database.
- User-defined codes for site-specific requirements in a database.
- Survey adjustment programs such as:

- *Compass rule adjustment*
- *Transit rule adjustment*
- *Crandall method*
- *Least squares*
- *Angle adjustment*
- *Distance adjustment*

- Include a program which can assign an alphanumeric descriptor field for each survey point.
- Include a full-screen editor to examine and edit ASCII data files.
- Have an interface program to convert files to common graphic interchange formats such as IGES or DXF.
- A program to connect features which were not recorded in order such as fence, curb and gutter, edge of pavement, waterline etc.
 - Provide an operating system which will be compatible with post-processing machines with CADD programs such as MicroStation or AutoCAD.
 - Custom programs which can use all the features available to the total station or the data collector.
- Select software which provides training if possible.

11-7. Field Quality Control and Quality Assurance Checks

a. Backups. Upon the completion of the file transfer, make a backup copy of the raw data. Once this transfer is complete, and only after this transfer is complete, then the data in the data collector can be deleted.

b. Hard copy prints. Print a copy of the formatted data and check it against the field notes. Check the field input of data against the field notes. Specifically, check the instrument locations, azimuths to backsights, and the elevation of benchmarks. Also scan the data for any information that seems to be out of order. Check rod heights.

c. Edit the data. Eliminate any information that was flagged in the field as being in error. In the system, make a record of any edits, insertions, deletions, who made them, and when they were made.

d. Process the control data. Produce a short report of the data that were collected in the field. Check the benchmark elevation to be certain that the given elevation is the calculated elevation and that the coordinates of the backsights and foresights are correct.

e. Data quality. To assure that complete data are being supplied by the field, make certain that the field crew fully understands the automated processes that are being used and that they take care to gather data appropriately. It is much easier and more productive for the field crew to get a few extra shots where they know there will be difficulty in generating a good contour map than it will be for those in the office to determine where certain shots should have been made and add them to the database. The field crew must also make sure they pick up all breaklines necessary to produce the final map.

f. Terrain contouring. The field crew will need to become educated about the contouring package used by the District Office. As the data are brought in from the first few projects, and periodically thereafter, the crew should observe the product produced by the contouring program. This will help them to understand where and what amount of data may be needed to get the best results. The District Office staff needs to be aware that in some circumstances the field crew may have difficulty in getting some information (terrain restrictions, traffic, etc.).

g. Field edit. The person responsible for the field work should be involved in the initial phase of editing because he or she will most likely remember what took place. Preferably, the editing should be done the same day the data are gathered, while the field person's memory is still fresh. If it is not possible for someone to walk the site to ensure that the final map matches the actual conditions, then the field person should be the one to review the map. Figure 11-8 shows one example by which processed data can be checked for quality.

Survey Link 7.03 - [pinevill.cr5]

File Edit View Transfer Conversions Reports Options Geodetic Help

Point #	Northing	Easting	Elevation	Description
1	5,000.0000	5,000.0000	100.00	START
2	4,000.0000	4,000.0000	100.00	IPC
100	4,637.4693	4,637.4693	108.60	IPC
101	4,829.3587	4,688.7580	110.68	BL1
102	4,850.0919	4,730.1543	110.25	BL1
103	4,879.3522	4,778.6550	109.39	BL1
104	4,931.4953	4,845.1002	106.99	BL1
105	4,968.3799	4,881.4451	105.17	BL1
106	5,000.0232	4,908.1151	101.55	BL1
107	5,023.5282	4,924.5793	99.11	BL1
108	5,072.4167	4,953.2640	94.18	BL1
109	5,122.1911	4,980.2525	86.92	BL1
110	5,187.2780	5,005.5165	76.52	BL1
111	5,228.1130	5,040.3627	69.59	BL1
112	5,262.4254	5,081.7127	64.95	BL1
113	5,269.2869	5,128.8265	60.94	BL1
114	5,273.5494	5,181.0260	56.16	BL1
115	5,277.7984	5,196.3265	55.02	BL1
116	5,273.0016	5,201.0169	52.51	DITCHX
117	5,269.8548	5,181.9033	54.83	DITCH
118	5,263.7558	5,118.3752	60.72	DITCH
119	5,257.5688	5,083.0463	63.98	DITCH
120	5,240.6447	5,056.1597	66.87	DITCH
121	5,215.5491	5,035.0282	69.94	DITCH
122	5,180.7661	5,006.3230	74.84	DITCH
123	5,128.0428	4,984.9012	83.54	DITCH

Point number: 1

Northing:

Easting:

Elevation:

Description:

Figure 11-8. Reviewing final X-Y-Z coordinate files (Survey Link 7.03)

Figure 11-9 below depicts feature and attribute assignments on one of the objects (“FH” -- fire hydrant) that were imported into a Trimble Geomatics Office (TGO) software display.

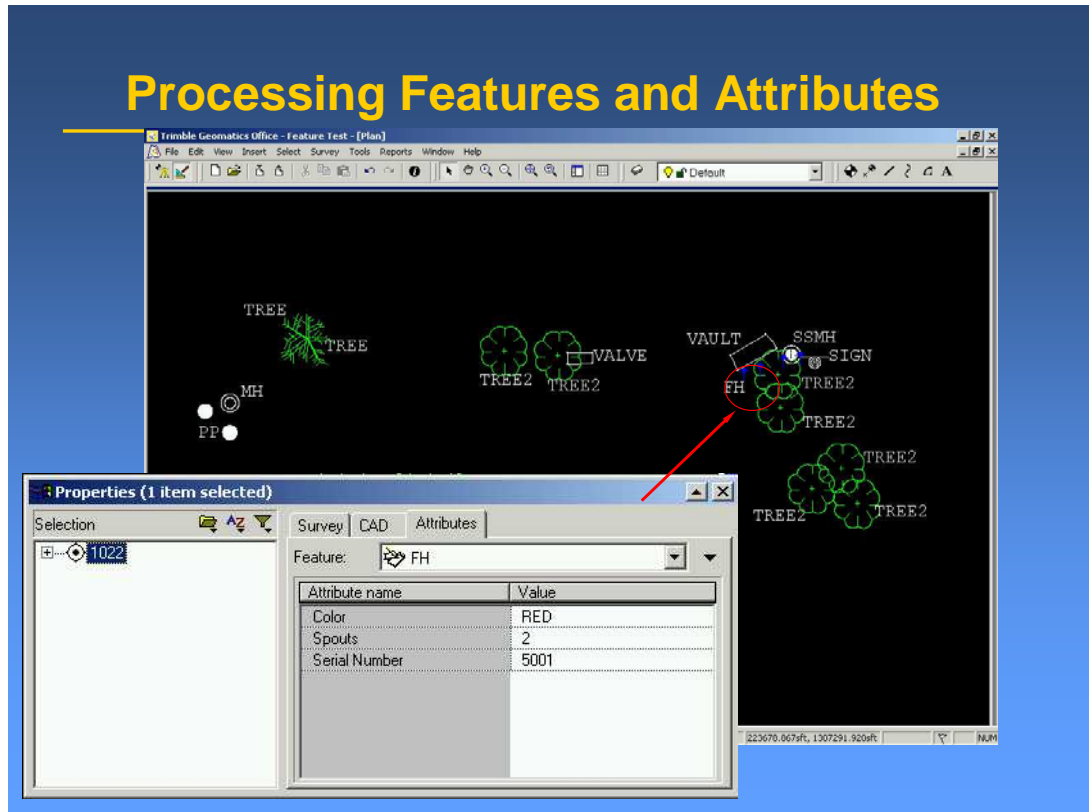

Figure 11-9. Feature and attribute coding--Trimble Geomatics Office (David Evans & Associates)

11-8. Cell Libraries Containing Corps of Engineers Standardized Symbology

A “cell” in MicroStation and a “block” in AutoCAD are groups of graphical elements that can be manipulated as a single entity. Examples of cells/blocks are hydrants, poles, benchmarks, etc. The use of such symbology enhances CADD productivity and provides an excellent opportunity for CADD standardization. MicroStation cells are contained in cell libraries (.cel) and custom line styles contained in resource files (.rsc). AutoCAD blocks are in an individual drawing (.dwg) file, patterns in a pattern library file (.pat), multilines in a multiline library file (.mln), and custom line styles in a line type library file (.lin).

a. Graphical presentations of the entire symbology library are shown in Appendix D of the A/E/C CADD Standard. The symbology library contains four types of elements: Lines, Patterns, Symbols, and Objects. Lines are defined as a graphical representation of linear drawing features (e.g., utility lines, fence lines, contours). Patterns are defined as repeated drawing elements (e.g., lines, dots, circles) within a defined area. Symbols are defined as MicroStation cells or AutoCAD blocks that are representative of objects (e.g., electrical outlets, smoke detectors). Objects are defined as MicroStation cells or AutoCAD blocks that retain their actual size no matter the scale of the drawing.

b. Figure 11-10 below depicts a portion of the surveying and mapping symbols published in the CADD/GIS Technology Center “A/E/C CADD Standard”--ERDC/ITL TR-01-6 (Appendix D--Symbology).

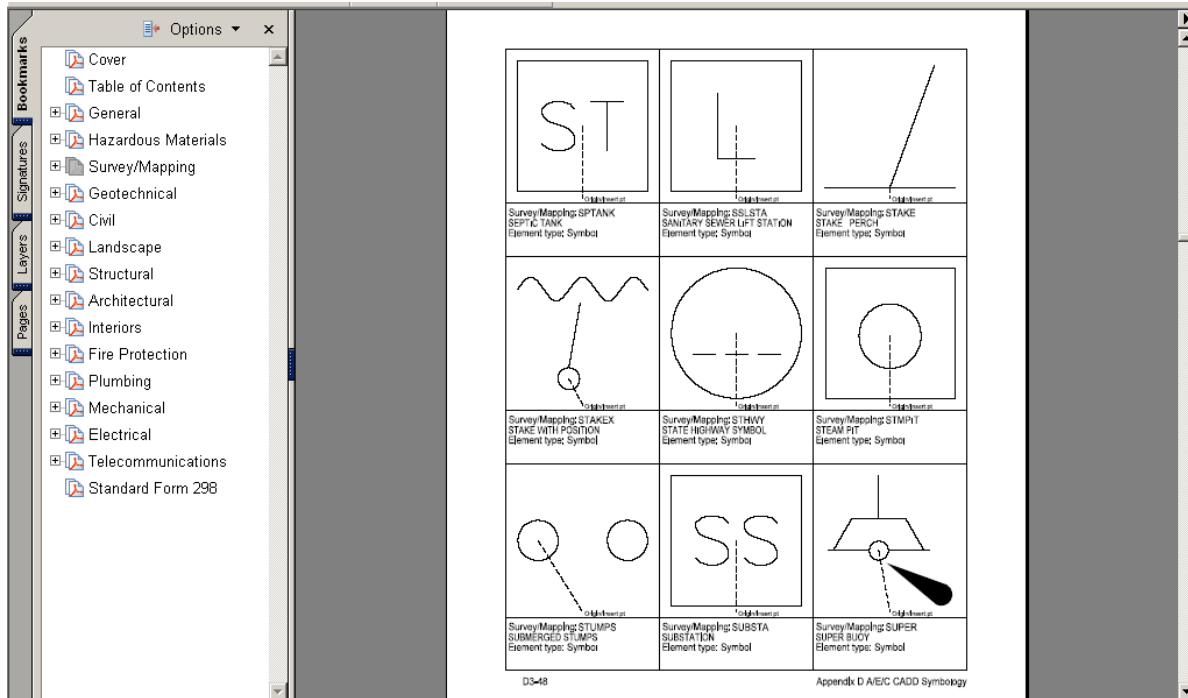

Figure 11-10. Portion of A/E/C CADD Standard surveying and mapping symbology listing

11-9. Sheet and Model Files

A model file contains the physical components of a building (e.g., columns, walls, windows, ductwork, piping, etc.). Model files are drawn at full scale and typically represent plans, elevations, sections, etc. A sheet file is synonymous with a plotted CADD drawing file. A sheet file is a selected view or portion of the model file(s) within a border sheet. A sheet file is a view or portion of an assembly of referenced model files plus additional sheet-specific information (e.g., north arrows, scales, section cuts, title block information). A sheet file is the final project sheet, which is a “ready-to-plot” CADD file within a border sheet and is usually plotted at a particular scale, since the border sheet is scaled up to fit around the full-scale model files.

11-10. Reference Files

Reference files (external references or XREFs) enable designers to share drawing information electronically, eliminating the need to exchange hard copy drawings between the design disciplines. With the use of reference files, the structural engineer need not wait for the architect to complete the architectural floor plans before beginning the structural framing plan model file. Nor does the engineer have to redraw the architect’s structural walls on the structural framing plan model file. Referencing electronic drawing information makes any future changes made by the architect apparent to the structural designer. This real-time access to the work of others ensures accuracy and consistency within a set of drawings and helps promote concurrent design efforts. No longer does one discipline have to wait until another discipline is nearly finished before they begin their drawings. The use of reference files is a key component in the successful use of the level/layer assignments. To create either a model file or a final sheet file, multiple referenced model files may be required.

11-11. Level Assignments for Surveying and Mapping

The following table depicts the “standard” 63 level assignments used for surveying & mapping features in many Districts of the Corps of Engineers.

Level	Description	Color	Weight	Line Code
1	Sheet Dependant Information			
2	Coordinate Grid/ Neat Box / N. Arrow	2	0	0
3	Coordinate Grid / Annotation	2	0	0
4	Buildings	4	2	0
5	Building Annotation	4	0	0
6	Centerline	3	0	4
7	Road, Railroad and Centerline Annotation	4	0	0
8	Roads, Parking Lots, Walks, Railroads, and Trails	4	1	
9	Concrete Joint Layout	4	0	0
10	Concrete Joint Elevations	4	0	0
11	Runway, Taxiway, and Aprons	5	1	0
12	Runway Annotation	5	0	0
13	Pavement Markings and Signs	5	0	0
14	Structures and Headwalls	6	1	0
15	Structure Annotation	6	0	0
16	Culverts	6	1	0
17	Culvert Annotation	4	0	0
18	Riprap	2	1	0
19	Water Features	1	0	0
20	Water Feature Annotation	1	5	0
21	Vegetation	2	0	0
22	Vegetation Annotation	2	0	0
23	Fences, Guard Rails	1	0	0
24	Fence Annotation	1	0	0
25	Boundary Lines / Cadastral-R/W	6	2	0
26	Boundary Lines / Cadastral / Annotation	6	0	0
27	Survey Control Points, Baselines	5	1	0
28	Survey Control Points / Azimuths	5	0	0
29	Breaklines	4	0	0
30	Spot Elevation	4	0	0
31	Major Contours	6	2	0
32	Contour Annotation	6	0	0
33	Minor Contours	3	0	0
34	Bores, Holes, and Text	6	0	0
35	Storm Sewerlines and Manholes	2	0	0
36	Storm Sewer Annotation	2	0	0
37	Sanitary Sewerlines, and Manholes	4	0	0
38	Sanitary Annotation	4	0	0
39	Water Lines, Fire Hydrants, and Water Tanks	1	0	0
40	Waterline Annotation	1	0	0
41	Gaslines, Features, and Valves	3	0	0
42	Gasline Annotation	3	0	0
43	Powerlines, Lights, and Telephone Poles	5	0	2
44	Powerline Annotation	5	0	0
45	Steamlines, Features, and Valves	6	0	0
46	Steamline Annotation	6	0	0
47	Cross Sections and Profiles	4	0	0
48	Details, Inserts		0	0
49	Soundings	1	0	0
50	Channel Lines, Disposal Areas	3	5	3
51	Channel Line Annotation		5	0
52	Navigation Aides and Annotation	6	1	0
53	Levees, Dikes, and Annotation	4	1	0
54	Pipe Lines, Structures, and Bridges	6	1	0
55	Pipe Line Annotation	6	0	0
56	Stationing and Ranges	5	1	0
57	Revetments and Annotation	2	0	0
58	Match Lines	3	1	0
59	Match Line Annotation	3	5	0
60	Unassigned			
61	Unassigned	3	2	0
62	Unassigned			
63	Unassigned			

Chapter 12 Survey Documentation and Submittals

12-1. General

This chapter provides guidance on survey documentation, such as field notes, deliverables, metadata, and final submittal reports generated for a topographic survey project, such as a site survey, control survey, hydrographic survey, or construction measurement and payment survey. Generally, a project report is prepared for every major surveying project; in particular, those projects involving new work. Less formal letter reports will usually suffice for routine or repetitive construction surveys. Contract survey specifications will indicate when a formal report is required. This narrative report should describe all salient events and procedures involved in the project. The report will outline all submittals or deliverables attached with the report, to include: raw data files (GPS, data collector), coordinate files, design files (*.dgn), ESRI shape files, sheet index files, hard-copy drawings, quantity take-off computations, etc. In addition, any QC and/or QA procedures should be described. If real property surveys are involved requiring filing in local jurisdictions, then appropriate licensing certifications must be made on the submitted drawings. FEMA or FAA certifications will require survey reports to be submitted in that agency's format.

12-2. Final Survey Report Format--Civil Works

A standardized report format should be used for all major survey projects--especially those for planned design and construction. A project report submitted in a consistent format provides essential background information to the design engineer. The following outline may be used for guidance in preparing a survey report on a topographic survey.

Outline for Survey Report Submittals

Section 1: General Project Description

Overview of the project including location, purpose, and parties involved.

Section 2: Background

Reason for project (more detailed description) and more specific location description including a map. Accuracy and deliverables should be discussed in this section. Attach or include a copy of the original Scope of Work prepared by the originator. Add funding information if applicable.

Section 3: Project Planning

How the project was planned including but not limited to: reconnaissance results; control establishment; datums; DGPS method(s) selected; topographic survey techniques; feature and attribute standards selected.

Section 4: Data Collection

Overview of how data was collected including but not limited to: Equipment used (make and model); data collection method(s) and/or techniques used; control points used; amount of data collected; number of crews and personnel per crew; how long the data collection took; data processing/error checking performed in field.

Section 5: Primary Control Data Processing

How the control data processing was performed including but not limited to process followed.

Subsection 5-1: Total station Traversing--adjustment software, results, closures, final adjustment results and coordinate listings.

Subsection 5.2: GPS Control Surveys & Baseline Processing--Software used; baseline processing results (summary); reprocessed baselines and reason for; parameters for baseline processing (elevation mask, type of ephemeris used); summary results or loop closures (if applicable).

Subsection 5.3: Combined GPS, Total Station, Differential Leveling Network Adjustments---Software used; results of unconstrained adjustment, minimal constrained adjustment, and fully constrained adjustment; summary of weights used, general statistics.

Section 6: Project Summary and Conclusion

This section shall include overall results of the processing, products produced, listing of deliverables being submitted, list of metadata files submitted, overall accuracy of the data collection (based on results from data processing section), problems encountered during data collection and data processing, recommendations for future data collection efforts of this type or in this area (lessons learned).

Section 7: Output and Reports from Software

This section shall include the detailed reports and output from software packages used during the data processing. This section might have multiple subsections--e.g., one for each step in the processing that has output that is critical in evaluating results.

12-3. Final Survey Report Format--Military

FM 3-34.331 recommends the following format be utilized for final project reports involving military facilities. The guidance and report outline is excerpted from FM 3-34.331.

An end-of-project report is used to inform the commander and the customer that the project has been completed. The results of the project will generally be listed on DA Form 1962. Copies of DA Form 1959, map overlays, and other graphics may be included. The report should be broken down into readily identifiable numbered and titled paragraphs, as follows:

- Paragraph 1. References. A complete listing of all orders, letters, project directives, and memorandums for record (MFRs) concerning the project. Normally, the other reports will not be listed as references.
 - Paragraph 2. Personnel. The name and rank of all personnel participating in the project. The inclusive dates of their involvement should also be listed. This paragraph can be further broken down as follows:
 - Field-crew personnel from the parent unit.
 - Visiting or inspecting personnel (the unit or office should also be included).
 - Local officials directly involved in the project.
 - Paragraph 3. Objective. The specific mission statement.
 - Paragraph 4. Discussion. A detailed discussion of exactly what transpired during the conduct of the project. Specific dates and details should be included. The milestone objectives outlined in the recon report should be discussed. Indicate whether the project was kept on schedule, or fully explain the reasons for falling behind schedule.
 - Paragraph 5. Problem Areas. Specific problem areas and the solutions to the problems. This information becomes a historical record to be used for future planning purposes. Technical information will be included in the narrative and graphic sections of the recon report.
 - Paragraph 6. Funding. All fund citations and a total of all funds expended. The ISVT and recon reports are the sources for this information. Copies of all travel vouchers and other expenses should be included.
 - Paragraph 7. Work Hours. The total number of expended work hours (broken down by rank). A composite of all progress reports should be included.
 - Paragraph 8. Conclusions and Recommendations. Cite specific conclusions and recommendations.
-

Examples of final survey reports submitted by an AE contractor and Corps in-house staff are included in the application projects in some of the appendices to this manual. Although these reports do not conform to the above formats, they do include the same general information.

12-4. Field Note Keeping Procedures and Formats

Field notes will supplement digital data records. Typically all field notes will be recorded in a standard, bound, hardcover surveyor's field book as the measurements are made in the field.

a. *Entries.* All field note entries shall be made with a black lead pencil or ink. Notations made by other than the original surveyor shall be made with a colored pencil so a clear distinction exists between the field observations and subsequent corrections, adjustments, comments or supplemental data.

b. *Index.* The first two (or more) pages of each field book shall be reserved for the index and shall be annotated with Roman numerals. An index entry shall be made for each day. The index should contain the date and description of the survey, Project or Contract number, the type of survey, and the page numbers containing the survey data. The remainder of the field book shall contain the actual field data and shall be numbered beginning at page one. A sample field book index is shown in Figure 12-1 below.

Pg. #	Index		
I	Title Page		
III	Sketch of Job site		
1-30	TRANSVERSE		
31-33	Check Levels c. 3rd Order Levels To B/L		
34-36	Topo - Data Collection		
37	X-Section 0+00		
38	X-Section 1+00		
39	" " 2+00		
40	" " 3+00		
41	" " 4+00		
42	" " 5+00		
43	" " 6+00		
44	" " 7+00		
45	" " 7+92.34		
46	Topo Data Collection		

Figure 12-1. Sample index page in a field survey book (Vicksburg District)

c. *Title page.* A separate Title Page shall be prepared for each day's work, or partial days work if applicable. The Title Page shall be referenced in the field book Index. The Title Page shall contain all pertinent information about the survey--project, contract number, personnel, weather, instruments used, etc. An example of a comprehensively detailed title page is shown in Figure 12-2 below.

①

PARTY: CFC TECHNOLOGIES, INC. JOB # 7322 9-23-04
KEN CORNER - P.C., NOTES, T1 P.C. EWARTH
PAIGE MELANCON - PROJECT MANAGER
ERIC QUIRK - CAD / INST. / ROD
SAM ALLEMAN - MULTI-BEAM OPERATOR
BILL BERGEN - USACE CONSULTANT
DAVID ROBAR - USACE ASST. CHIEF OF SURVEY

KEY WEST, FLORIDA
US ARMY CORPS OF ENGINEERS
JACKSONVILLE DISTRICT
DREDGING 34-FOOT PROJECT
MAIN SHIP CHANNEL, CUT-A, CUT-B, CUT-C
& TRUMAN HARBOR
CONST. CONTRACT NO. DACW17-03-C-0001
DREDGE CONTRACTOR - BEAN-STY.
SUB-CONTRACT TO JOHNSON-MCADAMS
CONTRACT NO. DACW17-01-D-0003
TASK ORDER: 20 SURVEY NO. 04-030
T1: SOKKA BEO AUTOMATIC LEVEL, LEICA 500 GPS RTK
SYSTEM w/ CARLSON DATA COLLECTOR

HORIZ DATUM: NAD '83 ZONE: FLORIDA EAST
VERTICAL DATUM: MLLW UNITS: FEET US
- EPOCH 1960 - 1978 (LEVELS)
RTK = NAVD '88 236

Figure 12-2. Sample Title Page in a field survey book (Jacksonville District)

d. *Page setup.* The first page of each entry should contain (at the top left side of the page) the name of the installation or project location, a specific project title, and the type of work being done. At the top of the right half of the right half of the page, record the actual date of the survey, weather conditions, type and serial number of instruments used, members of the crew and their assignment, map or field book references, and

other remarks as necessary for a complete understanding of the survey. Pages are numbered on the right hand page only.

e. Corrections. No erasures should be made in the field book. If errors are made, they will be crossed through and the corrections will be entered ensuring that the original data remains legible. No figure should be written over the top of another-- nor should any figure be erased. If a whole page is in error, the complete page will be lined or crossed through and the word "VOID" will be written in large letters diagonally across the page. An explanation of the error, and a cross-reference will be entered on the voided page showing the book and page number where the correct information may be found. At the end of each day of work, the field notes shall be signed and dated by the individual responsible for the work.

f. Data collector. If a data collector is used, the basic setup information (station description, HI, sketch, etc.) needs to be recorded in the field book. This information is used to document the sequence of the survey. Sketches are added in the field book as needed to supplement the data collector and aid the CADD technician with the planimetric features. On some critical projects (e.g., boundary location, construction payment surveys, etc.) it may be prudent to duplicate digitally recorded data in the field book as it is observed. The requirement for such duplicative recording will depend on the nature of the project, including factors such as potential contract disputes and claims, boundary encroachments, etc.

g. References. When it is necessary to copy information from another field book or other source, a note will be made which clearly states that the information was copied and the source from which it came. If the notes are a continuation from another field book, a description will be written in the field book to the effect "NOTES CONTINUED FROM BK XXXX PAGE XX." A similar description (e.g., CONTINUED IN BOOK XXXX FROM PAGE XX) will be written on the last page of each section of notes if those notes are to be continued either in another book or on another page that is not adjacent to the current page.

h. Sketches. Sketches are absolutely essential on many site plan surveys, especially if complex utility details are involved. The sketch should show all the details, dimensions, and explanatory notes required. The sketch should be written on a whole page whenever possible. If necessary, multiple pages with the sketch divided equally among the pages should be used if the sketch has too many details to be shown on one page.

i. Digital photos. Sketches and other data may be supplemented by digital photos taken in the field. Photos are often useful of permanent control monuments occupied, utility access covers/boxes, utility identification signs, sample vegetation and tree cover, culverts, bridges, towers, etc. References to digital photos should be made in the field book or data collector.

j. Descriptive project data. Field book records must contain sufficient descriptive notes so that the survey can be easily reconstructed by different personnel or at any later point in time. Thus, it is important to describe the starting horizontal and vertical control points and their coordinate values. Problems or control discrepancies should be clearly noted in the field book. Sketches of traverse or level routes should be drawn in the field book. Instruments used should be identified. All the forgoing applies whether or not a data collector system is used. Figure 12-3 below depicts a portion of a field book that describes the initial base station set up parameters for a RTK survey. Such basic information is critical in the event the subsequent RTK survey data is questioned.

k. Project archives. In general, a separate field book should be initiated for each design or construction project. Field books should be copied or scanned as soon as possible after the field work is completed. The original book should be submitted with the deliverables for permanent retention by the District office.

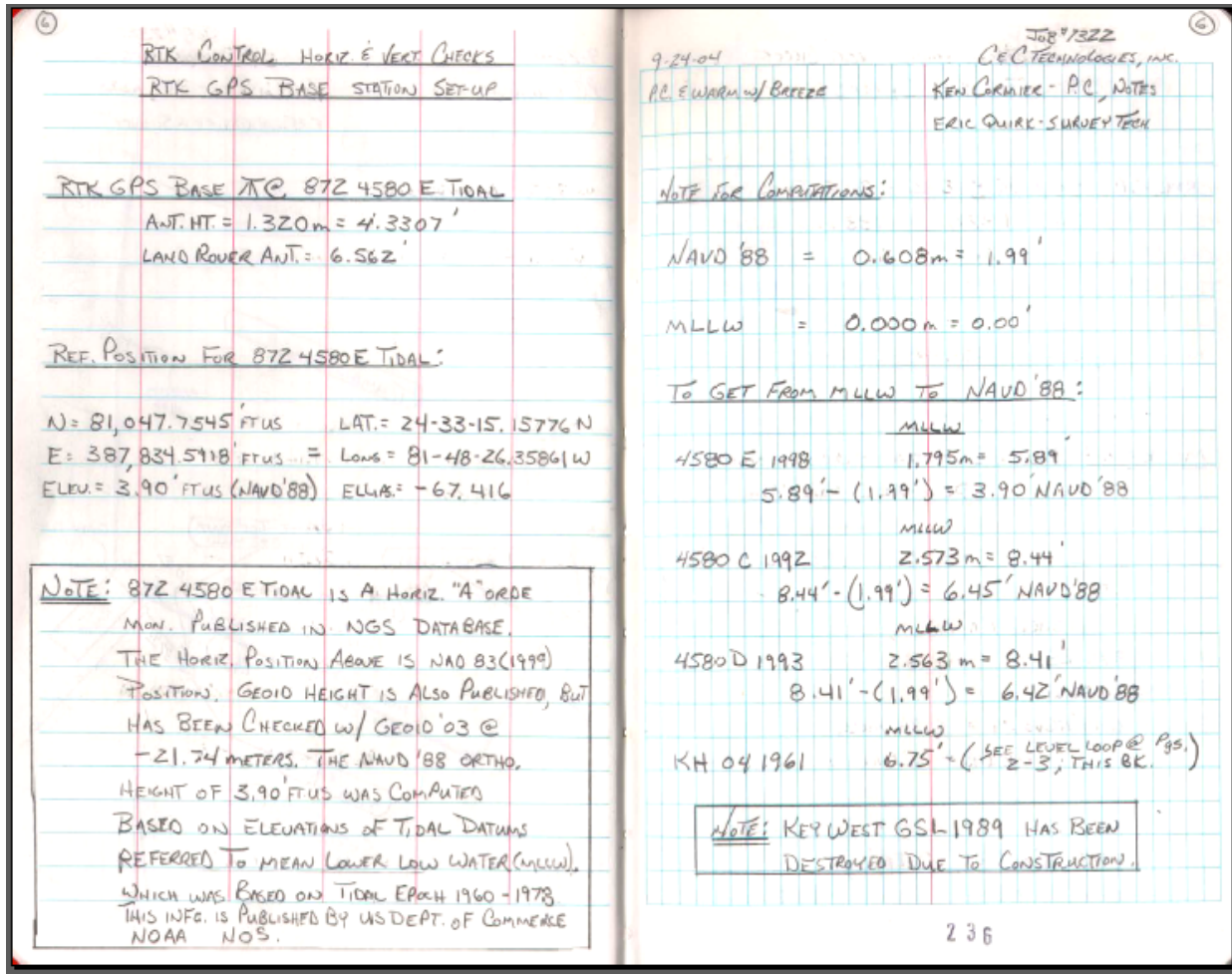

Figure 12-3. RTK reference notes in a field survey book (Jacksonville District--C&C Technologies, Inc.)

12-5. Sample Topographic Survey Field Book Notes

There is no set format for topographic field notes. The amount of detail required in the field book will depend on the nature of the project. When a data collector is used with a total station or RTK, then only minimal file referencing data is needed in the field book, as illustrated in Figure 12-4 below.

"Topo"				08-23-02		34
File: ARK-1-DCG - DATA Collection						
PT. #	CODE	ROD				
Ne PT. #9 (mu=5.58)						
BS PT. #10	00000	5.31			ELEV	
101	CHK-IN	5.31			ERRORS	-0.001
① 23	2703	5.27	TURN			
102	CHK-IN	5.31	N. E.		ELEV	
					ERRORS	+0.003 +0.009 +0.001
Ne PT. #23 (mu=5.36)						
BS PT. #9	0000-00	5.50			ELEV	
103	CHK-IN	5.50			ERRORS	-0.002
104	2706	6.10				
105	2706	6.10				
106-151	0801	6.10	Line # 1			
152-166	1801	6.10	Line # 2			
167-201	1910	6.10	Line # 3			
202-205	1801	6.10	Line # 4			
206-213	1801	6.10	Line # 5			
214-215	1601	6.10	Line # 6			
216-239	3001	6.10				
240-261	1802	6.10				
262-	3000	6.10				
263	1601	6.10				
264-267	1801	6.10	Line # 7			

= AB-7 = 0+00	3/4" Iron Rod
= AB-8 = 4+56 1/2	3/4" Iron Rod
= PT. #10 = AB-8 = 4+56 1/2	3/4" Iron Rod
= AB-7-1	Hub Stake
= PT. #10 = AB-8 = 4+56 1/2	3/4" Iron Rod
= AB-7-1	Hub Stake
= AB-7 = 0+00	3/4" Iron Rod
= PT. #9 = AB-7 = 0+00	" "
ROD IN TOP OF CONC. ON LT BANK DOWNSTREAM WALL OF STRUCTURE	
ROD IN TOP OF CONC. ON RT BANK DOWNSTREAM WALL OF STRUCTURE	
Edge of Sigs Road ON TOP of RIP RAP	
Edge of RIP RAP	
Waters Edge	
Edge Rip Rap	
Edge Rip Rap	
Invert Round Culvert 36" Round Iron Pipe	
Nat. Ground on DIRT	
Station Rip Rap	
Top Drop Inlet 2 1/2 X 2 1/2	
Invert 24" Round Conc. Pipe	
Edge Rip Rap	

Figure 12-4. Topographic survey notes referencing data collector shots (Vicksburg District)

When topographic observations are manually recorded, a variety of field book formats may be used. The particular format selected will depend on the note keeper's preferences, the type of project, densification method (radial, cross-sections, or linear profiles), type of instrument, and amount of descriptor data required for individual shots. The surveying texts listed in Appendix A provide examples of topographic survey notes—particularly Kavanagh 1997 and many of the state DOT manuals. Some representative examples of topographic field notes are shown on the following Figures 12-5 through 12-8.

⊕ Profile - Road A 10/20/85

Sta.	+	HI	-	Elev.	Adj. Elev.		(27)
TBM#3	11.80	189.68			171.88	TBM#3 is nail in roof of 24" water pipe, set in June 1975 - Book 42-12	
13+00			9.40				
13+89			4.96				
13+96			4.60				
14+00			4.40			X-SEC. # 3B	
14+49			2.11				
TP			1.03	182.65	182.66		
	9.94	192.52					
15+00			8.61			X-SEC. # 4	
15+19			7.66				
16+00			3.38			X-SEC. # 5	
16+47			0.88				
TBM#4			0.81	191.78	191.80	TBM#4 is RP spike set in pavement, Set June 1975 - Book 42-12	
	11.45	203.75					
17+00			8.87			SAMPLE NOTES - PROFILE	
18+00			3.80			ON EXISTING PAVEMENT	

Figure 12-5. Sample notes from a road profile survey--setting elevations on intermediate stations

X-SECTION STA 0+00 L-8 10
13 SEPT 87

RANGE	+	HI	-	ROD	ELEV		
	4.00	14.00			10.00	"FCSJ-2120" (PUBLISHED NEVD 1929)	
200				3.9		B/L AND TOP OF LEVEE	
25				6.0		SLOPE	
30				8.0		BREAK	
34				9.9		SLOPE	
50				10.0		SLOPE	
75				12.5		SLOPE	
300				14.5		SLOPE	
			13.55		0.45	T.P. (2x2 HUB)	
	3.55	4.00					
17.5				3.6		TOE OF LEVEE	
1.50				3.6		MARSH (GRASS + WATER)	
1.25				3.6		MARSH (GRASS + WATER)	
			2.25		1.75	"FCSJ-2119" (PUBLISHED ELEV 1.74)	

Figure 12-6. Sample notes from a levee cross-section survey

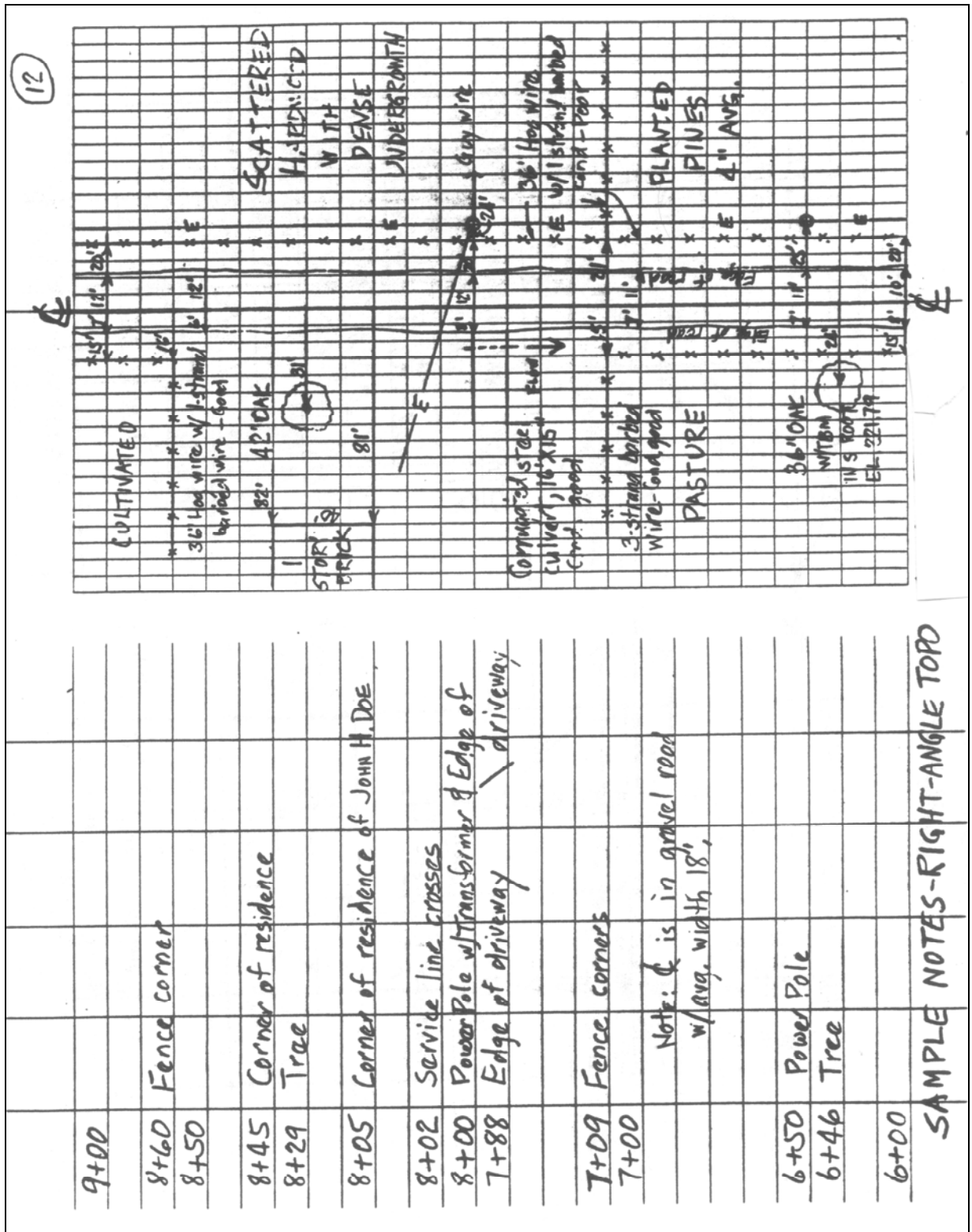

Figure 12-7. Notes from a right-angle topographic survey along a road centerline

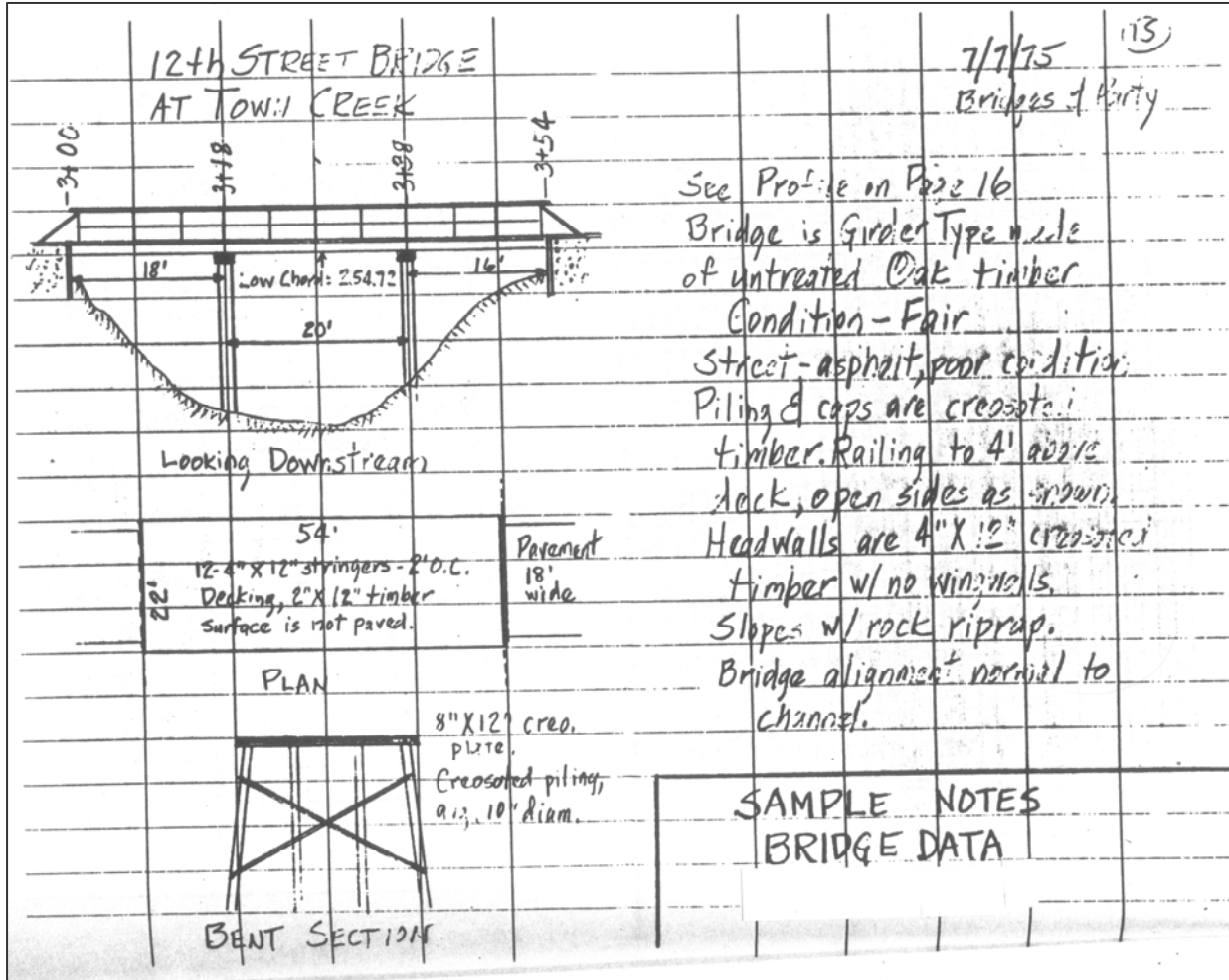

Figure 12-8. Sample notes from a bridge survey

12-6. Monument Descriptions

A description of the point occupied shall be made in the field notes. This description shall include the type of monument, its general location, and the type of material the point is set in. A sketch of the location of the point relative to existing physical features and reference ties shall be made and included in the notes. If a horizontal control line is used, a sketch of it shall be made and included in the notes. This sketch does not need to drawn to scale, but it should include the relative position of one point to the next and the basic control used. Alternatively, DA Form 1959 (Description and Recovery of Horizontal Control Station) may be used to record descriptions of permanent control monuments. A sample DA Form 1959 is shown at Figure 3-1 in Chapter 3. Optionally, a digital photo or "rubbing" of a monument may be obtained and submitted.

12-7. Standardized Coordinate File Coding (New Orleans District)

This section describes a coding scheme used by New Orleans District that is intended to define the general parameters associated with a survey project. This coding format is a mandatory submittal item for AE contractors performing surveys in New Orleans District. These code records are inserted into the ASCII coordinate file produced by the data collector and were developed for general USACE topo survey requirements. These records are used when importing the data into a GIS to create the required Metadata file. Additional codes may need to be developed to suit particular applications. All code records will begin with a “ # ” in column 1, and are limited to 80 characters (4 for the code, 1 space, and 75 for text). All comment records will begin with a “;” in column 1, and are also limited to 80 characters. The submitted file is in chronological order thus the code records will define the attributes of the records that follow. If the field data collection was completed in 7 days, the file would contain 7 #H02 records. Each would be placed at the beginning of the data collected on that day in indicate that the following records were collected on that date.

INDEX OF RECORD CODES

- | | |
|---|--|
| #B01 - Coordinates and station of baseline PI. | #H11 - Page number of field book specified by previous #H10 code on which the following information is recorded. |
| #B00 - Name of ASCII coordinate file that contains the survey data. | #H12 - Combined scale factor. |
| #BC1 - Coordinates and station of point of curve for curve #1. | #H20 - Title of survey job. The survey title is limited to 75 characters per record. |
| #BT1 - Coordinates and station of point of tangent for curve #1. | #H21-H29 - Continuation of survey job title. |
| #BI2 - Coordinates of point of intersection for curve #2. | #H30 - Reserved for any comments about the survey job. The comments are limited to 75 characters per record. |
| #C01 - Party Chief. | #H31-H99 - Continuation of comments about the survey job. |
| #C02 - Instrument Man. | #I01 - Instrument. |
| #C03 - Rodman. | #I02 - Serial number. |
| #G01 - Staff gage code number supplied by USCOE. | #M01-M99 - Description of miscellaneous survey points that follow. |
| #G02 - Name of gage. | #P01 - The profile segment's beginning x-y coordinates and stationing. |
| #G03 - Water surface elevation as read on gage. | #P03 - Time of profile. Only needed if elevations of points are relative to prorated water surface. |
| #G04 - Time (1423) of gage reading based on 24 hr clock. | #P04 - Prorated water surface elevation used for elevation of points in profile. |
| #G10-G99 - Descriptions and or comments are limited to 75 characters per record. | #T01 - Name of temporary benchmark (TBM). |
| #H01 - Standard DOS file name of ASCII file which contains the survey data. More than one file is allowed per survey job. | #T02 - Given elevation of TBM. |
| #H02 - Date (MM/DD/YY) on which the following information was obtained. | #T05 - Condition of TBM. |
| #H03 - Order (accuracy) of survey. (1,2,3..AA). | #T06 - Found elevation of TBM. |
| #H04 - Horizontal datum on which the survey is referenced. (NAD-1927, NAD-1983, WGS-84,...). | #T10-T99 - Description of TBM. |
| #H05 - Job number of survey. (YY-JJJ). | #X01 - The range line definition which contains the end point coordinates, station, and name of the range. |
| #H06 - Unit of linear measure (FT, MT, MI, ...). | #X02 - Range code or index number. |
| #H07 - Map projection. Use standard list of projection codes (1702, 1703, ...). | #X03 - Time of cross-section. Only needed if elevations of points are relative to prorated water surface. |
| #H08 - Location of survey such as nearest town, river, channel, basin. More than one location is allowed per survey. | #X04 - Prorated water surface elevation used for elevation of points in cross-section. |
| #H09 - Survey firm or organization. | #W01 - Temperature. |
| #H10 - Index number of survey field book in which the following information is recorded. | |

EM 1110-1-1005
1 Jan 07

#W02 - Pressure.
#W03 - Humidity.
#W04 - Cloud conditions
(0-10%: clear
10-50%: scattered

50-90%: broken
90-100%: obscured)
#W05 - Wind speed.
#W06 - Wind direction
(N,S,E,W,NE,NW,SE,SW)

a. Survey job parameters. Header records are required to describe the survey job parameters such as Horizontal Datum, Units of Measure, Survey Date, Job Location, Survey Firm, etc. #H20 thru #H29 are reserved for job title. #H30 to #H99 are reserved for any comments about the survey job. Survey field book and page numbers shall be indicated on the #H12 and #H13 records. This allows for an easy reference to original field data.

#H01 - Standard DOS file name of ASCII file which contains the survey data. More than one file is allowed per survey job.
#H02 - Date (MM/DD/YY) on which the following information was obtained.
#H03 - Order (accuracy) of survey. (1,2,3..AA).
#H04 - Horizontal datum on which the survey is referenced. (NAD-1927, NAD-1983, WGS-84,...).
#H05 - Job number of survey. (YY-JJJ).
#H06 - Unit of linear measure (FT, MT, MI, ...).
#H07 - Map projection. Use standard list of projection codes (1702, 1703, ...).
#H08 - Location of survey such as nearest town, river, channel, basin. More than one location is allowed per survey.
#H09 - Survey firm or organization.
#H10 - Index number of survey field book in which the following information is recorded.
#H11 - Page number of field book specified by previous #H10 code on which the following information is recorded.
#H12 - Combined scale factor.
#H20 - Title of survey job. The survey title is limited to 75 characters per record.
#H21-#H29 - Continuation of survey job title.
#H30 - Reserved for any comments about the survey job. The comments are limited to 75 characters per record.
#H31-#H99 - Continuation of comments about the survey job.

b. Vertical control. All control points whether found or established must be described by control code records. Vertical control records are required to define the parameters such as Vertical Datum, Benchmark Name, Epoch, etc., used to determine the survey point elevations. These records are required at the beginning of a file and where the vertical parameters change such as when a different benchmark is used, a code is inserted to describe the mark.

#V01 - Name of permanent benchmark (PBM).
#V02 - Given elevation of PBM.
#V03 - Epoch (date of adjustment).
#V05 - Condition of PBM.
#V06 - Found elevation of PBM.
#V07 - Horizontal Position of PBM. (Northing, Easting or DDMMSS.SSSSS, DDDMMSS.SSSSS)
#V09 - Vertical adjustment (adjustment value to apply to following records).
#V10-#V99 - Description of PBM.

c. Temporary benchmarks (TBM). All TBMs used whether established or found must be defined with TBM records. The primary benchmark used to set the TBM will be assumed to be the previous #V01 record (V-Records). The date set will come from the last "H02" record. #T10 through #T99 are used for description of mark.

#T01 - Name of temporary benchmark (TBM).
#T02 - Given elevation of TBM.

#T05 - Condition of TBM.
#T06 - Found elevation of TBM.
#T10-#T99 - Description of TBM.

d. Baseline parameters. These records describe the reference baseline. If a baseline listing is available, the user may include the file name in the #B00 record. Each baseline PI is defined by its coordinates, station number, and PI name. Curve data are defined by #BC, #BI, and #BT records. These records define the coordinates, and station number of the Point of Curve, Point of Intersection, and Point of Tangent respectively.

#B00 - Name of ASCII coordinate file that contains the baseline data.
#B01 - Coordinates and station of baseline PI. (Northing, Easting, Station, PI)
#BC1 - Coordinates and station of point of curve for curve #1.
#BT1 - Coordinates and station of point of tangent for curve #1.
#BI1 - Coordinates of point of intersection for curve #1.

e. Survey crew members. Gage records are required each time a gage is read.

#C01 - Party Chief.
#C02 - Instrument Man.
#C03 - Rodman.

f. Water surface elevation. Gage records are required each time a gage is read.

#G01 - Staff gage code number supplied by USACE.
#G02 - Name of gage.
#G03 - Water surface elevation as read on gage.
#G04 - Time (1423) of gage reading based on 24 hr clock.
#G10-#G99 - Gage descriptions and or comments

g. Instrument records. These records are required to document the equipment used--Total Station, GPS Receiver, Level, etc.

#I01 - Instrument.
#I02 - Serial number.

h. Miscellaneous records. These records are required on miscellaneous shots. The record will contain a general description of the points that follow.

(M-RECORDS -- example)
#M01 Borehole locations at the south end of the ammo
#M02 plant located in the U.S. Army Reserve Complex
#M03 in Corn Bayou, La., near the WABPL.
#M01-M99 - Description of miscellaneous survey points that follow.

i. Profile parameters. Each reach of profile must be preceded by a #P01 record. If the profile contains sounding data controlled by a gage, a #P03 (time) and #P04 (elevation) record must be included showing the interpolated water surface elevation.

#P01 - The profile segment's beginning x-y coordinates and stationing.
#P03 - Time of profile. Only needed if elevations of points are relative to prorated water surface.
#P04 - Prorated water surface elevation used for elevation of points in profile.

j. Cross-section parameters. Each cross-section must be preceded by a #X01 record. If the section contains sounding data controlled by a gage, a #X03 (time) and #X04 (elevation) record must be included showing the interpolated water surface elevation.

EM 1110-1-1005
1 Jan 07

- #X01 - The range line definition which contains the end point coordinates, station, and name of the range.
- #X02 - Range code or index number.
- #X03 - Time of cross-section. Only needed if elevations of points are relative to prorated water surface.
- #X04 - Prorated water surface elevation used for elevation of points in cross-section.

k. Weather parameters. Observed weather conditions as directed in scope of work.

- #W01 - Temperature.
- #W02 - Pressure.
- #W03 - Humidity.
- #W04 - Cloud conditions
(0-10%: clear
10-50%: scattered
50-90%: broken
90-100%: obscured)
- #W05 - Wind speed.
- #W06 - Wind direction (N,S,E,W,NE,NW,SE,SW)

l. Standardized Coding of Data Set Records (New Orleans District). A data set is defined as a cross section, a profile, or a group of topo shots. A data set begins with the #M, #P, or #X code records. For example a cross section data set begins with the #X records and is terminated by any #M, #P, or #X record. In the following example, the section at station 740+60.00 includes points 14 through 36.

```
#X013662575.472 513846.972 3663420.478 514783.249 74068.00 U-038
14,513846.972800,3662575.472400,25.177800,CLL
15,513851.730690,3662579.729793,24.790555,FSC
16,513854.771424,3662582.450114,23.607343,CON
17,513861.896190,3662588.617533,20.473465,CON
18,513869.537809,3662595.353421,17.172052,CON
19,513870.695011,3662596.667041,16.935937,FST
20,513885.651015,3662609.886094,17.604381,GRN
21,513897.436845,3662620.505040,17.054901,FL
22,513908.146804,3662629.967624,17.636607,GRN
28,514012.307919,3662723.237411,18.174412,GRN
29,514030.276254,3662739.133536,18.048303,GRN
30,514045.890994,3662753.505709,17.817666,GRN
31,514053.518645,3662760.498189,17.489915,TBK
32,514056.229181,3662763.379132,15.895516,RAP
33,514062.253261,3662768.735739,12.501015,RAP
34,514068.531708,3662774.720419,8.722339,RAP
35,514073.817554,3662777.983519,4.021107,RAP
36,514076.573300,3662782.391800,2.350900,WE
#X01 3662546.513 513869.121 3663402.044 514818.226 74032.00 U-038A
37,513869.121300,3662546.513300,24.810400,CLL
38,513874.846108,3662551.522557,24.355463,FSC
39,513877.284808,3662553.713072,23.223493,CON
40,513884.216098,3662559.999895,20.291534,CON
41,513891.230399,3662566.338795,17.194674,CON
42,513892.695782,3662567.524053,16.967491,FST
43,513908.060337,3662581.755554,17.467846,GRN
44,513918.193497,3662590.318394,17.270104,FL
45,513931.191766,3662602.314157,17.485274,GRN
```

m. Sample Set of Encoded Records from a Topographic Survey (New Orleans District). The following archival data was created for a survey of a power line near Algiers, LA. This dataset was

generated by the AE contractor as part of his survey deliverable. The same dataset is then used to create a metadata file shown in a subsequent section.

```
#H01 04024LRP.EM
#H02 01-07-04
#H03 3
#H04 NAD83
#H05 04024
#H06 USFEET
#H07 1702
#H08 NEAR ALGIERS, LA.
#H09 CHUSTZ SURVEYING INC.
#H10 040012
#H11 1-75
#H12 1.0
#H20 FIELD DATA RE-COLLECTION OF CHALMETTE POWERLINE
#H30 W912P8-04-D-0001
#H31 Task Order 7
;
;
;-----VERTICAL CONTROL INFORMATION -----
;
#V01 Q 196
#V02 6.77
#V03 1996
#V04 LWRP 1993
#V05 Good
#V06 N/A
#V07 29-55-31 89-59-06
#V10 THE PID FOR THIS PBM IS AT0483
#V11 AS PER THE SCOPE OF WORK FOR THIS PROJECT, PBM Q 196
#V12 WAS TO BE USED FOR THE VERTICAL CONTROL ON THIS PROJECT
#V13 NOTE: THIS FILE HAS BEEN CORRECTED TO THE LWRP 1993 VALUES
#V14 BY ADDING 0.15 FT TO THE NAVD88 ELEVATION TO BRING IT TO
#V15 NGVD29, THEN SUBTRACTING THE LWRP 1993 VALUE OF 0.9 AS
#V16 PROVIDED IN THE SCOPE OF WORK TOTAL CORRECTION TO NAVD88
#V17 WIRE ELEVATION IS (-) 0.65 FT
;
;
;-----TEMPORARY BENCK MARKS-----
;
;
; ELEVATIONS WERE ESTABLISHED ON SEVERAL CONTROL POINTS
; BUT NO ACTUAL TBMS WERE ESTABLISHED ON THE PROJECT
;
;-----FIELD PERSONNEL-----
;
#C01 LEE HINES
#C01 MATHEW DELHOMME
#C02 JOHN TEMPLETON
#C03 ROGER GROS
#C03 GREGERY GROS
;
;-----EQUIPMENT-----
```

```
#E01 TOTAL STATION
#E02 LEICA T-1010
#E03 370556
;
#E01 LEVEL
#E02 TOPCON ATG3
#E03 5F6344
;
;
;-----WEATHER-----
;
;
#W01 64 F
#W02 30.5 inHg
#W03 40%
#W04 PARTLY CLOUDY
#W05 10-15 MPH
#W06 WNW
;
; NOTE: ADDITIONAL WEATHER RECORDS ARE IN THE FIELD BOOKS
```

12-8. Creating Metadata for Topographic Surveys

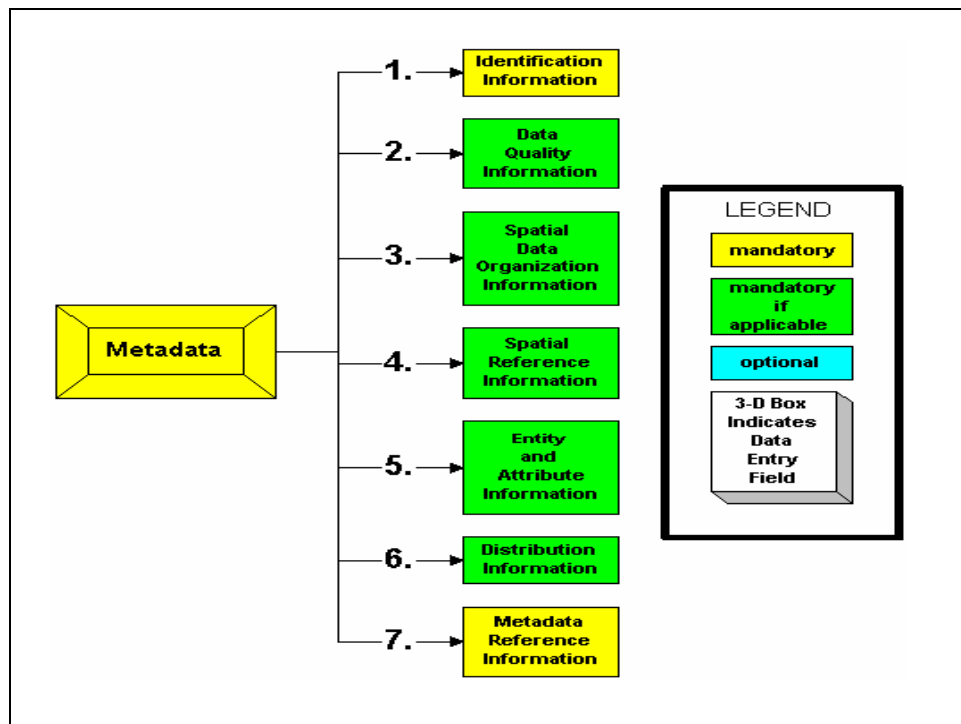

Figure 12-9. Mandatory and optional metadata fields

Metadata records should be created for topographic survey projects. The file structure is outlined in Figure 12-9 above. Only fields 1 and 7 are mandatory--2 through 6 are optional. Corps metadata policy and procedural references are contained in ER 1110-1-8156 (Policies, Guidance, and Requirements for Geospatial Data and Systems) and EM 1110-1-2909 (*Geospatial Data and Systems*). The following is a sample metadata file generated from the previously described New Orleans District power line survey.

Identification_Information:

Citation:

Citation_Information:

Originator: New Orleans District, U.S. Army Corps of Engineers

Publication_Date: JANUARY 6, 7, 15 and 16, 2004

Title: FIELD DATA RE-COLLECTION OF CHALMETTE POWERLINE

Publication_Information

Publication_Place: New Orleans, LA

Publisher: New Orleans District, U.S. Army Corps of Engineers

Online_Linkage:

<NONE>

Online_Linkage:

<NONE>

Description:

Abstract:

Resurvey of the Entergy power line crossing located at Mississippi River mile 89.2 AHP. The power lines were raised to facilitate the navigation of large cruise liners to the Port of New Orleans. The power lines were surveyed at a 75-foot interval and referenced to PBM Q-196 (AT0483). Note: this file has been corrected to the LWRP 1993 values by adding 0.15 ft to the NAVD88 elevation to bring it to NGVD29, then subtracting the LWRP 1993 value of 0.9 as provided in the scope of work.

Total correction to NAVD88 wire elevation is (-) 0.65 ft

Horizontal positions were relative to the levee marker survey traverse on the NAD83 datum.

Surveys were performed to document the elevations of the high tension

Purpose:

The power lines were hanging too low for the new cruise ship to safely cross under without striking. Documentation was required by the utility company and the cruise lines to determine the margin of safety under the raised wires.

Time_Period_of_Content:

Time_Period_Information:

Single_Date/Time:

Calendar_Date: JANUARY 6, 7, 15 and 16, 2004

Currentness_Reference: publication date

Status:

Progress: Complete

Maintenance_and_Update_Frequency: Daily.

Spatial_Domain:

Bounding_Coordinates:

West_Bounding_Coordinate: 3709150.07

East_Bounding_Coordinate: 3709460.65

North_Bounding_Coordinate: 523258.07

South_Bounding_Coordinate: 520243.34

Keywords:

Theme:

Theme_Keyword_Thesaurus: none

Theme_Keyword: Boundaries

Theme_Keyword: Hydrography

Theme_Keyword: Topography

Place:

Place_Keyword_Thesaurus: none

Place_Keyword: New Orleans

Place_Keyword: Louisiana

Place_Keyword: NEAR ALGIERS, LA.

Temporal:

Temporal_Keyword_Thesaurus: None

Temporal_Keyword: JANUARY 6, 7, 15 and 16, 2004

Access_Constraints:

None.

Use_Constraints:

This survey information is accurate as of the date of publication. Topographic-Hydrographic survey data is subject to change rapidly due to several factors including but not limited to dredging activity and natural shoaling scouring processes. The U. S. Army Corps of Engineers accepts no responsibility for changes in the conditions which develop after the date of publication. This information is intended for the internal use of the U. S. Army Corps of Engineers and it is being provided for external use as a public service. This agency accepts no responsibility for errors or omissions contained in this data. The accuracy of this data is therefore not guaranteed, and prudent surveyors or mariners should not rely solely upon it.

Point_of_Contact:

Contact_Information:

Contact_Person_Primary:

Contact_Person: Mark W. Huber

Contact_Address:

Address_Type: mailing address

Address:

U.S. Army Corps of Engineers
New Orleans District
Survey Section
CEMVN-ED-SS
P.O. Box 60267

City: New Orleans

State_or_Province: LA

Postal_Code: 70160-0267

Country: USA

Contact_Voice_Telephone: (504) 862-1852

Contact_Facsimile_Telephone: (504) 862-1850

Contact_Electronic_Mail_Address: mark.w.huber@MVN02.usace.army.mil

Data_Quality_Information:

Logical_Consistency_Report:

The quality of data collected is consistent between dates and vessels collection information.

Completeness_Report:

The listed surveys represent complete collection for this date.

Positional_Accuracy:

Horizontal_Positional_Accuracy:

Horizontal_Positional_Accuracy_Report:

Hydrographic Survey Data collected via DGPS and
XY accuracy is +/- 3 feet.

Topographic Data is Third Order Class II

Lineage:

Source_Information

Source_Citation:

Citation_Information:

Originator: New Orleans District.
Publication_Date: Unpublished material
Title: No title, data not formally published,
hard copy is avail
Geospatial_Data_Presentation_Form: ASCII File
Publication_Information:
Publication_Place: n/a
Publisher: n/a
Other_Citation_Details: n/a

Type_of_Source_Media: paper

Source_Time_Period_of_Content:

Time_Period_Information:

Single_Date/Time:

Calendar_Date: JANUARY 6, 7, 15 and 16, 2004

Source_Currentness_Reference: ground condition

Source_Citation_Abbreviation:

Not avail.

Source_Contribution:

Not avail.

Process_Step:

Process_Description:

Hydrosurveys are collected via DGPS. Topographic
surveys are typically collected with total stations.

Source_Used_Citation_Abbreviation: N/A

Source_Used_Citation_Abbreviation: N/A

Process_Date: JANUARY 6, 7, 15 and 16, 2004

Source_Produced_Citation_Abbreviation:

N/A

Process_Contact:

Contact_Information:

Contact_Person_Primary:

Contact_Person: Ronald W. King

Contact_Address:

Address_Type: mailing address

Address:

U.S. Army Corps of Engineers
New Orleans District
Survey Section
CEMVN-ED-SS
P.O. Box 60267

City: New Orleans

State_or_Province: LA

Postal_Code: 70160-0267

Country: USA

Contact_Voice_Telephone: (504) 862-1853

Contact_Facsimile_Telephone: (504) 862-1850

Contact_Electronic_Mail_Address:

ronald.w.king@MVN02.usace.army.mil

Spatial_Data_Organization_Information:

Indirect_Spatial_Reference:

Filename: 04024LRP.em

This survey data is presented in an ASCII XYZ coordinate file.

Direct_Spatial_Reference_Method: Vector

Spatial_Reference_Information:

Horizontal_Coordinate_System_Definition:

State Plane:

Zone: 1702

Unit_of_Measure: USFEET

Entity_and_Attribute_Information:

Overview_Description:

Entity_and_Attribute_Overview:

The data attributes consist of soundings, depth curves (soundings), and obstructions.

Entity_and_Attribute_Detail_Citation:

not req'd.

Distribution_Information:

Distributor:

Contact_Information:

Contact_Person_Primary:

Contact_Person: Ronald W. King

Contact_Address:

Address_Type: mailing address

Address:

U.S. Army Corps of Engineers

New Orleans District

Survey Section

CEMVN-ED-SS

P.O. Box 60267

City: New Orleans

State_or_Province: LA

Postal_Code: 70160-0267

Country: USA

Contact_Voice_Telephone: (504) 862-1853

Contact_Facsimile_Telephone: (504) 862-1850

Contact_Electronic_Mail_Address: ronald.w.king@MVN02.usace.army.mil

Resource_Description: not applicable

Distribution_Liability:

The Government furnishes this data and the recipient accepts and uses it with the express understanding that the United States Government makes no warranties, expressed, or implied, concerning the accuracy, completeness, reliability, usability, or suitability for any particular purpose of the information and data furnished. The United States shall be under no liability whatsoever to any person by reason of any use made thereof. This data belongs to the Government. Therefore, the recipient further agrees not to represent this data to anyone as other than Government provided data. The recipient may not transfer this data to others without also transferring this disclaimer.

Standard_Order_Process:

Digital_Form:

Digital_Transfer_Information:

Format_Name: EM

Format_Information_Content: ASCII XYZ Format

Transfer_Size: 0.500 megabytes

Digital_Transfer_Option:

Online_Option:
 Computer_Contact_Information:
 Network_Address:
 Network_Resource_Name:
 <NONE>
 Online_Computer_and_Operating_System:
 Windows NT Server running Netscape WWW Server
Offline_Option:
 Offline_Media: 3.5 inch diskette
 Recording_Format: DOS for diskette
Fees: Labor and media fees will be charged for requests for off-line data

Metadata_Reference_Information:

Metadata_Date: JANUARY 6, 7, 15 and 16, 2004

Metadata_Contact:

 Contact_Information:

 Contact_Person_Primary:

 Contact_Person: Mark W. Huber

 Contact_Address:

 Address_Type: mailing address

 Address:

 U.S. Army Corps of Engineers

 New Orleans District

 Survey Section

 CEMVN-ED-SS

 P.O. Box 60267

 City: New Orleans

 State_or_Province: LA

 Postal_Code: 70160-0267

 Country: USA

 Contact_Voice_Telephone: (504) 862-1852

 Contact_Facsimile_Telephone: (504) 862-1850

 Contact_Electronic_Mail_Address: mark.w.huber@MVN02.usace.army.mil

Metadata_Standard_Name:

 FGDC Content Standards for Digital Geospatial Metadata

Metadata_Standard_Version: 19940608

12-9. Sample Submittal of Feature Data Accuracy

Some software will provide estimated accuracies of located features. These accuracies are usually based on a priori estimates, unless connected (redundant) adjustment statistics are available. Figure 12-10 below depicts a topographic survey with estimated feature accuracies indicated by error ellipses.

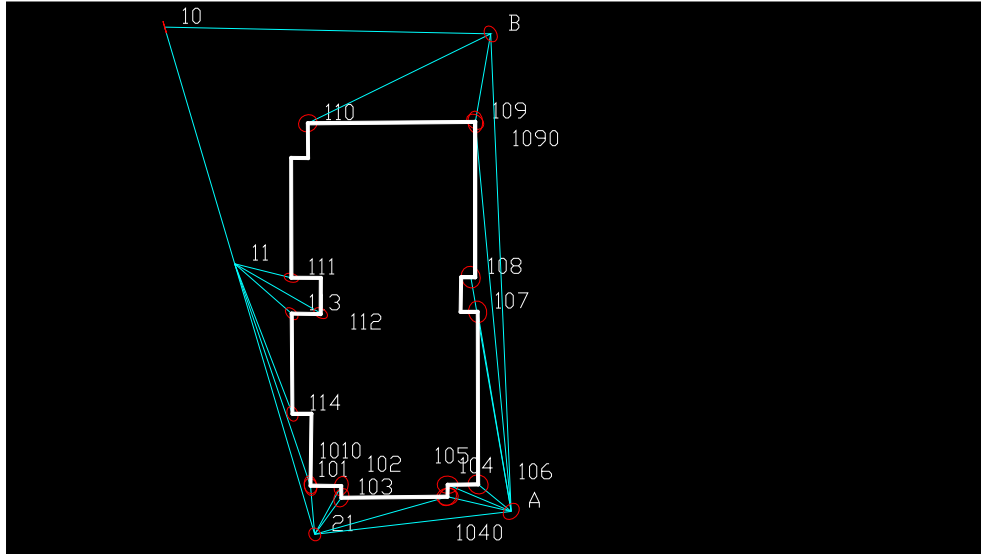

Figure 12-10. Error ellipses indicating horizontal feature accuracy on shots to building corners. Error estimates are relative to closed traverse from Point “10” which was constrained. Errors logically increase with distance from Point “10.”

12-10. Deliverable QA Checklist

The following list may be used for verifying receipt of deliverables and as a QA check on submitted data.

- GPS network sketch
- Control diagram
- GPS raw data along with field observation log sheets filled out in field with all information and sketches
 - Traverse sketches
 - Level line sketches
 - Raw data and computation files with horizontal and vertical abstracts
 - GPS baseline reduction reports
 - Traverse adjustments
 - Level line adjustments
 - Free and constrained adjustment reports (combined observations)
 - Field survey books (original) containing daily record of survey observations
 - Scanned field survey books (in Adobe Acrobat PDF format, one field book per file)
 - Detail sketches of utilities and other planimetric features
 - ASCII file containing all reduced coordinate data in X-Y-Z format
 - DGN, DTM, and ESRI files
 - Advance hard-copy plots (2 sets)
 - Metadata files (*.gen and *.met files)
 - Final Survey Report (narrative format following outline earlier in this chapter)

12-11. Mandatory Criteria

Preparation and submittal of metadata, as described in paragraph 12-10, is mandatory.

Chapter 13 Topographic Survey Contracting and Cost Estimating

13-1. General Contracting Policies and Procedures

The following sections describe the process for contracting topographic and control surveying services, including related cost estimates. It covers development of survey scopes of work, performance specifications, and cost estimates for Architect-Engineer (A-E) contracts. Although this chapter is intended to provide guidance for estimating costs for surveying services, the explanations herein regarding procurement policies and practices describe only the framework within which cost estimates are used. For detailed guidance on procurement policies and practices, refer to the appropriate procurement regulations: FAR, DFARS, AFARS, EFARS, EP 715-1-7 (*Architect-Engineer Contracting*), and the PROSPECT course specific to A-E contracting.

a. Brooks Architect-Engineer Act. In the Federal government, professional architectural, engineering, planning, and related surveying services must be procured under the Brooks Architect-Engineer Act, Public Law 92-582 (10 US Code 541-544). The Brooks A-E Act requires the public announcement of requirements for surveying services, and selection of the most highly qualified firms based on demonstrated competence and professional qualifications. Cost or pricing is not considered during the selection process. After selection, negotiation of fair and reasonable contract rates for the work is conducted with the highest qualified firm. Topographic surveying supporting the Corps' research, planning, development, design, construction, or alteration of real property is considered to be a related or supporting architectural or engineering service, and must therefore be procured using Brooks A-E Act qualifications-based selection, and not by bid price competition.

b. Contracting processes and procedures. Corps procedures for obtaining A-E services are based on a variety of Federal and DOD acquisition regulations. The following paragraphs synopses the overall A-E process used in the Corps.

(1) Types of contracts. Two types of A-E contracts are principally used for surveying services: Firm-Fixed-Price (FFP) contracts and Indefinite Delivery contracts (IDC). FFP contracts are used for moderate to large mapping projects (e.g., > \$1 million) where the scope of work is known prior to advertisement and can be accurately defined during negotiations--typically for a large new project site. Due to variable and changing engineering and construction schedules (and funding), most mapping work involving surveying services cannot be accurately defined in advance; thus, these fixed-scope FFP contracts are rarely used, and well over 95% of surveying services are procured using IDC.

(2) Announcements for surveying services. Requirements for surveying services are publicly announced and firms are given at least 30 days to respond to the announcement. The public announcement contains a brief description of the project, the scope of the required services, the selection criteria in order of importance, submission instructions, and a point-of-contact. This public announcement is not a request for price proposal, and firms are directed not to submit any price-related information.

(3) Selection criteria. Federal and DOD regulations set the criteria for evaluating prospective surveying contractors as listed below. These criteria are listed in the public announcement in their order of importance. (The order listed below may be modified based on specific project requirements.)

- Specialized experience and technical competence in the type of work required.

- Professional qualifications necessary for satisfactory performance.
- Past performance on contracts with Government agencies and private industry in terms of cost control, quality of work, and compliance with performance schedules.
- Capacity to perform the work in the required time.
- Knowledge of the locality of the project.
- Utilization of small or disadvantaged businesses.
- Geographic proximity.
- Volume of DOD contract awards.

[Note: the last three items are secondary selection criteria--see EP 715-1-7 (*Architect-Engineer Contracting*) for latest policy on A-E selection procedures and evaluation criteria]

(4) Selection process. The evaluation of firms is conducted by a formally constituted Selection Board in the Corps district seeking the services. This board is made up of highly qualified professional employees having experience in architecture, engineering, surveying, etc. The board evaluates each of the firm's qualifications based on the advertised selection criteria and develops a list of the three most highly qualified firms for a single award (multiple awards have slightly different requirements). As part of the evaluation process, the board conducts interviews with these top firms prior to ranking them. The firms are asked questions about their experience, capabilities, organization, equipment, quality management procedures, and approach to the project. These interviews are normally conducted by telephone. The top three firms are ranked and the selection is approved by the designated selection authority. The top ranked firm is notified they are under consideration for the contract. Unsuccessful firms are also notified, and are afforded a debriefing as to why they were not selected, if they so request.

(5) Negotiations and award. The highest qualified firm ranked by the selection board is provided with a detailed scope of work (SOW) for the project, project information, and other related technical criteria, and is requested to submit a price proposal for performing the work. A guide specification for developing the basic contract SOW is at Appendix D (*Sample Scopes of Work and Guide Specifications for Topographic Surveying Services*). In the case of IDC, price proposals consist simply of unit rates for various disciplines, services, and equipment. This list becomes the contract "Schedule" of prices, and the schedule will also include provisions for overhead, profit, and incidental supplies. Once a fair and reasonable price (to the government) is negotiated, the contract is awarded. The Government Contracting Officer is obligated to strive to obtain a negotiated price that is "fair and reasonable" to both the Government and the contractor.

c. Survey personnel requirements and qualifications. The general personnel requirements that would be found on a topographic or control survey services contract are as follows:

- Contractor's Project Manager (PM). PMs shall be thoroughly familiar with all phases of surveys and their relationship to the design, construction, and development of major engineering projects, in addition to the contract supervision and administration aspects related thereto. As PM, this official shall exercise the full managerial control required to efficiently, economically, and technically administer all contract forces assigned to perform work under the contract.

- Professional Land Surveyor. Professional surveyors shall be thoroughly familiar with all phases of surveying as it pertains to control traverses, and establishing and reestablishing of property and/or boundary lines. They shall be qualified to perform supervisory and administrative duties in connection with economical and efficient operation; planning the work and making assignments; and in performing any other duties necessary for accomplishment of assigned work. Proof of registration will be furnished upon request. Land surveyors shall be licensed in the State where the work is performed. (Since many

topographic surveys involve ties to property corners, this work should be done under the supervision of a Professional Land Surveyor).

- Supervisory Surveying Technician (Party Chief). The Party Chief shall be thoroughly familiar with all phases of surveys for design and construction projects. These surveys will include design data, horizontal and vertical control surveys, geodetic surveys, cadastral, topographic and construction layout, profiles, cross sections, quantity, and measurement surveys. They shall also be qualified to make field computations for accomplishment of work assigned. Each field Party Chief shall be capable of planning the work for his party to obtain work efficiency and to gainfully utilize all of the members of his party.
- Survey Technician (Instrumentperson/Recorder). Instrumentperson/Recorders shall be capable of operating under supervision, survey instruments, including theodolite, transit, level, alidade, and electronic distance meters. They shall be experienced in keeping all forms of notes in a firm and legible hand, and operating data collectors.
- Survey Technician (Rodperson/Chainperson). Rodpersons/Chainpersons shall be assigned to perform a limited variety of simple repetitive tasks, such as but not limited to, holding rod or range pole for observation and measuring distances by steel tape.
- Engineering Technician (Drafter/Mapper/CADD Operator). A drafter shall be capable of preparing neat and legible drawings of topographic and property surveys; they shall have substantial experience in the drafting field including proficiency with CADD and be capable of performing assignments of originality or complexity. They shall be capable of applying initiative and resourcefulness in independent planning of methods.
- Civil Engineering Technician (Office Survey Computer). The survey Computer Person shall be capable of making all computations and adjustments required for all surveying, mapping, and geodesy requirements performed under the contract. The Computer Person shall have had extensive field experience in addition to a comprehensive mathematical computing ability. The Computer Person shall be designated with the authority to recommend re-observations when the data does not meet the accuracy specifications required under the contract. The Computer Person shall be thoroughly familiar with all computational techniques and procedures covered under the referenced technical specifications, e.g., COGO, GPS baseline reduction, network adjustments, coordinate transformations, etc.

13-2. Indefinite Delivery Contracts

The vast majority of the Corps surveying services are procured using Indefinite Delivery Contracts (IDC). These IDCs are procured using the selection and negotiation process described above. IDC (once termed "Open-End" or "Delivery Order" contracts) have only a general scope of work--e.g., "Topographic Surveying Services in Southeastern United States." When work arises during the term of the contract, task orders are written for performing that specific work. Task orders are negotiated using the unit rate "Schedule" developed for the main contract. Thus, negotiations are focused on the level of effort and performance period. Task orders typically have short scopes of work--a few pages. The scope is sent to a contractor who responds with a proposal incorporating the scheduled rates, from which negotiations are initiated. Under emergency conditions (e.g., flood fights, hurricanes) contractors can be issued task orders verbally by the Contracting Officer, with the scope of work simply defined as a limiting number of days for survey crew at the contract schedule rate. The entire process--from survey need to task order award--should routinely take only 2 to 4 weeks. From the IDC Schedule, a survey crew and equipment is pieced together using the various line items--adding or deducting personnel or equipment as needed for a particular project.

a. *Unit price basis.* A number of methods are used by Districts for estimating and scheduling topographic surveying services in a fixed-price or IDC contract. The most common method is a “daily rate” basis, although hourly rates for personnel labor are used by some Districts. A daily rate basis is the cost for personnel or equipment over a nominal 8-hour day. In some cases, a composite daily rate may be estimated and negotiated for a full field crew (including all personnel, instrumentation, transport, travel, and overhead). A daily (or hourly) crew rate is the preferred unit price basis for estimating contracted survey services for IDC contracts and their task orders. It provides the most flexibility for IDC contracts, especially when individual project scopes are expected to vary widely. The crew personnel size, total stations, RTK systems deployed, vehicles, etc., must be explicitly indicated in the contract specifications, with differences resolved during negotiations. Options to add additional personnel and/or transport must be accounted for in the estimate and unit price schedule. Cost estimates for surveying services are usually broken down using the following detailed analysis method.

Table 13-1. Factors for Estimating A-E Costs

Item	Description
I	Direct labor or salary costs of survey technicians: includes applicable overtime or other differentials necessitated by the observing schedule
II	Overhead on Direct Labor *
III	G&A Overhead Costs (on Direct Labor) *
IV	Direct Material and Supply Costs
V	Travel and Transportation Costs: crew travel, per diem, airfare, mileage, tolls, etc. Includes all associated costs of vehicles used to transport personnel & equipment
VI	Other Direct Costs (not included in G&A): includes survey equipment and instrumentation, such as total stations. Instrument costs should be amortized down to a daily rate, based on average utilization rates, expected life, etc. Some of these costs may have been included under G&A. Exclude all instrumentation and plant costs covered under G&A, such as interest
VII	Profit on all of the above (Computed/ negotiated on individual task order or developed for all task orders in contract)

* these may be combined into a single overhead rate

b. *Contract Price Schedule.* The various personnel, plant and equipment cost items like those shown in Table 13-1 above are used as a basis for negotiating fees for individual line items in the basic IDC contract. During negotiations with the A-E contractor, individual components of the contractor's price proposal may be compared and discussed. Differences will be resolved in order to arrive at a fair and reasonable price for each line item. The contract may also schedule unit prices based on variable crew sizes and/or equipment. A typical negotiated IDC price schedule (Section B - Supplies or Services and Prices/Costs) is shown below in Table 13-2. The contract specifications would contain the personnel and equipment requirements for each line item. Each Corps district has its unique requirements and therefore line items used in schedules will vary considerably. For instance, some districts may elect to apply overhead as a separate line item. Others may compute profit separately for each task order and others may not include travel costs with crew rates. The following sample price schedule included 150% overhead on the labor rates. Profit is assumed to be a separate (but constant) line item (10.5%) that will be added to each Task Order.

(Technically, a formal IGE is not prepared for a basic Indefinite Delivery Contract since there is no scope of work; however, the same IGE preparation principles are used in estimating line items in an IDC schedule. An informal IGE can be prepared for Task Orders less than \$100,000. An IGE for a Task Order will be prepared using the contract rates for labor, overhead, supplies, travel, etc.).

Table 13-2. Sample Contract Schedule of Services for an Indefinite Delivery Contract used for Topographic Surveying Services

<u>LINE ITEM</u>	<u>UNITS</u>	<u>DAILY RATE</u>
SUPV PROF CIVIL ENGINEER	daily	\$795.60
SUPV PROF LAND SURVEYOR	daily	\$681.20
REGISTERED LAND SURVEYOR	daily	\$572.00
CIVIL ENGR TECH	daily	\$364.00
CARTOGRAPHIC TECH (Includes CADD WorkStation Operator)	daily	\$332.80
STEREO PLOTTER OPERATOR (Includes Photogrammetric Softcopy WorkStation)	daily	\$455.52
ENGINEERING/CARTOGRAPHIC AID	daily	\$309.92
G.I.S. SYSTEMS ANALYST (Includes CADD WorkStation)	daily	\$582.40
G.I.S. DATABASE MANAGER (Includes CADD WorkStation)	daily	\$542.88
G.I.S. TECHNICIAN (Includes CADD WorkStation)	daily	\$343.20
PARTY CHIEF	daily	\$384.80
PARTY CHIEF (OVERTIME)	hour	\$28.86
INSTRUMENTPERSON	daily	\$291.20
RODMAN-CHAINMAN-LABORER	daily	\$234.00
4-PERSON TOPOGRAPHIC SURVEY PARTY	daily	\$1,196.00
3-PERSON TOPOGRAPHIC SURVEY PARTY	daily	\$904.80
2-PERSON TOPOGRAPHIC SURVEY PARTY	daily	\$665.60
1-PERSON TOPOGRAPHIC SURVEY PARTY	daily	\$502.98
MOB & DEMOB OF SURVEY PARTY	per project	\$988.00
TOTAL STATION EQUIPMENT COST cost per instrument & data collector, per day	daily	\$50.00
GPS EQUIPMENT COST cost per receiver, per day	daily	\$75.00
FIELD COMPUTING PCS & SOFTWARE	daily	\$50.00
MISC. ITEMS		
ATV	daily	\$104.00
Milage-4 Wheel Truck	per mile	\$0.60
SMALL SURVEY SKIFF BASIC RATE	daily	\$93.60
W/Fathometer	daily	\$107.12
Materials (PVC, steel fence posts, rebar, misc.)	daily	\$10.00
PER DIEM (estimate actual costs on each Task Order--use JTR per diem rates)	daily	
PROFIT (use 10.5% for all task orders issued under contract)		

c. Personnel and crew line items. Individual line items in the above schedule need to be explicitly defined in the IDC specifications. For example, the specifications must define what instrumentation and plant, if any, is included on a “2-PERSON SURVEY PARTY.”

d. Overtime rates. Overtime rates should rarely be used--generally only during emergency operations. Task Orders issued under an IDC will be estimated based on nominal 40-hour weeks (8-hour or 10-hour workdays). Options to work overtime are the prerogative of the A-E contractor--it is not the Government's mission to tell a contractor how to schedule his forces. Overtime rates do not include overhead. Thus, in the above example, the \$28.86 overtime rate for the "Party Chief" is based on 1.5 times a base hourly rate of \$19.24. The daily rate of \$384.80 is determined from \$19.24/hr x 8 hr/day x 150% overhead rate.

e. Mob/Demob. This sample schedule shows a fixed mob/demob rate, which is used by some Districts. This is a carryover from traditional construction contracting where mob/demob is a bid line item. Generally, surveying services would not use a constant mob/demob rate as shown here--mainly because under an IDC the job location for the Task Orders is normally unknown. Mob/demob times would be applied to the time estimates for personnel and equipment in individual Task Orders. (There might be cases where the work site is the same installation for the entire contract period--then a fixed mob/demob rate would be applicable).

f. Excessive mob/demob costs. In the above sample schedule, the mob/demob rate of \$988.00 exceeds the \$665.60 daily rate for a 2-man survey crew. If a Task Order issued under this contract entails only one day of effort, then this not a cost effective contract for surveying services. An alternate A-E procurement mechanism should be used for a small amount of work--e.g., credit card issuance to a firm located near to the job site.

g. Miscellaneous items in Schedule. Generally, it is preferred to lump miscellaneous supplies into a crew rate or include it in overhead. The \$10.00 line item in the above Schedule for "Materials" could have been included in the contract overhead. If there is a major requirement for supplies on a Task order, then this can be negotiated during the order--e.g., "200 monuments with bronze discs." The fewer the number of line items in the contract schedule, the easier it is to estimate individual task orders.

13-3. Cost Estimates for Contracted Topographic Mapping IDCs

Cost estimates are required for each line item in an IDC schedule. These estimates must be sufficiently detailed such that the Government negotiator can reach a "fair and reasonable" price with the selected A-E firm. Details on performing government cost estimates for A-E contracts are covered in EP 715-1-7 and the PROSPECT course "A-E Contracting." The following cost computations are representative of the procedures used in preparing the IGE for an A-E contract and/or an IDC contract price schedule. Costs and overhead percentages are shown for illustration only--they are subject to considerable geographic-, project-, and contractor-dependent variation (e.g., audited G&A rates could range from 50 to 200 percent).

a. Labor. Labor rates are direct costs and are estimated for each personnel line item required in the basic IDC contract. The estimated labor rate is obtained from a number of sources, such as:

- Prior contract rates
- Trade publications
- Equivalent GS rates
- Department of Labor published rates (including Service Contract Act minimum rates)
- Labor rates in other District IDCs

b. Indirect overhead costs. Overhead is an indirect cost--a cost that cannot be directly identified with the performance of a contract but is necessary for the normal operation of a business. Overhead is

normally broken into two parts: Direct and General & Administrative (G&A). Direct overhead includes items such as benefits, health plans, retirement plans, life insurance, etc. G&A includes office supervision staff, marketing, training, depreciation, taxes, insurance, utilities, communications, accounting, downtime, etc. (Care must be taken to ensure there is no duplication between G&A overhead and direct costs. An example of duplication might be a maintenance contract for a total station being included in both G&A and directly on the equipment cost). Usually direct and G&A overheads are combined into one amount and applied as a percentage against the base labor cost. Overhead rates are estimated using similar resources listed above for labor rates. Arbitrary limits on overhead rates should never be set. Overhead rates are negotiable and may optionally be audited before contract award.

The following is a sample IGE labor rate computation for two selected line items in a schedule: a party Chief and a Survey Aid. (2,087 hours per year assumed). Direct and G&A overheads are broken out for the Party Chief but are shown combined for the Survey Aid. A daily rate, hourly rate, and overtime rate is shown.

SAMPLE IGE LABOR RATE COMPUTATIONS

Supervisory Survey Tech (Party Chief)	\$42,776.00/yr	<i>(based on GS pay schedule)</i>
Overhead on Direct Labor (36%)	\$15,399.36/yr	<i>(based on historical rates)</i>
G&A Overhead (115%)	<u>\$49,192.40/yr</u>	<i>(based on historical rates)</i>
Total:	\$107,367.76/yr or \$411.57/day or \$51.44/hr	
	[Overtime rate: \$42,776 / 2087 x 1.5 = \$30.74]	
Survey Aid	\$23,332/yr	<i>(based on GS pay schedule)</i>
@ 151 % O/H (36%+115%)	\$58,563.32/yr or \$224.49/day or \$28.06/hr	
	[Overtime rate: \$23,332 / 2087 x 1.5 = \$ 16.77]	

c. Estimating equipment and instrumentation costs. The following is an example of instrumentation cost estimates in an IGE. Total station and RTK instrumentation rates used are approximate (2004) costs. The monthly “rental rates” are approximate long-term purchase agreement payments--daily cost must factor in estimated chargeable utilization each month--this can vary greatly. Associated costs for instrumentation, such as insurance, maintenance contracts, interest, etc., are presumed to be indirectly factored into a firm's G&A overhead account. If not, then such costs must be directly added to the basic equipment depreciation rates. Other equally acceptable accounting methods for developing daily costs of equipment may be used. Equipment utilization estimates in an IGE may be subsequently revised (during negotiations) based on actual rates as determined from a detailed cost analysis and field price support audits. The major variables in estimating costs are:

- Utilization rates. A particular survey instrument may be used (charged) only a limited number of days in a year. A total station or vehicle may be utilized well over 200 days a year whereas other instruments are not used on every project. For example, a \$150,000 terrestrial scanner may be actually used only 20 days a year. If the annual operating cost of this instrument (without operator) is say \$40,000, then the daily rate is \$2,000/day. This is the amount that the contractor must charge to recoup his purchase or lease expenses (not including profit). A two-man survey crew may carry both a total station and RTK system with them in the field. Even though only one of these systems can be used on a

given day, both systems are chargeable for utilization. Utilization rates are difficult to estimate given they can vary widely from contractor to contractor, and with the type of equipment. Thus, the government estimator must have some knowledge of equipment utilization by a typical survey firm.

- Equipment cost basis. There are a number of methods to estimate the cost basis of a particular instrument. Trade publications (e.g., *POB*, *Professional Surveyor*, and *American Surveyor*) contain tabulations and advertisements with purchase costs, loan costs, rental costs, or lease costs. If an item is purchased, then an estimated life must be established--usually varying between 3 to 7 years for most electronic equipment and computers. Assuming the instrument is purchased on a loan basis, the annual/monthly cost can be estimated--e.g., a \$40,000 instrument purchased over 5 years at 5% is \$755/month. At 15 days/month estimated utilization, the daily rate would be \$50/day. Lease rates published in trade publication also provide estimates for costs. Rental rates are applicable to obtaining IGE estimates. In general, rental rates will run between 5% and 15% of the original purchase cost, per month. Thus, a \$40,000 instrument could be rented for \$4,000 per month, assuming a 10% rate. If it is utilized 15 days a month, then the daily rental rate would be \$266/day. Obviously, in the above examples, rental rates far exceed purchase rates. The IDC contract solicitation should have specified the desirability for ownership versus rental of instruments and equipment.

The following are selected example computations of equipment costs rates that would be used in preparing an IGE for an indefinite delivery contract schedule. The daily costs can be computed based on purchase (loan) costs or lease costs. A rental rate is another option.

ESTIMATING SURVEY INSTRUMENTATION & EQUIPMENT COSTS

Total Station: data collector, prisms, etc.		
\$32,000 purchase cost @ 5 yrs life @ 120 d/yr utilization		\$ 53/day
<i>At a typical lease rate of \$600/mo and 10 days utilization/mo</i>		<i>\$60/day</i>
RTK topographic system --2 geodetic quality GPS receivers, batteries, tripods, data collectors, etc.		
\$30,000 purchase cost @ 4 yrs @ 100 d/yr		\$ 75/day
Laptop, field--with COGO, GPS, and CADD software		
\$15,000 purchase cost @ 3 yrs @ 200 d/yr		\$ 25/day
Survey Vehicle \$50,000 @ 4 yrs @ 225 d/yr	\$ 55/day	
plus O&M, fuel, etc.	\$ 25/day	\$ 80/day

(A purchase or lease rate may be used. Optionally, a daily rental rate. The contract may be structured to pay actual mileage rates (e.g., \$0.50/mile). Vehicle costs should not include those items covered under G&A, such as liability insurance, etc.)

Misc Materials (field books, survey supplies, etc)	\$ 15/day
--	-----------

d. Travel and per diem. Travel and per diem costs are usually negotiated on individual task orders, based on the geographical location, transport vehicles (air, land, or floating plant), mob/demob times, etc. Maximum per diem is based on current JTR/GSA rates.

e. Material costs. The material cost estimate above could have been easily included in G&A overhead, given these are usually small amounts relative to the other labor and equipment line items. Unusual material costs on an individual Task Order can be negotiated as a lump sum item on the order-- e.g., custom monuments.

f. Combined Crew Rates. The labor and equipment line items described above can be combined to obtain a single rate for a one or two man topographic crew. For example, a one-man crew would include a Party Chief, total station, computer, vehicle, and miscellaneous supplies. Using the above rates the daily cost of a one-man crew would be computed as follows:

Supervisory Survey Tech (Party Chief) [includes 151% O/H]	\$411.57/day
Total Station (robotic): data collector, prisms, etc.	\$53.00/day
Vehicle	\$80.00/day
Miscellaneous expenses	\$15.00/day
Subtotal	\$559.57/day
Profit at 10%	\$55.96/day
Total Crew Rate	\$615.53/day

[Travel and per diem expenses would be added separately on a task Order]

g. Verification of Contractor Cost or Pricing. Regardless of the contract price method used, it is essential (but not always required) that a cost analysis and price analysis be employed to verify all cost or pricing data submitted by a contractor, particularly major cost items such as equipment and plant. Some operation and maintenance costs may be directly charged, or portions may be indirectly included in a firm's G&A overhead account. In some instances, a firm may lease/rent survey instrumentation or plant equipment in lieu of purchase. Rental would be economically justified only on limited scope projects and if the equipment is deployed on a full time basis. Whether the equipment is rented or purchased, the primary (and most variable) factor is the equipment's actual utilization rate, or number of actual billing days to clients over a year. Only a detailed audit and cost analysis can establish such rates and justify modifications to the usually rough assumptions used in the IGE. In addition, an audit will establish any nonproductive labor/costs, which are transferred to a contractor's G&A. Given the variable equipment costs and utilization rates in surveying (particularly in specialized instrumentation such terrestrial lasers), failure to perform a detailed cost analysis and field pricing support audit on contracted surveying services will make the IGE difficult to substantiate.

13-4. Task Order Time and Cost Estimates

Once unit prices have been negotiated and established in the basic IDC schedule as illustrated in the above sections, each IDC task order is negotiated primarily for effort. The process for estimating the time to perform any particular survey function in a given project is highly dependent on the knowledge and personal field experience of the government and contractor estimators. The negotiated fee on a task order is then a straight mathematical procedure of multiplying the agreed-upon effort against the established unit prices in Schedule B, plus an allowance for profit if not included in the unit rates. A formal IGE is currently (2005) only required for task orders over \$100,000, along with a detailed profit computation, documented records of negotiations, etc. The scope is attached to a DD 1155 order placed against the basic contract. If a preliminary site investigation is scheduled for this project, any such adjustments should be investigated and resolved prior to negotiating subsequent task orders for the various phases of the work, to the maximum extent possible. As such, the negotiated costs for the subsequent work phases

would be considered fixed price agreements. Any later adjustments to these agreed to prices would be issued in the form of modifications to task orders (change orders), and would have to be rigorously defended as significant, unforeseen changes in the scope. The contractor would be expected to immediately notify the contracting officer (KO) or Contracting Officer's Representative (COR) of the need for cost adjustments. The following process (excerpted from Louisville District) is representative of the steps taken to initiate a Task Order in a District. Note that these procedures will vary from District to District.

- Request for survey/mapping information. Make sure proposed work is within the scope of services in the basic Indefinite Delivery contract. You may need to use another contract available through others in your district. You may also request contract capacity from another district. If you have in-house capability you may also propose to do this work using government resources. The schedule of the work request may also determine how you proceed. The contracting process takes time (up to 2 to 4 weeks or more) and in-house forces may be more readily available for projects requiring quick turn around.

- Develop Scope of Work (SOW). Request funding for your labor to develop SOW. You may develop the SOW with the help of your co-workers and you may also ask project related questions of the contractor. You may not discuss cost with the contractor at this time. Include a description of the work required, a schedule, quality control, and safety plan (if required). You may also reference the required engineering manuals which are available on-line.

- Review SOW with project manager (PM) and make necessary changes.

- Develop Independent Government Estimate (IGE) or Informal Working Estimate for small orders. Determine if original SOW matches project budget and verify availability of funds. If original request exceeds available budget, offer cost saving alternatives; e.g., aerial photography flown at a higher altitude or less detailed mapping and contours etc.

- Get money set up and moved in appropriate funding systems (P2/CEFMS) so you may create a Purchase Request & Commitment (PR&C).

- Get a labor code set up for Contracting personnel to process PR&C.

- Write labor PR&C.

- Write request for proposal (RFP) letter.

- Get PR&C reviewed and approved. Notify contracting office that the labor PR&C has been written and forward the SOW, IGE, and RFP. The contracting office will send RFP and SOW to the contractor. The contractor will normally have 10 days to submit their proposal. When contracting receives the proposal they will forward it to you for technical analysis. If the proposal is acceptable notify contracting and they will award the task order and send the notice to proceed to the contractor. If the proposal is not acceptable, identify items that are out of compliance and forward a list of these items to contracting as points of negotiation. Contracting will schedule a negotiation date. During the negotiation you will discuss the points of negotiation and come to an acceptable compromise with the contractor. You may need to modify your SOW and IGE based on the negotiations. Forward the updated contract documents and contracting will award the task order and send the notice to proceed.

13-5. Task Order Request for Proposal

Following is an example of a letter request for proposal for topographic surveying services. This proposed task order from Louisville District supports topographic and boundary surveys of a US Army Reserve Center. The Scope of Work (SOW) attachment to this letter is included here. Sample SOWs for other military and civil works topographic mapping surveys are provided at Appendix D in the other Application Project appendices to this manual.

SAMPLE LETTER REQUEST FOR PROPOSAL

26 March 2002

Survey and Mapping Section

EarthData International
45 West Watkins Mill Road
Gaithersburg, MD 20878

Gentlemen:

Reference is made to Indefinite Delivery Contract No. DACW27-00-D-0017 for survey and mapping services for the Louisville District Corps of Engineers.

Enclosed is a scope of work dated 25 March 2002 for topographic mapping and boundary survey of a proposed USARC site in the vicinity of Cleveland, OH. This work is for a delivery order under the above-referenced contract. Please submit your proposal no later than ten (10) calendar days after receipt of this letter. Return your proposal by mail to the U.S. Army Corps of Engineers 600 Dr. Martin Luther King, Jr., Place, Room 821, Louisville, KY 40202-2230, or by fax to 502/ 315-6194. Mark your proposal to the ATTENTION OF **CELRL-CT (PR&C W22W9K 20949148)**.

The "Release of Claims" form should be submitted after completion of the project along with your Final Pay Estimate.

If you have contractual questions, please call Robin Woodruff at 502/ 315-6189. For technical questions concerning the scope of work contact Chris Heintz at 502-315-6408.

Sincerely,

Robin Woodruff
Contract Specialist

Enclosure

CF:
CELRL-ED-M-SM (C. Heintz)

EM 1110-1-1005
1 Jan 07

The following is the Scope of Work that was attached to the above letter request for proposal:

SCOPE OF WORK
Contract No. DACW27-00-D-0017
EarthData, International

Date: 25 March 2002

Project: United States Army Reserve Center-Boston Heights, OH

GENERAL

The contractor, operating as an independent contractor and not as an agent of the government, shall provide all labor, material, and equipment necessary to perform professional surveying & mapping for the Louisville District Corps of Engineers. The work required consists of gathering field data, compiling this data into a three-dimensional digital topographic map of the proposed site for a United States Army Reserve Center in the vicinity of Boston Heights, OH.

This project also requires performing a boundary survey of the site. The details of the boundary survey are described in the attached scope of work.

The contractor shall furnish the required personnel, equipment, instrumentation, and transportation as necessary to accomplish the required services and furnish to the government digital terrain data, control data forms, office computations, reports, and other data with supporting material developed during the field data acquisition and compilation process. During the prosecution of the work, the contractor shall provide adequate professional supervision and quality control to assure the accuracy, quality, completeness, and progress of the work.

TECHNICAL CRITERIA AND STANDARDS

The following standards are referenced in specification and shall apply to this contract:

USACE EM 1110-1-1005, Topographic Surveying: This reference is attached to and made part of this contract. This reference is available at the following Internet Address <http://www.usace.army.mil/inet/usace-docs/eng-manuals/em1110-1-1005/toc.htm> and made part of this contract.

USACE EM 1110-1-1002, Survey Markers and Monumentation: This reference is available at the following Internet address <http://www.usace.army.mil/inet/usace-docs/eng-manuals/em1110-1-1002/toc.htm>.

Spatial Data Standards (SDS): This reference is available at the following Internet address <http://tsc.wes.army.mil/>.

ASPRS: American Society for Photogrammetry and Remote Sensing accuracy standards for large-scale maps. Digital Elevation Model Technologies and Applications: The DEM Users Manual.

SCOPE OF WORK

Professional surveying, mapping and related services to be performed under this contract are defined below. Unless otherwise indicated in this contract, each required service shall include field-to-finish effort. All mapping work will be performed using appropriate instrumentation and procedures to establishing control, field data acquisition, and compilation in accordance with the functional accuracy requirements to include all quality control associated with these functions. The work will be accomplished in accordance with surveying and mapping criteria contained in the technical references, except as modified or amplified herein.

The three-dimensional digital topographic map will be compiled in meters at a scale of 1:600, with ¼-meter (25 cm) contours. The mapping area is outlined on the attached map. All planimetric features will be shown. This includes, but is not limited to buildings, sidewalks, roadways, parking areas (including type such as gravel, paved, concrete, etc.), visible utilities, trees, road culverts (including type, size and inverts). Rim, ground surface and invert elevations and pipe sizes at sanitary manholes, cleanouts, storm manholes, inlets and catch basins, location of fire hydrants and water valves, location and type of fences and walls will be shown.

A referenced baseline with a minimum of two points will be established adjacent to each site. The location of the baseline will be set in an area that will not be disturbed. At least two benchmarks will be set within the map area. The baseline stations and benchmarks will be referenced and described. The Corps will supply survey disks on 30" aluminum rods and witness posts for the baselines. A spike in a pole, or chiseled square in a headwall, etc. will suffice for benchmarks. Real estate boundary monuments may be used as baseline monuments and TBMs. The descriptions of the baselines and benchmarks will be shown in the digital file on a separate level. In addition to showing the descriptions in the digital file, a hard copy of the descriptions will be submitted with the project report.

The coordinates of the mapping projects will be tied to the Ohio (North Zone) State Plane Coordinate System NAD83 and vertically tied to NAVD 1988.

PROJECT DELIVERABLES

The contractor will submit the final topographic map in digital format. The digital map will be submitted in MicroStation format, (*.dgn) on 3 ½" diskette or CD-ROM. The file will be created in MicroStation and not translated from other CADD software. The digital file will be created in 3-D with the topographic and planimetric elements placed at their actual X & Y coordinate locations. The global origin will be 0,0 and the working units will be 1000:1. The Louisville District Corps of Engineers CADD standards will be used. These standards contain the correct cell libraries, symbology and level assignments, colors, line weights, etc.

A project report will be compiled. This report will contain a general statement of the project, existing geodetic control used to establish new monumentation, condition of existing monuments, baseline and TBM descriptions and references, amount of adjustments, procedures and equipment used, all file names, any special features unique to this particular project, and personnel performing the surveying and mapping.

All field notes will be submitted in a standard bound survey field book or if electronic data collection methods were employed, all digital raw data files, in ASCII format will be submitted. If electronic data collection was the method of choice for capturing the information, the final X, Y & Z coordinate file, in ASCII format, will be submitted with the raw data file.

A metadata file describing the project. If necessary, the Government will supply Corpsmet software. Corpsmet is a program that puts metadata information into the proper format so it may be submitted to the national spatial data clearinghouse.

QUALITY CONTROL

A quality control plan will be developed and submitted. The quality control plan will describe activities taken to ensure the overall quality of the project.

The accuracy of the mapping will meet or exceed ASPRS map accuracy class 2.

Map verification will be performed at each site. The verification will be accomplished by collecting coordinates for 10 random points at each site and comparing them with the coordinates of the same points on the finished map. The random points will not be used to compile the finished map. Differences between the field-test information and the finished map will be compared with differences allowed by ASPRS map accuracy class 2 standards. Any areas found to be out of compliance must be corrected

EM 1110-1-1005
1 Jan 07

before submittal. A summary of the actual vs. allowable differences along with a statement that mapping meets ASPRS map accuracy class 2 standards will be provided with the data.

SAFETY

Every safety measure feasible will be taken to insure the safety of the field personnel involved in this survey. All requirements of the U.S. Army Corps of Engineers EM 385-1-1, titled SAFETY AND HEALTH REQUIREMENTS MANUAL will be maintained.

SCHEDULE

All work will be completed and submitted by 15 May 2002. All information developed by the contractor during the course of this work will be the property of the United States Government, acting through the U.S. Army Corps of Engineers, Louisville District. Such information will not be released to others without the express written permission of the Corps of Engineers.

13-6. Government Cost Estimate for a Task Order

The following is an example of a cost estimate prepared for a small (4 day) topographic surveying project in Tulsa District. A more formal IGE is not required; however, the format shown on this informal estimate would be similar to that followed for an IGE. Labor and overhead rates are taken from the price schedule in the basic IDC contract. The 12% profit was computed for this task order using a weighted guideline method described in the next paragraph.

**CONTRACT NO. DACW56-01-D-0000
TASK ORDER NO. 16
PAT MAYSE LAKE SCOUR AREA ALONG RIVER
TOPOGRAPHIC SURVEY
COST ESTIMATE
08JAN03**

1. ESTIMATED FIELD TIME

PERSONNEL IN FIELD CREW	2	Crew
RECON AND ACCESS TO SITE	0.5	DAYS
ACCOMPLISH REQUIRED SURVEY	2.5	DAYS
TRAVEL	<u>1</u>	DAYS
TOTAL DAYS	4	

2. DIRECT LABOR COSTS:

A).	Project Manager			
2	Hrs x Rate	\$26.00		\$52.00
B).	Project Field Supervisor			
32	Hrs x Rate	\$25.00		\$800.00
C).	Instrument Man			
32	Hrs x Rate	\$16.00		\$512.00
D).	Cad Technician			
20	Hrs x Rate	\$17.00		<u>\$340.00</u>

Total Direct Labor Costs **\$1,704.00**

3. OVERHEAD (Direct + G&A)

115.00% Direct Labor \$1,704.00 **\$1,959.60**

4. PROFIT (Direct Labor + Overhead)

12.00% of L + O.H. \$3,663.60 **\$439.63**

5. INDIRECT COSTS

A).	Survey Vehicle			
4	Days x Rate	\$120.00		\$480.00
B).	Per Diem			
4	Days x Rate x	\$103.00	2Men	\$824.00

Total In-Direct Cost----- **\$1,304.00**

6. TOTAL COST ESTIMATE----- **\$5,407.23**

The above time estimate allows 1 day for travel to/from the job site. This is paid at the crew rates instead of a separate mob/demob line item. The hourly rates from the basic IDC schedule do not include overheads--these are applied on the task order estimate as shown above. There is no separate estimate for survey instruments--this equipment is assumed to be included in the overhead. The 12% profit on this task order was computed and documented as shown on the following memorandum. Note that many Districts do not compute a profit for each task order as shown here. A profit is computed and negotiated when the initial IDC is set up. This constant profit will be used to cover the entire basic IDC--under the assumption that all the task orders that will be performed over the entire (3-year) contract period is of similar complexity, length, etc. Note also that profit was not computed on the "indirect costs" shown in the above Tulsa District cost estimate. Normally, profit is computed on the total estimated cost of a work order, including travel and transportation costs.

ALTERNATE STRUCTURED APPROACH CALCULATIONS
ARCHITECT-ENGINEER CONTRACTS
(Reference EFARS 15.404-73-101)

Project Description: Pat Mayse Lake Scour Erosion Area Topographic Survey

Project Schedule: The contractor is to commence with the project within one week (7 days) of award and final delivery made to the Government within 14 calendar days from date of award.

<u>Element</u>	<u>Range</u>	<u>Weight</u>		
Technical Complexity	0.05 - 0.10	0.090		
Length	0.02 - 0.04	0.030		
Socioeconomic Factors	0.00 - 0.02	0.000		
TOTAL		0.120	=	12.00%

For another example of a cost estimate on an IDC task order, see Appendix G (*Application: Topographic Survey of Hannibal Lock & Dam--Proposed Nationwide DGPS Antenna Site (Pittsburgh District)*).

13-7. A-E Services Request for Task Order Issuance

The following is an example of an internal action request to initiate contracting action to finalize the task order award. If the A-Es price proposal has been received, it would be attached to this memorandum along with the sample Technical Analysis memorandum shown below. Appropriate District elements responsible for negotiation and award would take action on this request.

ARCHITECT-ENGINEER SERVICES REQUEST

1. Negotiation and award of Architect-Engineer services is required for the following contract action:

Location: Pat Mayse Lake Scour Erosion Sanders Creek

Project: Topographic Survey

Contract Number: DACW56-01-D-0000

Task Order/Modification Number: 00-16

Architect-Engineer Firm: ***** Surveyors, Inc.

A-E Phone: (800) 123-4567 A-E Fax: (888) 123-4567

A-E Point of Contact (if known): ***** , PLS

2. The "DRAFT" Scope of Work is attached.
3. An appropriate Site History is attached.
4. The Approved Government Estimate is attached (~~or will be provided no later than~~_____).
5. The Project Execution Plan (PEP) Board Memorandum or waiver is attached for HTRW contract actions.
6. This contract action must be awarded absolutely no later than 24Jan03
for the following reason/s: _____
7. Purchase Request and Commitment Number _____ has been approved and certified for this action and is attached. It will be amended for the total award amount following negotiations.
8. The Estimated Construction Cost (if applicable) is \$_____.
9. The Project Manager is Marjorie Courtright, PLS at extension 7574.
10. Additional Remarks:

Project Engineer: Bob Goranson
Section: CESWT-EC-CD
Extension: (918) 669-7
Requesting Org: CESWT-EC-DD
Date: 08Jan03

NOTE: Attachments should be via printed and electronic copies.

**Pat Mayse Lake Scour Erosion Area Sanders Creek Topographic Survey
DACW56-01-D-1005
Task Order 16
Technical Analysis
Request for Proposal Results
14 Jan 03**

Please note the following concerning the above referenced:

The lump sum cost estimate provided by ***** Inc. was more than the Corps projected cost by \$ 96.32. This difference was a result of their firm estimating per diem time for the CADD Technician field crew time (this is acceptable since they considered no time for a Project Manager and less percent profit). The contractor has a clear understanding of what is required to perform the requested duties and the rates presented are correct as per contract DACW56-01-D-1005. It is therefore my opinion that we award ***** Inc. this task order #16.

PR & C #30130313 has been amended and certified for the final amount of \$ 5,504.00.

Marjorie Ellenberg Courtright, PLS

13-8. Labor Hour Task Orders for Construction Surveying Services

Fixed-price task orders under IDC are effectively used to provide a substantial amount of surveying and mapping services in USACE. However, fixed-price task orders are not usually appropriate for quality assurance and payment surveys of ongoing construction projects since the duration of the survey work is not within the control of the survey contractor. The surveyor contractor's progress is dependent on the progress of the construction contractor, which in turn, depends on weather, equipment malfunctions, unforeseen site conditions, material availability, labor problems, and many other factors. In such cases, a labor-hour task order is a very useful contracting mechanism. Labor-hour contracts (guidance also applicable to task orders) are covered in Federal Acquisition Regulation (FAR) Subpart 16.6. Labor-hour task orders are appropriate when the uncertainties involved in contract performance do not permit costs to be anticipated with sufficient accuracy or confidence to use a fixed-price task order. The contractor is required to apply its best efforts, but is not obligated to complete the assigned work within the task order ceiling price. Hence, a higher level of surveillance is required by the Government to ensure the contractor is performing as efficiently as possible and cost controls are being used. No special approvals are required to use labor-hour task orders, but the contracting officer must execute a determination and findings for the contract file explaining why no other contract type is suitable. There is no true negotiation, but rather an agreement on a realistic ceiling price considering the most likely conditions. All hourly costs for personnel and equipment (including direct overhead, G&A, and profit) are already established in the contract. The Government buys a certain amount of effort and has considerable control over how that effort is expended toward completion of the specified task. The Government can direct the contractor to start, pause, and stop work, within reasonable limitations. However, the Government bears the cost for disruptions in work. A labor-hour task order has the flexibility to follow the progress of the construction, without unfairly holding the survey contractor to a fixed price. The most cost-effective situation is where there is more than one project in the same area that can be surveyed using one task order. If there is a delay on one project, the survey crew can relocate to another project and resume work with minimal lost time. The following is an example of a Labor Hour task order scope.

LABOR HOUR TASK ORDER

Furnish all personnel, plant, equipment, transportation and materials necessary to perform, process and deliver the survey data described herein for construction stakeout and payment surveys in the following work areas in accordance with the general instructions and conditions set forth in Contract DACWXX-XX-D-XXXX:

- [List projects or work areas. Attach marked-up maps if needed. Describe work.]

Since it is not possible to accurately estimate the extent or duration of this work, this order will be issued on an estimated, not-to-exceed basis. The estimated quantities and ceiling price in accordance with the established contract rate schedule are as follows:

3-Person survey crew @ \$--/hour x [] hours =	\$ _____
Project manager @ \$--/hour x [] hours =	\$ _____
Ceiling price	\$ _____

It is estimated that this work will begin about [_(date)_] and be completed about [_(date)_]. The contracting officer's representative (COR) at the [] Project Office will advise the contractor at least [] hours in advance of when work must begin. The contractor may be directed to stop work at any time due to circumstances beyond the Government's control. If work is stopped at a work area, the contractor may be directed to relocate and start (or continue) work at one of the other work areas covered by this order, or to demobilize and return to the contractor's office. The contractor will be compensated at the hourly contract crew rate while stopped, relocating to another work area, demobilizing, or remobilizing (if required). There will be no compensation while the contractor is demobilized. The COR will advise the contractor at least [] hours in advance of when the contractor must remobilize and resume work.

The contractor will prosecute the work diligently and efficiently under the general direction and oversight of the COR. The contractor will provide a daily report, describing the work performed and hours worked, to the COR for certification. The daily reports will be used by the contractor to prepare monthly payment vouchers. With each monthly payment voucher, the contractor will estimate monthly and total earnings in the succeeding month, expressed both as total dollars and a percentage of the ceiling price.

The contractor will immediately notify the COR in writing when total estimated earnings reach 85 percent of the ceiling price. Also, if at any time the contractor projects that the total estimated earnings to complete the work will exceed the ceiling price, the contractor will promptly notify the COR and give a revised estimated total price with supporting reasons and documentation. The contracting officer will increase the ceiling price in writing if warranted or limit the work so as to remain within the current ceiling price. Exceeding the ceiling price is at the contractor's own risk.

[Insert technical requirements and deliverables.]

13-9. Hired-Labor Survey Cost Estimates

Cost estimates for USACE field forces engaged in topographic surveys are developed similarly to those for contracted field survey work described above. Normally, an average daily rate of personnel, travel, per diem, and equipment is established. Personnel labor costs are determined identically to those described above for A-E survey force labor--overheads are applied to the base wage rate of the government employee. Field crew personnel costs include direct labor, fringe benefits, technical indirect overhead, and direct overhead costs. Expenses for instrumentation and plant differ from commercial accounting methods since these charges are dependent on the method by which they were expensed at initial purchase. Equipment may be expensed against a single project account, or indirectly expensed against multiple projects. Land plant, floating plant, survey instrumentation, and CADD/computer systems may have established rental rates based on a revolving fund accounting process. Plant rental and survey equipment rental rates are usually developed at the time of purchase (or lease) may be periodically updated based on actual utilization rates as charged against projects. Various Plant Replacement and Improvement Program (PRIP) costs make up the expense. These daily plant rental rates may be recomputed annually, or more often if utilization changes significantly. The survey crew rate should also be periodically recomputed so that accurate and current cost estimates can be provided to requesting elements in a District.

Appendix A References

A-1. Required References

Bureau of the Budget 1947

Bureau of the Budget. 1947 (17 June). "United States National Map Accuracy Standards," US Bureau of the Budget.

Public Law 92-582

Brooks Architect-Engineer Act (10 US Code 541-544)

FM 3-34.331

Topographic Surveying

NOTE: The following Corps of Engineers publications can be downloaded from a link at:
<http://www.usace.army.mil>.

ER 405-1-12

Real Estate Handbook

ER 1110-1-8156

Policies, Guidance, and Requirements for Geospatial Data and Systems

ER 1110-2-1150

Engineering and Design for Civil Works Projects

EM 1110-1-1000

Photogrammetric Mapping

EM 1110-1-1002

Survey Markers and Monumentation

EM 1110-1-1003

NAVSTAR Global Positioning System Surveying

EM 1110-2-1009

Structural Deformation Surveying

EM 1110-1-2909

Geospatial Data and Systems

EM 1110-2-1003

Hydrographic Surveying

EP 715-1-7

Architect-Engineer Contracting

NOTE: The following CADD/GIS Technology Center publications can be downloaded at:
<https://tsc.wes.army.mil>

ERDC/ITL 1999a

"Computer-Aided Design and Drafting (CADD) and Geographic Information System (GIS)-- Concepts and Terminology, 1999," The CADD/GIS Technology Center, The CADD/GIS Technology Center, Information Technology Laboratory, U.S. Army Engineer Research and Development Center, Vicksburg, Mississippi 39180

ERDC/ITL 1999b

"CADD/GIS Technology Center Guidelines for Installation Mapping and Geospatial Data," 1999, The CADD/GIS Technology Center, The CADD/GIS Technology Center, Information Technology Laboratory, U.S. Army Engineer Research and Development Center, Vicksburg, Mississippi 39180

ERDC/ITL 2001

"A/E/C CADD Standard (TR-01-6)," September 2001, The CADD/GIS Technology Center, The CADD/GIS Technology Center, Information Technology Laboratory, U.S. Army Engineer Research and Development Center, Vicksburg, Mississippi 39180

ERDC/ITL 2002a

Spatial Data Standards for Facilities, Infrastructure, & Environment (SDSFIE) and Facility Management Standards for Facilities, Infrastructure, & Environment (FMSFIE)--History of Development and Benefits," June 2002, The CADD/GIS Technology Center, The CADD/GIS Technology Center, Information Technology Laboratory, U.S. Army Engineer Research and Development Center, Vicksburg, Mississippi 39180

ERDC/ITL 2002b

Spatial Data Standards for Facilities, Infrastructure, & Environment (SDSFIE) and Facility Management Standards for Facilities, Infrastructure, & Environment (FMSFIE)--Data Model and Structure," June 2002, The CADD/GIS Technology Center, The CADD/GIS Technology Center, Information Technology Laboratory, U.S. Army Engineer Research and Development Center, Vicksburg, Mississippi 39180

NOTE: The following FGDC publications can be downloaded at: <http://www.fgdc.gov>

FGDC 1998a

"Geospatial Positioning Accuracy Standards, PART 1: Reporting Methodology," Federal Geographic Data Committee, FGDC-STD-007.1-1998

FGDC 1998b

"Geospatial Positioning Accuracy Standards, PART 2: Standards for Geodetic Networks," Federal Geographic Data Committee, FGDC-STD-007.2-1998

FGDC 1998c

"Geospatial Positioning Accuracy Standards, PART 3: National Standard for Spatial Data Accuracy," Federal Geographic Data Committee, FGDC-STD-007.3-1998

FGDC 1998d

"Content Standard for Digital Geospatial Metadata (Version 2.0)," Federal Geographic Data Committee, FGDC-STD-001-1998

FGDC 2002

"Geospatial Positioning Accuracy Standards, PART 4: Standards for Architecture, Engineering, Construction (A/E/C) and Facility Management," Federal Geographic Data Committee, FGDC-STD-007.4-2002

NOTE: The following FGCS publications can be downloaded at: <http://www.ngs.noaa.gov/FGCS>

FGCS 1984

Federal Geodetic Control Subcommittee 1984

"Standards and Specifications for Geodetic Control Networks," Rockville, MD.

FGCS 1988

Federal Geodetic Control Subcommittee 1988

"Geometric Geodetic Accuracy Standards and Specifications for Using GPS Relative Positioning Techniques (Preliminary)", Rockville, MD. (Reprinted with Corrections: 1 Aug 1989).

NOTE: The following NOAA/NGS publications can be downloaded at: <http://www.ngs.noaa.gov>

NGS 1988

National Geodetic Survey 1988

"Guidelines for Submitting GPS Relative Positioning Data to the National Geodetic Survey"

NOAA 1994

"Input Formats and Specifications of the National Geodetic Survey Data Base," NOAA, National Geodetic Survey, September 1994.

NOAA 1997

NOAA Technical Memorandum NOS NGS-58, Zilkoski, D.B., D'Onofrio, J. D., and Frankes, S. J. (Nov 1997) "Guidelines for Establishing GPS-Derived Ellipsoid Heights (Standards: 2 cm and 5 cm)," Version 4.1.3. Silver Spring, Maryland.

TEC 2003

CVTPC ASCII Import MicroStation V8 Utility User's Manual, Version 4.5, US Army Topographic Engineering Center, March 2003 <http://crunch.tec.army.mil>

US Bureau of Land Management 1973

"Manual of Instruction for the Survey of the Public Lands of the United States"

USFS/BLM 2001

"Standards and Guidelines for Cadastral Surveys using Global Positioning System Methods," Version 1.0, 9 May 2001, USDA (Forest Service) and USDI (Bureau of Land Management)

A-2. Recommended Surveying Manuals and Textbooks

Anderson and Mikhail 1998

Anderson, James M. and Mikhail, Edward M., "Surveying: Theory and Practice," 7th Ed., McGraw Hill.

Brinker and Minnick 1995

Brinker, R.C., and Minnick, R., "The Surveying Handbook," 2nd Ed., New York, NY. Chapman & Hall.

CALTRANS Surveys Manual 2001-2004

"Surveys Manual", (14 chapters, various updates 2001-2004), California Department of Transportation, Division of Right of Way and Land Surveys, Office of Land Surveys. (Download entire manual at www.dot.ca.gov/hq/esc/geometronics)

Chen and Mikhail 1995

Chen, W.F., "The Civil Engineering Handbook: Section VII--Surveying Engineering," (Mikhail, E.M.), Boca Raton, FL. CRC Press.

Kavanagh 1997

Kavanagh, Barry, F. "Surveying With Construction Applications," 3rd Ed., Upper Saddle River, NJ, Prentice Hall.

Wolf and Brinker 1994

Wolf, Paul R., and Brinker, Russell C., "Elementary Surveying," 9th Ed., New York, NY. Harper Collins.

Wolf and Ghilani 2002

Wolf, Paul R., and Ghilani, Charles D., "Elementary Surveying--An Introduction to Geomatics," 10th Ed., Upper Saddle River, NJ. Prentice Hall.

A-3. Other Government and Industry Publications Cited in Manual

ALTA 1999

"Minimum Standard Detail Requirements for ALTA/ACSM Land Title Surveys," as adopted by the American Land Title Association and American Congress on Surveying and Mapping and National Society of Professional Surveyors, 1999 <http://www.acsm.net/alta.html>

ASPRS 1989

American Society for Photogrammetry and Remote Sensing. 1989. "ASPRS Accuracy Standards for Large-Scale Maps," *Photogrammetric Engineering and Remote Sensing*, pp 1068 and 1070. www.asprs.org/asprs/resources/standards.html

FAC 2003

Florida Administrative Code, Chapter 61G17, "Board of Professional Surveyors and Mappers," August 18, 2003. <http://www.myflorida.com>

Jacobs 2004

"Understanding the Useful Accuracy of Laser Scanners", Geoff Jacobs, Professional Surveyor Magazine, November 2004. <http://www.profsurv.com>

MNDOT 2000

"Surveying and Mapping Manual," Minnesota Department of Transportation, July 2000.
http://rocky.dot.state.mn.us/manual/SM/SM_Manual.pdf

Oregon DOT 2000

"Basic Surveying--Theory and Practice," 2000, Oregon Department of Transportation, Geometrics Unit, Salem, OR
<http://www.oregon.gov/ODOT/HWY/GEOMETRONICS/ManualsAndDocuments.shtml>

POB 2004a

"2004 Total Station Survey," March 2004, *Point of Beginning* magazine, BNP Media, Troy, MI.
<http://www.pobonline.com>

POB 2004b

"Data Collector Software Survey," November 2004, *Point of Beginning* magazine, BNP Media, Troy, MI.
<http://www.pobonline.com>

POB 2004c

"POB 2004 CAD/Surveying Software Survey," December 2004, *Point of Beginning* magazine, BNP Media, Troy, MI. <http://www.pobonline.com>

TDS 1999

"TDS-48GX--Surveying Card Tutorial Manual for use with the HP-48GX," 1991-1999, © Tripod Data Systems, Inc. Corvallis, OR. <http://www.tdsWay.com>

TDS 2004a

"ForeSight DXM User's Manual," 2004, © Tripod Data Systems, Inc. Corvallis, OR.
<http://www.tdsWay.com>

TDS 2004b

"ForeSight DXM Reference Manual", 2004, © Tripod Data Systems, Inc. Corvallis, OR.
<http://www.tdsWay.com>

Trimble 2001

"Trimble Survey Controller Reference Manual," Version 7.7, Revision A, Trimble Navigation Limited, Sunnyvale, CA. <http://www.trimble.com>

VADOT 2004

"Survey Manual 2004," Virginia Department of Transportation, Location and Design Division, 2004.
<http://www.extranet.vdot.state.va.us/locdes/GEOPAK/downloads/Survey1.zip>

EM 1110-1-1005
1 Jan 07

A-4. Superseded or Obsolete DA References

TM 5-232
Elements of Surveying (1971--Superseded by FM 3-34.331)

TM 5-235
Special Surveys

TM 5-237
Surveying Computers Manual (1964--Superseded by FM 3-34.331)

TM 5-241-2
Universal Transverse Mercator Grid--Zone to Zone Transformation Tables (1957)

TM 5-441
Geodetic and Topographic Surveying (1970)

TM 5-880-2
Planning for Emergency Construction: Surveys, Maps, and Construction Plans (1951)

NOTE: Archived copies of the above publications can be obtained from DOD library sources.

Appendix B

Requirements and Procedures for Referencing Coastal Navigation Projects to Mean Lower Low Water (MLLW) Datum

B-1. Purpose

This appendix provides guidance, technical considerations, and general implementation procedures for referencing coastal navigation projects to a consistent Mean Lower Low Water (MLLW) datum based on tidal characteristics defined and published by the US Department of Commerce. This guidance was originally issued as an Engineer Technical Letter in 1993 to implement applicable portions of Section 224 of the Water Resources Development Act of 1992. It is still applicable to those Corps projects that have not been fully converted to the latest reference datum or tidal epoch.

B-2. Applicability

This technical guidance in this appendix applies to Commands having responsibilities for design of river and harbor navigation projects on the Atlantic, Gulf, and Pacific coasts, and where such projects are subject to tidal influence.

B-3. References

- a.* Rivers and Harbors Appropriation Act of 1915 (38 Stat. 1053; 33 U.S.C. 562).
- b.* Water Resources Development Act of 1992 (WRDA 92), Section 224, Channel Depths and Dimensions.
- c.* EM 1110-2-1003 (*Hydrographic Surveying*).
- d.* EM 1110-2-1414 (*Water Levels and Wave Heights for Coastal Engineering and Design*).
- e.* Tidal Datum Planes, Special Publication 135, US Department of Commerce.
- f.* Manual of Tide Observations, Publication 30-1, US Department of Commerce.
- g.* Tide and Current Glossary, US Department of Commerce.
- h.* Statement of Work for the Installation, Operation and Maintenance of Tide Stations, US Department of Commerce.
- i.* User's Guide for the Installation of Bench Marks and Leveling Requirements for Water Level Stations, US Department of Commerce.
- j.* The National Tidal Datum Convention of 1980, US Department of Commerce.

B-4. Background

a. Depths of USACE navigation projects in coastal areas subject to tidal influences are currently referred to a variety of vertical reference planes, or datums. Most project depths are referenced to a local or regional datum based on tidal phase criteria, such as Mean Low Water, Mean Lower Low Water, Mean Low Gulf, Gulf Coast Low Water Datum, etc. Some of these tidal reference planes were originally derived from US Department of Commerce, National Ocean Service (NOS) observations and definitions used for the various coasts. Others were specifically developed for a local project and may be without reference to an established vertical network (e.g., National Geodetic Vertical Datum of 1929) or a tidal reference. Depending on the year of project authorization, tidal epoch, procedures, and the agency that established or connected to the reference datum, the current adequacy of the vertical reference may be uncertain, or in some cases, unknown. In some instances, project tidal reference grades may not have been updated since original construction. In addition, long-term physical effects may have significantly impacted presumed relationships to the NOS MLLW datum.

b. The National Tidal Datum Convention of 1980 established one uniform, continuous tidal datum for all marine waters of the United States, its territories, and Puerto Rico. This convention thereby lowered the reference plane (and tidal definition) of both the Atlantic and Gulf coasts from a mean low water datum to a MLLW datum. In addition, the National Tidal Datum Epoch was updated to the 1960-1978 period and mean higher/high water datums used for legal shoreline delineation were redefined. The latest tidal epoch update is the 1983-2001 period.

c. Since 1989, nautical charts published by NOAA reference depths (or soundings) to the local MLLW reference datum, also termed a "chart datum." US Coast Guard (USCG) Notices to Mariners also refer depths or clearances over obstructions to MLLW. Depths and clearances reported on USACE project/channel condition surveys provided to NOAA, for incorporation into their published charts in plan or tabular format, must be on the same NOS MLLW reference as the local chart of the project site.

d. WRDA 92, Section 224, requires consistency between USACE project datums and NOAA marine charting datums. This act amended Section 5 of the Rivers and Harbors Appropriation Act of 1915 to define project depths of operational projects as being measured relative to a MLLW reference datum for all coastal regions. (Only the Pacific coast was previously referenced to MLLW). The amendment states that this reference datum shall be as defined by the Department of Commerce for nautical charts and tidal prediction tables for a given area. This provision requires USACE project reference grades be consistent with NOS MLLW (latest epoch).

B-5. Impact of MLLW Definition on USACE Projects

a. Corps navigation projects that are referenced to older datums (e.g., Mean Low Water along the Atlantic coast or various Gulf coast low water reference planes) must be converted to and correlated with the local MLLW tidal reference established by the NOS. Changes in project grades due to redefining the datum from mean low water to NOS MLLW will normally be small, and in many cases will be compensated for by offsetting secular sea level or epochal increases occurring over the years. Thus, impacts on dredging due to the redefinition of the datum reference are expected to be small and offsetting in most cases.

b. All Corps project reference datums, including those currently believed to be on MLLW, must be checked to insure that they are properly referred to the latest tidal epoch, and that variations in secular sea level, local reference gage or benchmark subsidence/uplift, and other long-term physical phenomena are properly accounted for. In addition, projects should be reviewed to insure that tidal phase and range characteristics are properly modeled and corrected during dredging, surveying, and other marine

construction activity, and that specified project clearances above grade properly compensate for any tidal range variances. Depending on the age and technical adequacy of the existing MLLW reference (relative to NOS MLLW), significant differences could be encountered. Such differences may dictate changes in channels currently maintained. Future NOS tidal epoch revisions after the current 1983-2001 period will also change the project reference planes.

c. Conversion of project datum reference to NOS MLLW may or may not involve field tidal observations. In many projects, existing NOS tidal records can be used to perform the conversion, and short-term simultaneous tidal comparisons will not be required. Tidal observations and/or comparisons will be necessary for projects in areas not monitored by NOS or in cases where no recent or reliable observations are available.

B-6. Implementation Actions

A number of options are available to USACE commands in assessing individual projects for consistency and accuracy of reference datums, and performing the necessary tidal observations and/or computations required to adequately define NOS MLLW project reference grade. Datum establishment or verification may be done using USACE technical personnel, through an outside Architect-Engineer contract, by another Corps district or laboratory having special expertise in tidal work, or through reimbursable agreement with NOS. Regardless of who performs the tidal study, all work should be closely coordinated with both the USC&GS and NOS in the Department of Commerce.

a. *Technical specifications.* The general techniques for evaluating, establishing, and/or transferring a tidal reference plane are fully described in the USACE and Department of Commerce publications referenced in paragraph B-3. These references should be cited in technical specifications used for a tidal study contract or reimbursable agreement with another agency/command.

b. *Department of Commerce contacts.* Before and during the course of any tidal study, close coordination is required with the NOS.

c. *Sources.* If in-house forces are not used, the following outside sources may be utilized to perform a tidal study of a project, including any field tidal observations.

(1) Architect-Engineer (A-E) Contract. A number of private firms possess capabilities to perform this work. Either a fixed-scope contract or indefinite delivery contract form may be utilized. In some instances, this type of work may be within the scope of existing contracts. Contact NOS to obtain a typical technical specification which may be used in developing a scope of work. The references in paragraph B-3 of this appendix must be cited in the technical scope of work for the A-E contract.

(2) Reimbursable Support Agreement. Tidal studies and datum determinations may be obtained directly from the NOS, Department of Commerce, via a reimbursable support agreement. A cooperative agreement can be configured to include any number of projects within a district. Funds are provided to NOS by standard inter-agency transfer methods and may be broken down to individual projects. Contact the NOS to coordinate and schedule a study agreement.

d. *Scheduling of conversions.* Section 224 of WRDA 92 did not specify an implementation schedule for converting existing projects to NOS MLLW (or verifying the adequacy of an existing MLLW datum). It is recommended that a tidal datum study be initiated during a project's next major maintenance cycle.

e. Funding. No centralized account has been established to cover the cost of converting projects to NOS MLLW datum. Project Operations and Maintenance funds will be used to cover the cost of tidal studies and/or conversions on existing projects. For new construction, adequate funding should be programmed during the initial planning and study phases. Budget estimates for performing the work can be obtained from NOS.

f. MLLW relationship to national vertical network. USACE tidal benchmarks should be connected to the national vertical network maintained by the NOS--i.e., NAVD 88. Project condition surveys, maps, reports, studies, etc. shall clearly depict the local relationship between MLLW datum and the national vertical network.

g. Changes in dredging. It is not expected that the datum conversion will significantly impact dredging requirements. USACE commands should request HQUSACE guidance should a datum conversion cause a significant change in a channel's maintained depth.

Appendix C Development and Implementation of NAVD 88

C-1. General Background

This appendix provides technical guidance and implementation procedures for the conversion from the National Geodetic Vertical Datum of 1929 (NGVD 29) to the North American Vertical Datum of 1988 (NAVD 88). (This guidance was originally published as an Engineer Technical Letter in 1994 and is still generally applicable for projects not yet converted to NAVD 88. Note that some of the references are dated and network definitions have been modified by NOAA/NGS. The most recent guidance should be obtained from USACE and NOAA web sites listed at Appendix A).

a. The NAVD 88 is an updated vertical datum for North America that effectively covers Canada, Mexico, and the US. The new adjustment of the US National Vertical Control Network (NVCN) was authorized in 1978, and in 1982 the National Oceanic and Atmospheric Administration (NOAA) and Canada signed a Memorandum of Understanding (MOU) regarding the adoption of a common, international vertical control network called the NAVD 88.

b. The Federal Geodetic Control Subcommittee (FGCS) of the Federal Geographic Data Committee (FGDC) has adopted the new NAVD 88 datum. In addition, NAVD 88 was established in conjunction with the International Coordinating Committee on Great Lakes Basic Hydraulic and Hydrologic Data. This committee defined the IGLD 85, which was published for use in January 1992. IGLD 85 replaced IGLD 55.

C-2. References

a. Water Resources Development Act of 1992 (WRDA 92), Section 224, Channel Depths and Dimensions.

b. EM 1110-2-1003 (*Hydrographic Surveying*).

c. Converting the National Flood Insurance Program to the North American Vertical Datum of 1988: Guidelines for Community Officials, Engineers, and Surveyors, FEMA Report No. FIA-20, June 1992.

d. Results of the General Adjustment of the North American Datum of 1988, American Congress on Surveying and Mapping Journal of Surveying and Land Information Systems, Vol. 52, No. 3, 1992, pp. 133-149.

e. American Congress on Surveying and Mapping Ad Hoc Committee Report on NAVD 88, Special ACSM Report, 1990.

C-3. Discussion

a. NGVD 29 has been replaced by NAVD 88, an international datum adopted for use in Canada, the United States, and Mexico. NAVD 88 was established to resolve problems and discrepancies in NGVD 29. The adjustment of NAVD 88 was completed in June 1991 by the National Geodetic Survey (NGS), an agency of the Department of Commerce, National Oceanic and Atmospheric Administration (NOAA). NAVD 88 was constrained by holding fixed the height of a single primary tidal benchmark (BM) at Father's Point/Rimouski, Québec, Canada, and performing a minimally constrained general

adjustment of US-Canadian-Mexican leveling observations. The result of this adjustment is newly published NAVD 88 elevation values for benchmarks in the NGS inventory. Most Third Order BMs, including those of other Federal, state and local government agencies, were not included in the NAVD 88 adjustment.

b. The Federal Geodetic Control Subcommittee (FGCS) of the Federal Geographic Data Committee (FGDC) has affirmed that NAVD 88 shall be the official vertical reference datum for the US. The FGDC has prescribed that all surveying and mapping activities performed or financed by the Federal Government make every effort to begin an orderly transition to NAVD 88, where practicable and feasible.

c. Both tidal and non-tidal low water reference planes and datums are affected by the change to NAVD 88. The datum for the Great Lakes is now the International Great Lakes Datum of 1985 (IGLD 85). Unlike the prior datum (IGLD 55), IGLD 85 has been directly referenced to NAVD 88 and originates at the same point as NAVD 88. Elevations of reference points/datums along the various inland waterway systems will also be impacted by the change in datums.

d. The transition to NAVD 88 may have considerable impact on Corps projects, including maps, drawings, and other spatial data products representing those projects. However, once completed, the transition will result in a more accurate vertical reference datum that has removed leveling errors, accounts for subsidence, and other changes in elevation.

e. The computer program VERTCON can be used to make approximate conversions between NGVD 29 and NAVD 88. This program was developed by NGS and during the later part of FY94 has been incorporated into the USACE program CORPSCON. VERTCON conversions are intended for general small-scale mapping uses -- VERTCON should not be used for converting benchmark elevations used for site plan design or construction applications.

f. The conversion to NAVD 88 should be accomplished on a project-by-project basis. The relationship of all project datums to both NGVD 29 and NAVD 88 will be clearly noted on all drawings, charts, maps, and elevation data files.

g. In accordance with Section 24 of WRDA 92, when elevations are referred to a tidal reference plane in coastal waters of the US, Mean Lower Low Water (MLLW) shall be used as the vertical datum-- see Appendix B in this manual. Tidal BMs should be tied to NAVD 88 instead of NGVD 29 where NAVD 88 data is available. Tidal datums shall be established in accordance with the procedures outlined in EM 1110-2-1003 (*Hydrographic Surveying*).

h. Other hydraulic-based reference planes established by USACE for the various inland waterways, reservoirs, and pools between control structures should continue to be used for consistency; however, they should also be connected with the NAVD 88 where practicable and feasible.

i. In project areas where local municipal or sanitary jurisdictions have established their own vertical reference planes, every attempt should be made to obtain the relationship between that local datum and NGVD 29 and/or NAVD 88; and clearly note this relationship on all drawings, charts, maps, and elevation data files.

C-4. The National Vertical Control Network (NVCN): NGVD 29 and NAVD 88

a. The NVCN consists of a hierarchy of interrelated nets that span the United States. Before the adoption of NAVD 88, benchmark elevations of the NVCN were published as orthometric heights referenced to NGVD 29. NGVD 29 was established by the United States Coast and Geodetic Survey

(USC&GS) 1929 General Adjustment. NGVD 29 was established by constraining the combined US and Canadian first order leveling nets to conform to Mean Sea Level (MSL) as determined at 26 long-term tidal gage stations that were spaced along the east and west coast of North American and along the Gulf of Mexico, with 21 stations in the US and 5 stations in Canada.

b. Local MSL is a vertical datum of reference that is based upon the observations from one or more tidal gaging stations. NGVD 29 was based upon the assumption that local MSL at those 21 tidal stations in the US and 5 tidal stations in Canada equaled 0.0 foot on NGVD 29. The value of MSL as measured over the Metonic cycle of 19 years shows that this assumption is not entirely valid and that MSL varies from station to station.

c. The NGVD 29 was originally named the Mean Sea Level Datum of 1929. It was known at the time that because of the variation of ocean currents, prevailing winds, barometric pressures and other physical causes, the MSL determinations at the tide gages would not define a single equipotential surface. The name of the datum was changed from the Mean Sea Level Datum to the NGVD 29 in 1973 to eliminate the reference to sea level in the title. This was a change in name only--the definition of the datum established in 1929 was not changed. Since NGVD 29 was established, it has become obvious that the geoid based upon local mean tidal observations would change with each measurement cycle. Estimating the geoid based upon the constantly changing tides does not provide the most stable estimate of the shape of the geoid, or the basic shape of the earth.

d. The datum for NAVD 88 is based upon the mass or density of the Earth instead of the varying heights of the seas. Measurements in the acceleration of gravity are made at observation points in the network and only one datum point, at Pointe-au-Pere/Rimouski, Québec, Canada, is used. The vertical reference surface is therefore defined by the surface on which the gravity values are equal to the control point value. Although the international cooperation between the United States and Canada greatly strengthened the 1929 network, Canada did not adopt the 1929 vertical datum. The NGVD 29 was strictly a national datum. NAVD 88 is an international vertical datum for the US, Canada, and Mexico.

C-5. Distinction between Orthometric and Dynamic Heights

a. There are several different reference elevation systems used by the surveying and mapping community. Two of these height systems are relevant to IGLD 85: orthometric heights and dynamic heights. Geopotential numbers relate these two systems to each other. The geopotential number (C) of a BM is the difference in potential measured from the reference geopotential surface to the equipotential surface passing through the survey mark. In other words, it is the amount of work required to raise a unit mass of 1 kg against gravity through the orthometric height to the mark. Geopotential differences are differences in potential which indicate hydraulic head. The orthometric height of a mark is the distance from the reference surface to the mark, measured along the line perpendicular to every equipotential surface in between. A series of equipotential surfaces can be used to represent the gravity field. One of these surfaces is specified as the reference system from which orthometric heights are measured. These surfaces defined by the gravity field are not parallel surfaces because of the rotation of the earth and gravity anomalies in the gravity field. Two points, therefore, could have the same potential but may have two different orthometric heights. The value of orthometric height at a point depends on all the equipotential surfaces beneath that point.

b. The orthometric height (H) and the geopotential number (C) are related through the following equation:

$$C = G \cdot H$$

(Eq C-1)

where G is the gravity value estimated for a particular system. Height systems are called different names depending on the gravity value (G) selected. When G is computed using the Helmert height reduction formula that is used for NAVD 88, the heights are called Helmert Orthometric Heights. When G is computed using the International Formula for Normal Gravity, the heights are called Normal Orthometric Heights. When G is equal to normal gravity at 45 deg latitude, the heights are called Normal Dynamic Heights. It should be noted that dynamic heights are just geopotential numbers scaled by a constant, using normal gravity at 45 deg latitude equal to 980.6199 gals. Therefore, dynamic heights are also an estimate of hydraulic head. In other words, two points that have the same geopotential number will have the same dynamic height.

c. IGLD 55 is a normal dynamic height system that used a computed value of gravity based on the International Formula for Normal Gravity. Today, there is sufficient observed gravity data available to estimate "true" geopotential differences instead of "normal" geopotential differences. The "true" geopotential differences, which were used in developing IGLD 85 and NAVD 88, will more accurately estimate hydraulic head.

C-6. Problems with NGVD 29 and Why a New Datum needed to be Established

a. Approximately 625,000 km of leveling have been added to the National Geodetic Reference System (NGRS) since the 1929 adjustment. Each new line has been adjusted to the network. The new leveling data uncovered some problems in NGVD 29. Through the years, the agreement between the new leveling and the network BM elevations slowly grew worse. An investigation of NGVD 29 general adjustment results indicates that large residuals were distributed in some areas of the country during that adjustment. For example, the accumulated 1929 adjustment correction along a 3000 km east-west leveling route from Crookston, Minnesota, to Seattle, Washington is a delta of 89 centimeters (cm).

b. Inconsistencies in NGVD 29 have increased over the years. This increase is a function of factors such as:

(1) Many BMs were affected by unknown vertical movement due to earthquake activity, post-glacial rebound, and ground subsidence.

(2) Numerous BMs were disturbed or destroyed by highway maintenance, building, and other construction.

(3) New leveling became more accurate because of better instruments, procedures, and improved computations. It was decided in 1977 that the high accuracy achieved by the new leveling was being lost when forced to fit the 1929 network, and plans were made to begin developing a new national vertical network.

c. These inconsistencies have not always been apparent to the user since NGS has periodically readjusted large portions of the NVCN and spread these large residuals over large areas. Eventually, however, there would be a large number of areas in which surveyors would not be able to check their work using NGVD 29. NAVD 88 is specifically designed to remove the inconsistencies and distortions such as those found in the NGVD 29. NGS has held off incorporating approximately 40,000 km of newer leveling data for these reasons. These data were incorporated into the NAVD 88.

C-7. Selection of the Adjustment Method for NAVD 88

a. The FGCS created a Vertical Subcommittee in 1989 to study the impact of the NAVD 88 on the programs of member agencies and to recommend a datum definition. Several different datum definitions for NAVD 88 were studied by the subcommittee and the three options below were selected for final consideration:

- (1) Fix the elevation or mean sea level at a single point.
- (2) Fix mean sea level at four tide gages located at the network corners.
- (3) Fix the NGVD 29 elevations at 18 existing, well-scattered BMs.

b. Two options were considered for the establishment of the vertical datum: (1) tidal epoch or (2) a minimally constrained adjustment. The tidal epoch option required that the adjustment hold MSL fixed at all appropriate primary tide stations and use the latest available tidal epoch. This definition is actually the same as NGVD 29, but used the latest data available. The other option used a minimally constrained adjustment holding local MSL fixed at one primary tide station and adjusting all leveling data to it. This second option would maintain the integrity of the leveling data but would also create the greatest deviation from the presently published data.

c. Research was done by NGS to determine which option would be the best choice. To assist in the NAVD 88 datum definition decision, several adjustments were performed using different constraints. The results obtained from several trial adjustments indicate that no matter which datum definition scenario is chosen for NAVD 88, including a minimally constrained adjustment that changes in absolute heights of as much as 75 to 100 cm would exist between NGVD 29 and NAVD 88.

d. In addition to the NGS research, agencies and appropriate bodies were queried to determine which option would be their preference and to ask for recommendations. The FGCS and the American Congress on Surveying and Mapping (ACSM) established committees to investigate the impact of NAVD 88 on their members' activities and the activities of others in the community. Members of these committees were requested to provide documentation on the affects that the readjustment would have on their user populations and to include specific examples describing the real impact of a new vertical datum on their products. USACE was included in the questionnaire survey.

e. As a preliminary measure, both committees drafted recommendations for NAVD 88 and specified that NGS should:

- (1) Perform minimally-constrained least squares adjustment of the data for NAVD 88.
- (2) Shift the datum vertically to minimize recompilation of National Mapping Products.
- (3) Develop computer transformation software to convert between NGVD 29 and NAVD 88. ("VERTCON").
- (4) Develop national and/or regional geoid models to ensure GPS height differences meet at least 2nd Order, Class II FGCS precise geodetic leveling standards for accuracy.

f. Results indicated that the tidal epoch option would minimize the magnitude of the changes from NGVD 29 to NAVD 88 and thus possibly allow direct comparison of present hydrographic survey elevations with the proposed new NAVD 88 elevations. The smaller change between elevations would

cause less confusion and concern over flow heights, and the like. Regardless of the datum definition selected, large differences would exist between the NAVD 88 and the NGVD 29 heights. It should be noted that the NAVD 88 heights are better estimates of orthometric heights than the NGVD 29 heights. Better estimates of orthometric heights will become more critical in the future as surveying techniques continues to become more sophisticated and more accurate. The improved accuracy of geoid height determinations using GPS data requires the best estimate of true orthometric heights. Many cartographers want heights on their maps based on the best estimate of true orthometric heights.

C-8. The NAVD 88 Adjustment

a. The NAVD 88 adjustment is the culmination of over ten years of work. This effort has included: establishing about 100,000 km of trunk line leveling to reinforce weak areas in the network; modernizing the vast amount of leveling observation and description data that has been collected for over a century; performing adjustments of sections of the network to verify the quality of the observation data; informing the public users of the network of the pending change and determining the impact on the nation's engineering activities. After the datum definition was selected to be a minimally constrained adjustment, the final task of this effort was to perform the least squares adjustment of the whole network.

b. The general adjustment of NAVD 88 was completed in June 1991. The primary network consists of 200 loops containing 909 junction BMs. The network connects to 57 primary tidal stations, which are part of the National Primary Tidal Network, and 55 international water-level stations along the Great Lakes. In addition, 28 border connections were made to the Canadian vertical control network and 13 to the Mexican vertical control network. Third Order BMs of other agencies (e.g., USACE) were not included in this adjustment. The 500,000 BMs established by the USGS were also not placed in computer readable form and therefore will not have NAVD 88 heights. In addition, USACE commands have established thousands of BMs that will not have NAVD 88 heights.

c. A particular concern for the developers of the NAVD 88 was how to resolve the many issues associated with the National Mapping Program (NMP) of USGS and the National Map Accuracy Standard (NMAS). The NMP includes more than 83,000 different map products of which over 7 million copies are distributed annually. Almost all of these products contain elevation information as contours and spot elevations on maps or as elevation arrays in Digital Elevation Models. Changing these products, both graphical and digital, to the NAVD 88 will be a massive and costly undertaking and will require a decade or more to complete.

d. The new leveling data have additional corrections applied for refraction and rod correction and are adjusted in geopotential units rather than the orthometric system used in the past. The datum definition is the most scientifically acceptable of all the definitions considered and is the most natural because it is based on an undisturbed representation of the Earth's gravity field. It is the most suitable for the geoid height computations needed for the reduction of GPS ellipsoidal heights. The main disadvantage is the differences with MSL on the west coast. At Seattle, a person standing on the zero elevation contour (NAVD 88) will barely have their head above water at mid-tide.

e. Preliminary analysis indicates that the overall differences between orthometric heights referred to NAVD 88 and to the NGVD 29 range from approximately -40 cm to +150 cm. Most surveying applications should not be significantly affected because the changes in relative height between adjacent BMs in most geotechnically stable areas should be less than 1 cm. In many geotechnically stable areas, a single bias factor describing the difference between NGVD 29 and NAVD 88 can be estimated and used for most mapping applications. This was a significant consideration for assessing the impact on the national mapping products. The absolute height values will change much more, but this should not be the surveyor's biggest concern, since he/she should be concerned with ensuring that all height values of BMs

are referenced to the same vertical datum. The overall differences between dynamic heights referred to the IGLD 85 and to IGLD 55 will range from approximately 1 to 40 cm.

C-9. International Great Lakes Datum of 1955 (IGLD 55)

a. IGLD 55 is a datum common to the United States and Canada and is defined by international agreement. Before the establishment and adoption of the IGLD 55, the differences in elevation between the lakes had been determined but had not been connected to sea level and lake level data published from the United States and Canada did not match for the same lakes and rivers. The IGLD 55 was an international cooperative effort between the those two countries, the result of which was that the Great Lakes-St. Lawrence River system was then covered by a single uniform vertical control network. The IGLD 55 is different and separate from the NGVD 29.

b. IGLD 55 is by definition a hydraulic (i.e., dynamic) datum. The reference zero for IGLD 55 is based on mean water level surface at Father's Point (Pointe-au-Pere), Québec, Canada. Holding this point fixed determined the IGLD 55 datum. A procedure termed a "water level transfer" has been used to establish a local vertical datum on each of the Great Lakes. Research has concluded that the water level transfer technique was concluded to be at least as accurate as First Order, Class I geodetic leveling. The remaining lakes were incorporated using a combination of level lines and water level transfers. Adjusted elevations on the IGLD55 are referenced using the dynamic number system. The dynamic value of a benchmark is not a true linear elevation, but a serial number given to the level surface on which the mark lies. Dynamic elevations were adopted for the IGLD 55 primarily because they provide a means by which the geopotential hydraulic head can be measured more accurately between two points.

c. The earth's crust experiences movements around the entire Great Lakes and St. Lawrence River area. Therefore, the vertical reference datum for this area must be vertically readjusted every 25 to 30 years. This crustal movement is called "isostatic rebound," which is the gradual rising of the earth rebounding from the weight of the glaciers during the last glacial age. When IGLD 55 was created, it was known that readjustment would be necessary due to the effects of isostatic rebound. Crustal movement is not uniform across the Great Lakes basin and causes benchmarks to shift not only with respect to each other, but also with respect to the initial reference point. Subsidence and other local effects can cause benchmarks to shift as well.

C-10. International Great Lakes Datum of 1985 (IGLD 85)

a. The Coordinating Committee on Great Lakes Basic Hydraulic and Hydrologic Data revised the IGLD 55 datum and established IGLD 85. This committee has input to the international management of the Great Lakes-St. Lawrence River system. Representatives from the US and Canada are members on this committee. The efforts of the Coordinating Committee to revise IGLD 55 and establish IGLD 85 were coordinated with the efforts to establish the new common international vertical datum for the US, Canada and Mexico, NAVD 88.

b. The IGLD 85 is the current vertical control reference system in the Great Lakes Basin. The IGLD 55 was the vertical control reference system for this area until the publication of the IGLD 85 in January 1992. Originally, an IGLD 80 had been planned, but the project was extended. The epoch that was actually used to determine the mean water level for the new datum was from 1983-1988, of which the mean year is 1985. The reference zero point for IGLD 85 is located at benchmark #1250G, located at Rimouski, Québec. This benchmark has an IGLD85 elevation of 6.723 meters and IGLD 55 elevation of 6.263 meters. IGLD 85 increases the number and accuracy of benchmarks in the Great Lakes area. Corps districts were targeted to have converted over to IGLD 85 by January of 1993. This cannot be practically done until NOAA publishes complete IGLD 85 BM data for the area. IGLD 85 data is

available for the gages, but the spacing of the gages is not dense enough to support conversion of local project control.

c. Agencies in the US and Canada will use IGLD 85. The National Oceanic Service (NOS) and the Canadian Hydrographic Service (CHS) began reporting water levels referenced to IGLD 85 upon its implementation in January 1992. For a period of time, conversion factors for both IGLD 55 and IGLD 85 water level data will be provided by NOAA/NOS Great Lakes Section and CHS. The monthly water level bulletins published by USACE and CHS will reflect this information.

d. IGLD 85 will not change water levels established for federal flood insurance programs in the US. These levels will be referred to NAVD 88. Elevations common to both NAVD 88 and IGLD 85 are available from NOAA. Lake level outflows also will not be affected by the datum change to IGLD 85. As benchmark information becomes available, navigation, construction, and other improvement work on the Great Lakes should be referred to IGLD 85. Either datum is acceptable until the benchmark data is available for the respective USACE District or project area. Drawings shall include a note for the vertical IGLD datum in use to avoid blunders. USACE permit applications will still be referenced to the Ordinary High Water Mark (OHWM) as defined under Section 10 of the Rivers and Harbors Act. As benchmark information becomes available, new applications should reference IGLD 85.

C-11. NAVD 88 and IGLD 85

a. The specific needs of the Great Lakes system were taken into account while the decision was being made about how NAVD 88 was to be established. Analyses of data in the Great Lakes Basin was used to determine the effects of the datum constraint, magnitudes of height changes from the IGLD 55, deficiencies in the network design, selection of water-level station pairs to be used to generate zero geopotential difference observations, and additional re-leveling requirements. This coordination provided a check on the accuracy of the work and established a conversion between the IGLD 85 and NAVD 88.

b. Elevations referenced to NGVD 29 are unacceptable for use in resolving the involved problems of the Great Lakes System. The reference zero for NGVD 29 is not located within the Great Lakes system and orthometric elevations are not sufficient for use with large bodies of water such as the Great Lakes. The dynamics of large bodies of water are not modeled well by considering them as single equipotential surfaces. Other forces such as gravity must be considered. For example, water level measurements obtained at both ends of the Lake and connected to the NGVD 29 would show some magnitude of a permanently northerly slope.

c. The general adjustment of the NAVD 88 and IGLD 85 is one and the same. A minimum constraint adjustment of Canadian-Mexican-US leveling observations was performed holding fixed the height of the primary tidal BM, referred to the new IGLD 85 local mean sea level height value, at Father's Point/Rimouski, Québec, Canada. This constraint satisfies the requirements of shifting the datum vertically to minimize the impact of NAVD 88 on USGS mapping products, as well as provides the datum point desired by the IGLD Coordinating Committee for IGLD 85. The only difference between IGLD 85 and NAVD 88 is that IGLD 85 BM values are given in dynamic height units and NAVD 88 values are given in Helmert orthometric height units. The geopotential numbers of BMs are the same in both systems.

d. Geopotential numbers from the general adjustment of NAVD 88 were used to compute IGLD 85 dynamic heights. They will provide the best estimate of hydraulic head. If secondary gage data are placed in computer readable form, they will also be incorporated into NAVD 88 and IGLD 85. NGS will publish NAVD 88 heights and provide, upon special request, geopotential numbers for all BMs included in NAVD 88.

e. The use of GPS data and a high-resolution geoid model to estimate accurate GPS-derived orthometric heights will be a continuing part of the implementation of NAVD 88 and IGLD 85. It is important that users initiate a project to convert their products to NAVD 88 and IGLD 85. The conversion process is not a difficult task, but will require time and resources. Other local reference planes have been established by local jurisdictions and these can be referenced to either IGLD 85 or NAVD 88.

C-12. Low Water Reference Planes (LWRP)

a. On the Mississippi River between the mouths of the Missouri and the Ohio Rivers (the Middle Mississippi River), depths and improvements are referenced to a LWRP. No specific LWRP year is used for the Middle Mississippi north of Cairo, IL. Below Cairo, IL, depths and improvements along the Lower Mississippi River are referenced to the 1974 LWRP. This is also a hydraulic reference plane, established from long-term observations of the river's stage, discharge rates, and flow duration periods. The low water profile was developed about the 97-percent flow duration line. The elevation of the 1974 LWRP drops gradually throughout the course of the Mississippi, however, some anomalies in the profile are present in places (particularly in areas containing rock bottoms or groins/weirs). The gradient is approximately 0.5 feet per river mile. The ever-changing river bottom will influence the 1974 LWRP. Changes in the stage-discharge relationship will influence the theoretical flow line for the 1974 LWRP.

b. Construction and improvements along the lower river are performed relative to the 1974 LWRP at a particular point. Differences in 1974 LWRP elevations between successive points along the river are determined from simultaneous staff readings and are referenced to benchmarks along the bank. The 1974 LWRP slope gradients between any two points must be corrected by linear interpolation of the profile. Thus, over a typical 1-mile section of river with a 0.5-foot gradient, each 1000-foot C/C river cross section will have a different 1974 LWRP correction, each dropping successively at approximately 0.1-foot increments.

c. Where practicable and feasible, NAVD 88 should be used as the common reference plane from which 1974 LWRP elevations are measured. The relationship of all project datums to both NGVD 29 and NAVD 88 should be clearly noted on all drawings, charts, maps, and elevation data files. All initial surveys should be referenced to both NAVD 88 and NGVD 29. If this is not feasible, then NGVD 29 should be used as the common reference plane from which 1974 LWRP elevations are measured until the move to NAVD 88 can be accomplished. Differences between the 1974 LWRP and NGVD 29 are published for the reference benchmarks used to control surveys and construction activities. In some districts, surveys are performed directly on NGVD 29 without regard to the 1974 LWRP profile (i.e., elevations above NGVD 29 are plotted rather than depths below 1974 LWRP). The 1974 LWRP depths are then contoured from the plotted NGVD 29 elevations, with the 1974 LWRP profile gradients applied during the contouring process. If a survey is conducted over a given reach of the river, the 1974 LWRP-NAVD 88 and/or the 1974 LWRP-NGVD 29 conversion must be interpolated based on the slope profile over that reach.

d. Controlled portions of the Upper Mississippi are referred to pool levels between the controlling structures. Although a variety of reference datums are used on other controlled river systems or impoundment reservoirs, most are hydraulically based and relate to some statistical pool level (e.g., "normal pool level," "flat pool level," "minimum regulated pool level," etc.).

e. On the Mississippi River above Melvin Price Locks and Dam at Alton, IL, to Lock and Dam No. 22 at Saverton, MO, the reference used is related to the minimum regulated pool elevation. These pools are regulated referenced to a "hinge point." The pools are drawn down when the river's flow will provide adequate navigation depths naturally. When the flows are reduced to low volumes, the pools are

reestablished and are essentially level. The depths and improvements along this reach of the Mississippi River are referenced to the "minimum regulated pool" elevations.

f. On the Mississippi River above Lock and Dam No. 22 at Saverton, MO, to St. Paul, MN, a "flat pool level" reference is used, and soundings are shown as "depth below flat pool." The flat pool is the authorized elevation of the navigation project and can be referenced to any number of local datums. Most commonly, this level is referenced to the mean sea level (MSL) datum of 1912, the general adjustment which preceded 1929. Conversions between MSL 1912 and NGVD 29 are available. The Illinois Waterway pool elevations are referred to NGVD 29, however, relationships to numerous other datums are also made.

g. Vertical clearances (bridges, transmission lines, etc.) are usually measured relative to high and low waters of record, or relative to full pool elevations. Shore lines shown on river drawings and navigation maps may be referenced to a low water datum (i.e., 1974 LWRP). On the Mississippi River above Lock and Dam No. 22 at Saverton, MO, the plotted shoreline is referenced to full pool stage at dams with discharges equaled or exceeded 90 percent of the time. Given the variety of reference levels, special care must be taken to properly identify the nature and source of all vertical reference datums used on a project. The datum notes should include and clearly depict the relationship to NAVD 88.

Appendix D

Sample Scopes of Work and Guide Specifications for Topographic Surveying Services

D-1. General

This appendix contains sample scopes of work, technical specifications, and guide specifications for performing topographic surveys on military and civil works projects, as listed below. These specifications are intended to provide general guidance if one is developing criteria for a similar project. Portions or combinations of these sample specifications may be extracted to develop specific technical specifications. Sample specifications are provided for general IDC task orders; however, the last section contains a guide specification for use in preparing the overall Architect-Engineer (A-E) Indefinite Delivery Contracts (IDC). A typical state DOT topographic specification is also included at section D-7.

D-2. Generic Topographic Survey Specifications for a Task Order (Military Project)

D-3. Technical Specifications for Topographic and Cadastral Surveys of Storm Water Treatment Area. Consolidated Everglades Restoration Project--Indian River Lagoon (Jacksonville District)

D-4. Scope of Work for Topographic Survey of Dining Facility/Modularity Temporary Facilities (Site and Utility Work), Ft. Hood, Texas-- (Ft. Worth District)

D-5. Technical Specifications for a Topographic Survey of a Scour Erosion Area (Tulsa District)

D-6. Jacksonville District Plane Table Topographic Survey Specifications (1989)

D-7. Typical State DOT Control and Topographic Survey Specification (Florida Department of Transportation)

D-8. Guide Specification for Developing a Topographic Surveying Indefinite Delivery Contract

D-2. Generic Topographic Survey Specifications for a Task Order (Military Project)

The following specification is representative of those written for detailed site plan surveys of a proposed construction project on a military installation.

**DETAILED SPECIFICATIONS
SITE PLAN TOPOGRAPHIC SURVEYS AND UTILITY MAPPING
CONTRACT NUMBER DACWXX-_____
TASK ORDER NO. _____**

1. PROJECT: Commissary Renovation Project
2. LOCATION: Fort Swampy, Huntsville, Alabama
3. GENERAL: Perform field topographic, planimetric, and utility surveys, office computations, and 3D digital mapping for use in developing construction Plans and Specifications for subject project, as detailed in this scope of work.
4. SPECIFIC REQUIREMENTS:
 - a. Horizontal control for the project shall comply with Corps of Engineers Third-Order standards as outlined in EM 1110-1-1005.
 - b. Vertical control shall be Fourth-Order per EM 1110-1-1005.
 - c. Using control (NAD 83 and NGVD 29) provided by the Government, the Contractor shall lay out horizontal and vertical control in project areas using standard total station traverse and differential leveling survey methods. Control points shall be semi-permanent (re-bar w/cap) and set in a manner that they can be used for layout during construction. From said control points, the Contractor shall acquire field topographic (cross-sections or random topo) and planimetric information (buildings, roads, parking areas, sidewalks, fence lines, structures, drainage, etc.) to be used for 40 scale mapping with a one (1) foot contour interval. Density of field elevations shall support 1" = 40' mapping and shall be provided as necessary to show all breaks in grade or changes in terrain. Also the Contractor shall locate and tie individual trees (size and species) in the project area. All elevations shall be taken to the hundredth of a foot. All horizontal and vertical data will be collected with an electronic data collector using the Government- furnished data collection codes. This will include setups, backsights, measure ups, shot numbers, and shot descriptions. The Contractor shall record supplemental descriptive data in a standard field book. The Contractor shall furnish the Government the raw data collector field files (collection and the edited and compiled field file) along with the final coordinate file for all work. Vertical control for utilities shall be taken with a total station instrument, with measure downs for the invert elevations. All vertical control for utilities shall be recorded in field along with any sketches required. Utility information is required for the following:
 - (1) Water - Locate all valves, standpipes, regulators, etc. Locate all fire hydrants. Provide an elevation on top of valve case and top of valve. Provide size of pipe and distance above ground for standpipes.
 - (2) Sanitary Sewer - Locate all manholes and provide top of rim elevation along with an invert elevation of all pipes connected to the manhole. Identify type, size, and direction of each pipe.
 - (3) Storm Drainage - Locate manholes and all other storm drainage structures such as culverts, headwalls, catch basins, and clean-outs. Provide top of manhole or top of catch basin elevation along with an invert elevation of all pipes connected to a manhole or catch basin and bottom elevation. Identify type, size, and direction of each pipe. Provide type, size, and invert elevation for all culverts.

(4) Electrical - Locate all power poles, guy wires, vaults, manholes, meters, transformers, electrical boxes, and substations. Obtain type and height of poles, number and size of transformers, number of crossarms, number of wires (electrical and communication), direction and low wire elevation at each pole. Provide top of rim or top of vault elevation, top of wire or conduit elevation, direction and bottom elevation of manholes and vaults. Provide size for all electrical vaults and boxes.

(5) Gas - Locate all valves, meters, and gas line markers. Provide elevation on top of valve case and on top of valve.

(6) Telephone - Locate all poles, manholes, boxes, etc. Provide top of rim elevation, top of wire or conduit elevation, direction and bottom of manhole elevation. Obtain type and height of poles, number of crossarms, number of wires and low wire elevation at each pole.

(7) Street Light - Locate all poles and provide type and height of poles. Identify number and type of lights on poles. If connected by wires, show direction and low wire elevation.

(8) Heating - Locate all steam manholes and vaults, filler pipes, underground fuel tanks, etc. Provide top of rim or top of vault elevation, top of pipe elevation, direction and bottom of pit elevation. Provide size of vault and all pipe sizes within manhole or vault.

(9) Fire Alarm - Locate any fire alarm systems (box with number), telephones (box with number), etc. in project.

d. All computations are to be arranged in a sequential and understandable order, with notes when appropriate so a review can be made with minimum reconstruction. The Contractor shall furnish the Government computer output of unadjusted bearings, azimuths, distances, and coordinates of all traverse points. The error of closure, both azimuth and positions, shall be shown. Final data will be adjusted by the compass method and will show the adjusted bearings, distances, and coordinates of all points surveyed. The Contractor shall provide a final list of coordinates for all points. The Contractor shall use the combined grid factor for all work. All level lines shall be reduced and adjusted in accordance with accepted procedures and practices. All computations shall be fastened into an 8-1/2" X 11" folder separated and labeled to indicate various facets of work (horizontal, vertical).

e. Field note books standards:

(1) Field books shall be in pencil, and neat, legible, and sequential. They will also show names of crew members and date at the beginning of each day.

(2) Each field book shall have an index. The serial number and type of instruments used will be shown on this page.

f. Target computer system. The Contractor shall provide interactive graphic and nongraphic data files that are fully operational on a computer system running MicroStation software, version X.X or better. The files shall be created using Government-furnished seed files to ensure compatibility with mapping procedures and standards.

g. Utility information. All utilities that are field tied shall be merged into the Government-furnished 1" = 40' topographic database. This includes showing manholes, valves, power poles, etc., and connecting lines. Also the attribute information (text) for each utility shall be placed in the data file. This can include but not be limited to top of rim elevations, invert elevations, pipe size, direction, top of valve elevation, etc. (See Government-furnished example.) All horizontal and vertical control established for ties shall be shown as a symbol with annotation. Also, see Appendix A to this specification for breakdown of level assignments, level symbology, and text size.

EM 1110-1-1005
1 Jan 07

h. Map symbols. All symbols shall conform with Government-furnished cell file (CIVSUR.CEL). See Appendix B to this specification for complete breakdown of cells.

i. Global origin. The Contractor shall use the standard global origin of zero "X" and "Y" coordinates at the lower left corner of the X-Y plane.

j. Views. Only view one (1) and five (5) will be active. All locks will be off except keypoint snap and all displays will be on except text nodes and grid.

k. Text/Font. Most map features constitute either graphics or text and are on separate levels. However, in some cases, text will be placed on the same level as the graphics. Examples of this would be the "S" embedded in the line for sanitary sewer or the "W" in the line for water. Font 24 shall be used for utility descriptions and font 127 for all remaining text. See Appendix A for breakdown of level assignments, level symbology, and text size.

5. SPECIAL REQUIREMENTS:

a. There shall be no cutting of trees, and brush cutting shall be kept to a minimum.

b. Excessive marking with paint, flagging, etc. will be avoided.

c. The Contractor shall comply with all applicable safety regulations of the current U.S. Army Corps of Engineers Safety and Health requirements manual EM 385-1-1, and shall acquaint himself and his personnel with the safety requirements governing the area in which the work is being done.

6. MATERIAL TO BE FURNISHED CONTRACTOR:

a. As-built utility maps (1" = 40') as required for areas of work.

(1) Storm drainage

(2) Sanitary sewer

(3) Water

(4) Electrical

(5) Street lighting

(6) Telephone

(7) Gas

(8) Fire alarm

(9) Heating

b. Control listing and map.

c. Collection Point Codes, font library (FONTLIB.NPS), cell file (CIVSUR.CEL), and seed file (SEED.DGN).

d. Field book example.

e. Final product example (1" = 40' plot).

f. Appendix A, Level Assignments and Symbology.

7. REVIEW/SUBMITTAL:

a. Initial submittal - The Contractor shall provide the Government one (1) completed design file and hard copy at 1" = 40' for review to assure compliance with project specifications. The Government reserves a period of five (5) calendar days to comment on this submittal.

b. Pre-final submittal - The Contractor shall generate 3D graphic files of utility data (MicroStation design files) and a 1" = 40' plot of all files for all areas. Digital data shall be supplied on DC/DVD media. The Government reserves a period of ten (10) calendar days to comment on Contractor's work.

c. Final submittal - The final submittal shall contain all the revisions required as a result of the Government's prefinal review. The final submittal shall consist of:

- (1) MicroStation design files on CD/DVD format
- (2) 1" = 40' hard-copy plots of individual data files
- (3) All items in paragraph 6 above
- (4) All computations (in folder)
- (5) All field books (reduced and checked)
- (6) CD/DVD containing raw field data and final coordinate data

8. REPORTS: The Contractor shall submit monthly progress status reports during the duration of the project.

9. SCHEDULE AND DELIVERY: The submission schedule shall commence on the day notice-to-proceed is issued and will run consecutively for the number of days shown in Appendix B. All submittals shall be accompanied by a letter of transmittal.

Enclosures:

Appendix A

Appendix B

(Appendices to be included in an actual scope of work.)

D-3. Technical Specifications for Topographic and Cadastral Surveys of Storm Water Treatment Area. Consolidated Everglades Restoration Project--Indian River Lagoon (Jacksonville District)

This technical scope involves a comprehensive topographic and planimetric survey of four sections (2,560 acres) of land situated in Indian River County, Florida. The entire area consists of 15 to 20 ft high orange and grapefruit orchards, and contains access roads, irrigation canals, and related pump systems. Both RTK and robotic total stations were used for these surveys. On this project, a robotic total station was set up atop a portable 25-ft triangulation tower, from which shots to a 20 ft prism rod cleared the tops of the orange trees. The following scope of work was developed by the Jacksonville District Survey Section and the work was performed under an IDC task order.

TECHNICAL QUALITY CONTROL REQUIREMENTS
PLANS AND SPECIFICATIONS SURVEY
CERP INDIAN RIVER LAGOON - SOUTH
C-23/24 STORM WATER TREATMENT AREA (STA)
ST. LUCIE, COUNTY, FORT PIERCE, FLORIDA
MAY 12, 2004, SURVEY 04-059

1. LOCATION OF WORK. *The work is located in the vicinity of Ft. Pierce, Florida, more specifically, the South half of Section 26, the South half of Section 27, and Sections 33, 34, and 35 all in Township 35 South, Range 38 East, Tallahassee Meridian. In addition, this survey will include the portion of C-24 canal that runs adjacent to Section 33, the portion of State Route 609 that is adjacent to the South half of Section 26 and Section 35, and the portion of State Route 613 between Sections 33 and 34, and is adjacent to the South half of Section 27.*

2. SCOPE OF WORK.

a. *Perform a complete cadastral and topographic survey of the Indian River Lagoon – South, C-23/24 Storm Water Treatment Area (STA), as outlined herein, on the enclosures and in the furnished CADD data. The purpose of this survey is to obtain data for the preparation of the plans and specifications for the subject project.*

b. *The services to be rendered by the contractor include all the work described in these technical requirements. Details not specifically described in these instructions are nevertheless a firm requirement if they can be identified as an item, or items, commonly a part of professional grade work of a comparative nature.*

c. *The contractor shall furnish all necessary materials, labor, supervision, equipment, and transportation necessary to execute and complete all work required by these specifications.*

d. *The Corps of Engineers, Survey Section shall be contacted the same day that the contractor plans to commence the work. The POC for this project is Jeffrey Navaille at (904) 232-2499.*

e. *A picture ID showing company name, date of birth, and driver's license number must be carried by personnel working on USACE projects.*

f. *Rights-of-Entry must be obtained verbally and recorded in the field book before entering private property. Enter the name and address of the property owner contacted.*

g. All Surveying and Mapping products and related work shall be in strict compliance with the applicable Engineering Manuals and with related technical standards and publications: (online at <http://www.usace.army.mil/publications/>)

- EM-1110-1-1000
- EM 1110-1-1002
- EM-1110-1-1005
- EM-1110-2-1003
- EM-1110-1-2909
- Tri-Services A/E/C CADD Standards, Spatial Data Standards and related Spatial Data Products
- Florida Statutes Chapter 177 (Parts I, II, and III), Chapter 472 (Land Surveying), and Rule Chapter 61G17-6, Florida Administrative Code (Minimum Technical Standards for Surveys).
- Bureau of Land Management Manual of Surveying Instructions, 1973 edition.
- Restoration of Lost or Obliterated Corners and Subdivision of Sections. (Bureau of Land Management).

h. Digital Geospatial Metadata. Metadata are "data about data." They describe the content, identification, data quality, spatial data organization, spatial reference, entity and attribute information, distribution, metadata reference, and other characteristics of data. Each survey project shall have metadata submitted with the final data submittal. All metadata submitted must be compliant with the Federal Geographic Data Committee Standard "Content Standard for Digital Geospatial Metadata," FGDC-STD-001-1998. This standard is available for download from www.fgdc.gov. A graphical, annotated workbook explaining the standard is available in PDF format at www.fgdc.gov. Furnish a digital file using Corpsmet95 Metadata Software. Corpsmet95 is available for download from www.corpsgeo1.usace.army.mil. All sections applicable to this collection effort must be completed. The point of contact in Survey Section for questions about metadata is Mr. Bill Mihalik at 904-232-1462.

i. The digital data shall be submitted on Recordable (CD-R) Compact Disk, media. Compact Disk, Rewritable (CD-RW) will not be accepted.

3. FIELD SURVEY EFFORT. The area of work is outlined on Enclosure 1: quad map, Enclosure 2: technical requirements, and Enclosure 3: control monument descriptions. This information will also be placed on the rocknet ftp site under pub/survey/fsi/04-059.

a. CONTROL. The base project control network (monumentation) must be referenced to the North American Datum 1983 (NAD 83/99) for a horizontal reference and both the North American Vertical Datum, 1988 (NAVD 88) and the National Geodetic Vertical Datum, 1929 (NGVD29) for a vertical reference. All control surveys shall be Third Order, Class II accuracy. The datums for the final mapping product shall be NAD83(99) and NAVD88.

(1) The basic control network may be accomplished using precise differential carrier-phase Global Positioning System (GPS) observations. Differential GPS baseline vector observations shall be made in strict accordance with the criteria contained in the engineering manual EM-1110-1-1003 and with the Geometric Geodetic Accuracy Standards and Specifications for Using GPS Relative Positioning Techniques as directed by the Federal Geodetic Control Committee, version 5.0.

(2) Network design, station and baseline occupation requirements, for static and kinematic (see para. 3a8.) surveys, satellite observation time per baseline, baseline redundancies, and connection requirements to existing networks, shall follow the criteria given in the above said engineering manual. A field observation log shall be completed at each setup in the field.

(3) GPS derived elevation data shall be supplied in reference to the above said datum. Existing benchmark data and stations shall be used in tandem in a minimally constrained adjustment program to model the geoid. All supporting data used in vertical adjustment shall be submitted. The GPS plan shall be submitted and approved by Mr. Jeffrey Navaille prior to commencing work.

(4) The GPS network shall commence from the control shown on Enclosure 3. All established or recovered control shall be fully described and entered in a FIELD BOOK, in accordance with the Technical Requirements of this contract. All control surveys shall be Third Order, Class II accuracy. The contractor shall submit the field data and abstracts for the control networks to Survey Section for review before commencing the mapping. The monument designations shall be furnished as requested.

(5) All horizontal and vertical control (double run forward and back) established shall be a closed traverse or level loop with no spur lines, and meeting third order accuracy. All horizontal and vertical control along with baseline layouts, sketches, and pertinent data shall be entered in field books.

(6) All monuments, survey markers, etc., recovered shall be noted on the copies of control descriptions. Control points established or recovered with no description or out-of-date (5 Years old) descriptions shall be described with sketches for future recovery use.

(7) All original field notes shall be kept in standard, pocket size, field books and shall become the property of the Government. The first four pages of the field books shall be reserved for indexing and the binding outside edge shall be free from all marking.

(8) REAL TIME KINEMATIC (RTK). Any contractor intending to utilize RTK will notify the COE prior to negotiation. The COE will provide technical requirements and will require a detailed survey plan from the contractor.

b. TOPOGRAPHIC DATA. It is requested that a comprehensive topographic survey be performed on the subject site. Observations shall be taken at a minimum frequency of 100-feet. The coverage and level of detail desired shall be such that a one-foot contour interval can be displayed from the resulting digital terrain model.

c. PLANIMETRIC DATA. All features within the survey limits (weirs, culverts, buildings, vegetation, roads, RR, debris, fence lines, structures, drainage, wells, etc.) shall be located. Provide detailed information on all features that would affect construction, i.e. invert elevation of outflow pipe, diameter of pipe, waterside length of pipe to discharge, invert elevation of pipe at discharge, elevations of top of weirs and define existing edge of water and vegetation/tree lines. Individual citrus trees do not need to be located. Trees of significant size on hammocks should be identified.

d. UTILITY INFORMATION. Locate and obtain basic information of any utilities (water, sewer, drainage, electrical, commutation, etc.) within the survey limits or nearby that would interfere with construction. Locate and detail culverts, above and below ground utilities (including pole locations and low wire elevations for high voltage transmission wires running parallel to the C-24 canal), above and below ground irrigation systems, fences, and all other structures.

e. BREAK LINES. Break lines shall be located for all natural or man-made features as needed. These include but are not limited to road edges, tops and toes of ditches and canals, and levee features. Any condition where a change in grade can be detected should be located. The break lines shall be located by X, Y, and Z coordinates and identified.

f. CADASTRAL DATA. Perform research and locate the necessary cadastral features in the project area to delineate and isolate areas that may be impacted by construction or other operations. Locate the exterior section boundaries of the lands described in the "Location of Work" portion of this document. Detailed individual parcel surveys are not required. Obtain data on the Rights-of-Way for all roads and for the C-24 canal. Also locate and delineate easements of record such that a final working area may be derived for project planning and execution.

4. DATA PROCESSING. The contractor shall make the necessary computations to verify the correctness of all measurements and apply the proper theory of location in accordance with the law or precedent and publish the results of the survey. The contractor shall submit advance copies of the

horizontal control so that the USACE can review. Compute and tabulate the horizontal and vertical positions on all work performed. Review and edit all field data for discrepancies before plotting the final drawings.

5. CADD. The survey data shall be translated or digitally captured into Bentley MicroStation J 3-D design files according to the specifications furnished. The survey data (cover, control, site plan, plan sheets, and section drawings) shall be provided in Bentley MicroStation J 3-D format. The neat mapping area on all sheets (covers and plans) shall be 30-inches by 25-inches.

a. GLOBAL ORIGIN. The Bentley MicroStation J 3-D design file shall be prepared with a global origin of 0, 0, 2147483.65, Design file master units: feet (Ft), sub units: thousands of a foot (Th.), sub per master: 1,000, and positional units per sub: 1. The file name shall be the survey number prefixed to an "f," i.e., f059S1.dgn. All reference files shall commence with the f059 prefix as well.

b. DIGITAL TERRAIN MODEL (DTM) DATA. The contractor shall develop and deliver a surface model for the entire survey area using Bentley Inroads SelectCAD compatible Digital Terrain Modeling software. The model file shall have the .dtm extension. The digital terrain model shall be developed from cross sections, spot elevations, and breaklines (when applicable). Breaklines should include ridges, drainage, road edges, surface water boundaries, and other linear features implying a change in slope. The surface model shall be of adequate density and quality to produce a one-foot contour interval derived from the original DTM (Digital Terrain Model) file. The contour data shall be incorporated as a reference file into the final data set. All data used to develop the DTM's shall be delivered in Bentley MicroStation J 3-D design files. The contours shall be developed in the digital terrain model (DTM). The contours shall be provided in one or more master database DGN files attached as a reference file to all sheets files utilizing the clip bounds methods. Each contour shall be drawn sharp and clear as a continuous solid line, dashed contours are not acceptable. Every index contour shall be accentuated as a heavier line than the intermediate and shall be annotated according to its actual elevation above datum. Whenever index contours are closer than one-quarter (1/4) inch, and the ground slope is uniform, the intermediate shall be omitted. Labeling or numbering of contours shall be placed on top of the contour line, so that the elevation is readily discernible, do not break contours. Labeling of intermediate contours may be required in areas of low relief.

c. MASTER DGN FILES.

(1) The survey data (DTM data points) points shall be provided in one or more master DGN file, attached as a reference file to all sheet files utilizing the clip bounds methods.

(2) The contours shall be provided in one or more master DGN files, attached as a reference file to all sheet files utilizing the clip bounds methods.

(3) The control and baselines shall be provided in one or more master DGN file, attached as a reference file to all sheet files utilizing the clip bounds methods.

(4) The planimetric detail, channel limits, and alignments shall be provided in one or more master DGN file, attached as a reference file to all sheet files utilizing the clip bounds methods.

(5) The breaklines shall be provided in one or more master DGN file, attached as a reference file to all sheet files utilizing the clip bounds methods DO NOT PLOT THE BREAKLINES.

(6) The cadastral data shall be depicted in one or more master DGN files, attached as a reference file to all sheet files utilizing the clip bounds methods. Show ROW points of intersection (PI) with corresponding X and Y coordinates in table format. Show section and property corners with X and Y coordinates in table format. Label bearings and distances on Section lines.

d. COVER AND CONTROL SHEET. The first sheet shall be the cover sheet to a scale that shows the survey limits in relationship to surrounding metro areas and access roads to site. In addition,

show the control sketch, survey control tabulation, sheet layout or index, legend, project location map, survey notes, north arrow, graphic scale, grid ticks, and large signature block. Tabulate, plot, and list the horizontal control used for the survey on the final drawings.

e. PLAN SHEETS. The plan sheets shall be prepared, to a scale of 1" = 100', in the Corps of Engineers format showing notes, title block, grid, north arrow, graphic scale, legend, sheet index, and D. O. File Number. The second sheet and all sheets following shall be a continuation sheet and shall have a minimum of two notes, note 1: See Drawing number 1 for notes, note 2: Refer to Survey No. 04-059.

f. TITLE BLOCKS. Standard title blocks shall be provided by the COE. Cell libraries are available on the District's home page and ftp site.

g. SECTION VIEWS. No section views are required per this survey.

h. FEATURE DETAIL VIEWS. Show, at an appropriate scale, any other needed feature detail within the survey limits.

6. MAP CONTENT.

a. COORDINATE GRID. Grid ticks (English) of the applicable State Plane Coordinate System shall be properly annotated at the top, bottom, and both sides of each sheet. Spacing of the grid ticks shall be five (5) inches apart.

b. CONTROL. All horizontal and vertical ground control monuments shall be shown on the maps in plan and tabulated. Aerotriangulation points (if applicable) shall be furnished if requested in digital form.

c. PLANIMETRIC. The maps shall contain all surface-visible land use, structural, and planimetric features which are visible or identifiable.

d. MAP EDIT. All names, labels, notes, and map information shall be checked for accuracy and completeness. All commercial buildings, roads, and man made features shall be labeled with purpose and name.

e. SHEET INDEX AND LEGEND. On plan drawings a small-scale sheet index shall be shown on each sheet of the series; highlighting the sheets in the standard manner. Planimetric and topographic feature legends shall be shown on each sheet. Contractor logo shall be shown on each drawing.

7. OFFICE REVIEW AND COMPUTATIONS. The contractor shall make the necessary computations to verify the correctness of all measurements and apply the proper theory of location in accordance with the law or precedent and publish the results of the survey. The contractor shall submit the original field notes and horizontal and vertical abstract (computation abstract) to Survey Section for review before mapping commences.

8. CONTRACTOR QUALITY CONTROL/GOVERNMENT QUALITY ASSURANCE.

The contractor is responsible for quality control. Government personnel may perform inspections of the contractor's field operations at any time during the prosecution of this work. The contractor shall explain calibration procedures and operational activities related to their field effort. If during the Government's review of the contractor's products it becomes apparent that little or no review has been done, the Government will return the entire project to the contractor for correction.

a. SURVEY/QUALITY CONTROL REPORT. The contractor shall furnish a digital (*.doc) file on the final CD. The report shall include Right-of-Entry information, descriptive text regarding control monuments recovered, destroyed, or reset included in the control network, tide gage location and monument used, dates of field survey collection, types of equipment used, quality control checks, and digital files. Unique circumstances and/or issues related to this survey, general approach/methodology to

this survey. Along with any other data required in accordance with the law or precedent and for the Corps of Engineers to publish the results of the survey.

9. DELIVERIES. On completion, all data required shall be delivered or mailed to Design Branch, Survey Section at the address shown in the contract, and shall be accompanied by a properly numbered, dated and signed letter or shipping form, in duplicate, listing the materials being transmitted. All digital data shall be submitted on CD-ROMs. All costs of deliveries shall be borne by the contractor. Items to be delivered include, but are not limited to the following:

- GPS network plan, (before GPS work commences).
 - GPS raw data along with field observation log sheets filled out in field with all information and sketches.
 - Raw data and computation files with horizontal and vertical abstracts along with any Q1 and Q2 files.
 - Digital survey/quality control report, including abstracts, computations, adjustments, and tabular summaries fully annotated with independent checks.
 - Field books.
 - Scanned field books (in adobe acrobat pdf format, one field book per file).
 - Furnish an ASCII file containing all data in the following format : X, Y, Z, and Descriptor.
 - If HYPACK software is utilized the HYPACK line files shall be provided to the COE on compact disk.
 - DGN and DTM files.
 - Advance paper plots (2 sets).
 - Metadata files (*.gen and *.met files).
-

D-4. Scope of Work for Topographic Survey of Dining Facility/Modularity Temporary Facilities (Site and Utility Work), Ft. Hood, Texas-- (Ft. Worth District)

This appendix illustrates a scope of work for 1 inch = 30 ft scale topographic mapping and extensive utility detailing. This scope was developed by the Ft. Worth District for work to be issued under an IDC Task Order.

CESWF-EC-DC

15 Sept 2004

MEMORANDUM FOR CESWF-PER-PE
ATTN: Steve Schultz

SUBJECT: Request for Services – Fort Hood, Texas
Modularity Temporary Facilities/ Site and Utility Work

1. GENERAL:

Perform field topographic, planimetric, and utility surveys, office computations, and 3D digital mapping for use in developing "Plans and Specifications" as detailed in this scope of work. The areas to be surveyed are identified on the attached drawings. Hatching on the attached drawings indicates the limits of the areas to be surveyed.

2. SPECIFIC REQUIREMENTS:

a. *Horizontal and Vertical control for the project shall comply with Corps of Engineers standards as outlined in EM 1110-1-1005. Horizontal control shall be based on Texas State Plane Coordinate System, Central Zone, NAD-83. Vertical control shall be based on NGVD-29. Use English units.*

b. *Use the control points previously provided by the Government for the Dining Facility survey. The contractor shall layout horizontal and vertical control in the identified project areas. A minimum of 5 control points shall be provided for each area surveyed. Control points shall be semi-permanent (rebar w/cap) and set in a manner that they can be used for layout during construction. The Contractor shall acquire field topographic (cross-sections or random topo) and planimetric information (buildings, roads, parking areas, sidewalks, fence lines, structures, drainage, etc.) to be used for 1" = 30' scale mapping with a 1-foot contour interval. Density of field elevations shall support 1" = 30' mapping and shall be provided as necessary to show all breaks in grade or changes in terrain. Also the Contractor shall locate and tie individual trees (size and species) in the project area. All elevations shall be taken to hundredths of a foot accuracy. All horizontal and vertical data will be collected with an electronic data collector. The Contractor shall record data in the field book. This will include setups, backsights, measure ups, shot numbers, and shot descriptions. The Contractor shall furnish the Government the field files (collection and the edited and compiled field file) along with the final coordinate file for all work. All applicable survey features and utility information shall be placed in the files mentioned below. Vertical control for utilities shall be taken with a total station instrument, with measure downs for the invert elevations. All vertical control for utilities shall be recorded in the field book along with any sketches required. Utility information is required for the following:*

Water - Locate all valves, standpipes, regulators, etc. Locate all fire hydrants. Provide an elevation on top of valve case and top of valve. Provide size of pipe and distance above ground for

standpipes. Locate all underground water lines, pipe sizes, and locations. Place all water utility information in a CADD file named **fh062530-V-wa----.dgn**.

Sanitary Sewer - Locate all manholes and provide top of rim elevation along with an invert elevation of all pipes connected to the manhole. Identify type, size, and direction of each pipe. Locate all clean-outs. Locate all Sanitary Sewer lines, pipe sizes. Provide distance to and top rim and invert for manholes or sanitary sewer structures at least one structure upstream and downstream for sanitary sewer lines that extend outside the cross-hatched or area identified to be surveyed. Place all sanitary sewer utility information in a CADD file named **fh062530-V-ss----.dgn**.

Industrial Waste - Locate all manholes and provide top of rim elevation along with an invert elevation of all pipes connected to the manhole. Identify type, size, and direction of each pipe. Locate all clean-outs. Locate all Industrial Waste lines, pipe sizes. Provide distance to and top rim and invert for manholes or Industrial Waste structures at least one structure upstream and downstream for Industrial Waste lines that extend outside the cross-hatched or area identified to be surveyed. Place all industrial waste utility information in a CADD file named **fh062530-V-iw----.dgn**.

Storm Drainage - Locate manholes and all other storm drainage structures such as culverts, headwalls, catch basins, and clean-outs. Provide top of manhole or top of catch basin elevation along with an invert elevation of all pipes connected to a manhole or catch basin and bottom elevation. Identify type, size, and direction of each pipe. Provide type, size, and invert elevation for all culverts. If only one structure on a gravity flow line falls within the hatched area shown on the drawing, provide distance and invert data for one structure both upstream and downstream of the site. Place all storm drainage utility information in a CADD file named **fh062530-V-st----.dgn**.

Electrical and Communication - Locate all power poles, guy wires, vaults, manholes, meters, transformers, electrical boxes, and substations. Obtain type and height of poles, number and size of transformers, number of conductors on each pole, including telephone and cable TV, number of cross arms, number of wires (electrical and communication), direction and low wire elevation at each pole. Provide top of rim or top of vault elevation, top of wire or conduit elevation, direction and bottom elevation of manholes and vaults. Provide size for all electrical vaults and boxes identify the size and number of ducts or cables entering each manhole and their invert elevations. Place all electrical utility information in a CADD file named **fh062530-V-eu----.dgn**. Place all communications utility information in a CADD file named **fh062530-V-cp----.dgn**.

Gas - Locate all valves, meters, and gas line markers. Provide elevation on top of valve case and on top of valve. Place all natural gas utility information in a CADD file named **fh062530-V-ng----.dgn**.

Telephone - Locate all poles, manholes, boxes, etc. Provide top of rim elevation, top of wire or conduit elevation, direction and bottom of manhole elevation. Obtain type and height of poles, number of crossarms, number of wires and low wire elevation at each pole. Place all communications utility information in a CADD file named **fh062530-V---cp.dgn**.

Streetlight - Locate all poles and provide type and height of poles. Identify number and type of lights on poles. If connected by wires, show direction and low wire elevation. Place this information in the CADD file **fh062530-V-eu----.dgn**.

Heating - Locate all steam manholes and vaults, filler pipes, underground fuel tanks, etc. Provide top of rim or top of vault elevation, top of pipe elevation, direction, and bottom of pit elevation. Provide size of vault and all pipe sizes within manhole or vault. Place all high temperature and chilled water utility information in a CADD file named **fh062530-V-ht----.dgn**.

Fire Alarm - Locate any fire alarm systems (box with number), telephones (box with number), etc. in project. Place this information in the CADD file **fh062530-V-cp----.dgn**.

c. All computations are to be arranged in a sequential and understandable order, with notes when appropriate so a review can be made with minimum reconstruction. The Contractor shall furnish the Government computer output of unadjusted bearings, azimuths, distances, and coordinates of all traverse points. The error of closure, both azimuth and positions, shall be shown. Final data will be adjusted by the compass method and will show the adjusted bearings, distances, and coordinates of all points surveyed. The Contractor shall provide a final list of coordinates for all points. All level lines shall be reduced and adjusted in accordance with accepted procedures and practices. All computations shall be fastened into an 8-1/2" X 11" folder separated and labeled to indicate various facets of work (horizontal, vertical).

d. Field note books standards:

- Field books shall be neat, legible, and sequential. They will also show names of crewmembers and date at the beginning of each day. All print and sketches shall be dark enough to produce legible photocopies of each page. Field books shall be scanned into a .pdf file and provided.

- Each field book shall have an index. The serial number and type of instruments used will be shown on this page.

- There is to be a maximum of one (1) horizontal setup per page.

e. Provide topographic survey in the form of a three-dimensional Micro Station graphics file, version 07.01, named **fh062530-v-sp.dgn**. The file shall contain breaklines, triangles, and spot elevations at their correct elevations and any other data required to create an accurate digital terrain model. Breaklines shall be placed at their actual elevation. Planimetric features shall be placed at zero elevation. Use the furnished file (AECvol1.pdf, Appendix A) showing level, color, line code, and weight (line symbology) convention for each graphics file. Working units shall be master units = feet, sub units = none. Resolution: 100 sub units per master unit, 10 positional units per sub unit. The government will provide a Micro Station seed file. (Use the attached Dining Facility survey file: fh023652D-V-spm1.dgn as a seed file) Only views one (1) and five (5) will be active. All locks will be off except keypoint snap and all displays will be on except text node and grid. Most map features constitute either graphics or text and are on separate levels. However, in some cases, text will be placed on the same level as the graphics. Examples of this would be the "S" embedded in the line for sanitary sewer or the "W" in the line for water. Font 1 shall be use for all text. Font 3 may be used where applicable.

f. Utility information. All utilities that are field tied shall be placed into the appropriate Micro Station graphics file, as stated above. This includes showing manholes, valves, power poles, etc., and connecting lines. Also the attribute information (text) for each utility shall be placed in the graphics file. This can include but not be limited to top of rim elevation, invert elevations, pipe size, direction, top of valve elevation, etc. All horizontal and vertical control established for ties shall be shown as a symbol with annotation.

- Map symbols. All symbols shall conform to the Government-furnished cell library (surv_sym.cel).

- For buildings or structures provide the type of structure, number of stories or floors, and building number if site is located on a military installation.

- Identify all surfaces, grass, ground cover, concrete, asphalt, etc. for all features including but not limited to roads, streets, driveways, sidewalks, parking areas, airfields, ditch linings, etc.

- Locate and identify the highway right-of-way/base boundary.

- Locate, identify, and describe all fences.

3. SPECIAL REQUIREMENTS:

There shall be no cutting of trees and brush cutting shall be kept to a minimum.

Excessive marking with paint, flagging, etc. will be avoided.

The Contractor shall comply with all applicable safety regulations of the current U.S. Army Corps of Engineers Safety and Health requirements manual EM 385-1-1, and shall acquaint himself and his personnel with the safety requirements governing the area in which the work is being done.

4. MATERIAL TO BE FURNISHED TO THE CONTRACTOR:

Utility maps as required for areas of work. Some of the existing utilities in the project areas are shown on the attached maps. These maps shall be used for reference only. Utility locations shall be field verified with surface features, etc. Additional utility maps can be obtained from the Ft. Hood Department of Public Works (DPW). The Contractor shall be responsible for contacting Ft. Hood DPW for these maps. The following maps are attached:

- *Storm Drainage*
- *Sanitary Sewer*
- *Water*
- *Electrical*
- *Gas*

Control points, benchmarks, and seed file information. Use the attached Dining Facility survey file, fh023652D-V-spm11.dgn for the seed file and for control points for this project.

Cell library (surv_sym.cel), and library legend (surv_legend.pdf).

Files and level/layer convention and symbology. See A/E/C CADD Standard (AECvol1.pdf), Appendix A, Surveying/Mapping (pages A8-A23) for level assignments and symbology requirements for the CADD files mentioned in item 2 above.

5. FINAL SUBMITTAL:

Final submittal shall consist of:

- *Micro Station graphics design files specified above of the survey delivered on 3 ½" floppy or CD-ROM.*
- *Plots of survey with spot elevations displayed and without spot elevations displayed at a 1" = 30' scale.*
- *All items in paragraph 2 above.*
- *All computations.*
- *Copies of all field notes / books (checked and reduced) scanned to .pdf files.*
- *All raw field data and final coordinate files.*
- *The government reserves a period of 10 days to review and comment on Contractor's work.*

6. REPORTS:

The contractor shall submit monthly progress status reports during the duration of the project.

EM 1110-1-1005
1 Jan 07

7. SCHEDULE AND DELIVERY:

The submission schedule shall commence on the day notice-to-proceed is issued and will run consecutively for the number of days shown in the attached schedule. A letter of transmittal shall accompany all submittals. The final submittal shall be submitted by close of business on 28 Sep 2004.

8. ACCESS TO THE PROJECT SITE: Contact Lisa Cuellar (Ft. Hood POC, 254-788-2756), at the Ft. Hood DPW office, upon notice-to-proceed to schedule access to the project sites.

9. FUNDING INFORMATION:

Work Item Number: To be provided

Mark L. Black, P.E.
Chief, Civil Section

Encl
Drawings of areas to be surveyed
Existing Utility Maps
AEC CADD Standards, Vol. 1
Cell Library and Legend
Control Point drawing
Copy furnished John Oblak, Engr. Manager
Micro Station Seed File

D-5. Technical Specifications for a Topographic Survey of a Scour Erosion Area (Tulsa District)

The following technical specifications are representative of a civil project where detailed topographic surveys are required in a scour area.

**CONTRACT NO. DACW56-01-1005
TASK ORDER NO. 0016
TOPOGRAPHIC SURVEY
PAT MAYES LAKE, TEXAS
SCOUR EROSION AREA ALONG SANDERS CREEK (NORTH OF DAM SITE)
08 JAN 03
Rev. 13 JAN 03**

SCOPE OF WORK

1. SCOPE AND LOCATION.

a. *The intended purpose of this Task order is to obtain a product defining the topography around the scour area of erosion as shown on Government furnished map. The contractor's effort toward this purpose shall yield total field-to-finish information packages, complete in detail and within the parameters defined by this scope of work, readily available for use by the Government or its agents.*

b. *The contents of this scope describe specific project requirements to be accomplished under this delivery order and the end product required of the contractor.*

2. MATERIALS FURNISHED BY THE GOVERNMENT.

The contractor shall be provided with:

a. *Site map indicating the areas to be surveyed.*

b. *Digital photos of the area to be surveyed.*

3. CHARACTER AND EXTENT.

The general scope of services required of the contractor is outlined below. Specific descriptions and technical requirements pertaining to the work will follow in subsequent sections.

4. SITE SPECIFICS

The site to be surveyed is located north of the Pat Mayse Lake Dam along Sanders Creek, approximately 1,500 north of the exit drain. The site to be surveyed extends from an area 100 feet southwest of the end of rip rap along Sanders Creek to approximately 350' northeast (or 100' northeast of the scoured area). In addition, locations are required from the fence line (on the west) to the toe of slope at the Wildlife Management Area (to the east).

5. FIELD SURVEYING

a. *Survey Control*

(1) Horizontal control shall be established on the Texas State Plane Coordinate System North Zone NAD 83 US Feet (site control may be established using CORS). Control shall be established to meet minimum requirements for 3rd Order, Class I, 1:10,000. Controlling points shall be occupied points of a closed and adjusted traverse that will meet or exceed Third order, Class I, Accuracy of 1:10,000. If more control points are required to be set during the execution of the survey, rebars may be set and should be planted to assure a degree of permanency. All control points set shall also be adequately described and referenced on the digital SWT 598 forms.

(2) Vertical control shall be referenced to the NGVD 29 U.S. Feet. (Date and Time Water Surface Locations can be used). Controlling points shall be established utilizing procedures to meet or exceed Third Order Accuracy Standards. All level lines shall be closed and vertical error adjusted throughout each level loop.

(3) New control stations shall consist of ½" Rebar having a length of 18" with a stamped aluminum cap. Each cap shall be identified by designation and the year set. Each control marker shall be referenced with at least three ties and appropriately described in hardbound field books for future use. Proper care shall be taken when setting any control points and at least a 2' radius around the control marker site shall be checked for the presence of any underground utilities.

b. Topographic survey

Topo shots sufficient to define 1' contour intervals shall be taken as well as spot elevations, all breaklines, dyke areas (top, centerline and toe elevations) and water depth locations (use of a small flat bottom boat will be required; the width of the area to be located by boat is approximately 50' by 150'). An invert elevation of the pipe (with pipe size and material) exiting the dam site shall be located. In addition, cross sections shall be taken at every 25' beginning at a location 50' south of the end of riprap along the Sanders Creek embankment and continuing approximately 50 feet north of the scour area. Cross section locations shall consist of 10' offset west of top of bank, top of bank (W), rock edge (W), toe of slope (W), edge of creek (W), centerline of creek (W), edge of creek (E), toe of slope (E), edge of rock (E), top of slope (E) and offset 10' east of top of bank. In addition, the Corps of Engineers boundary line and corners and fence line along the westerly line of the area in question shall be located. All State and Federal Laws pertaining to the surveying of government boundaries are to be followed in the preparation of this mapping. The contractor shall illustrate the following information on the title block: Project Name, County, State, Coordinate System used, contour interval, date of survey.

c. Survey Data and Deliverables

(1) The finished product shall be delivered in Bentley MicroStation CADD (*.dgn) and *.dtm format. Specifically, they shall be submitted as MicroStation 3D dgn files with working units resolution 1 to 100, Master Units: ', subunits <blank>, global origin GO = 21 474 836.48, 21 474 836.48, 21 474 836.48; furnish one CDROM one MicroStation 3D drawing file showing existing contours and any planimetric features with contours and features at correct elevations; one MicroStation 3D drawing file showing points and breaklines on separate levels and dtm created by or readable by Intergraph Inroads software. The supplied disks shall be clearly labeled to show contractors name and telephone number, map scale, date and file name.

(2) Corpsmet Metadata (FGDC format) file shall be delivered at the completion of the project.

(3) Digital SWT 598 forms (.dgn) shall be provided illustrating at least three reference ties and their general relationship to North and "to reach" descriptions for any new survey control set for the project.

(4) Any field notes, raw data collection files, plottings, etc. used in the execution of the survey work shall be provided.

6. ACCESS TO WORK.

The contractor shall be liable for and save the Government harmless on account of damages to persons or property in the performance of his work. The use of ATV or vehicles on any adjoining properties shall be prohibited, although they will be allowed on Government lands as long as discretion is used. The contractor shall contact the Pat Mayse Lake Office, Paul Gray, Lake Manager at (903) 732-3020 or Jeff Paskin, Park Ranger at (903) 732-3020.

7. SAFETY.

General Safety Requirements. The Contractor shall comply with applicable safety regulations defined in the latest version of the U.S. Army Corps of Engineers Safety and Health Requirements Manual EM 385-1-1, and shall acquaint himself and his personnel with the safety requirements governing the area in which the work is being done. Total man-hours worked by survey and office personnel shall be provided to the project manager at the completion of the project.

8. COMMENCEMENT OF WORK.

The contractor shall be prepared to begin the first full week after award of delivery order unless otherwise directed by the contracting officer.

9. TIME SCHEDULE.

The contractor performance and time of delivery are of utmost importance, and his endeavor toward the project shall be vigorous and continuous until completion. All work shall be completed and final delivery made to the Government within two weeks of execution of this task order.

10. INSPECTION.

The government may elect to perform independent field surveys in order to check and validate the accuracy and adequacy of the submitted data. The government reserves the right to reject inaccurate and substandard work. In the event such work is rejected, the contractor shall correct and replace rejected portions in a manner satisfactory and without cost to the government. The contractor shall coordinate his operations so as to permit direct contact with project manager purpose of inspection of work and general liaison.

11. PROJECT MANAGER.

The project manager for this survey mapping project will be Marjorie Courtright, Survey Section, 918-669-7574. All correspondence and information pertaining to the project will go through the project manager.

12. BILLING.

Payment requests shall be submitted to the A/E Contracts and Documents Section once each month. The request shall show a breakdown of all the related work tasks and percentage of work completed. Percent claimed will coincide with the progress report. The above should be mailed to:

*Tulsa District, Corps of Engineers
ATTN: Ginger Wilkins (CESWT-EC-Q)
1645 S. 101st E. Ave.
Tulsa, OK 74128-4629*

13. THE CONTRACTOR SHALL REFER TO APPLICABLE PORTIONS OF APPENDIX A FOR GENERAL AND TECHNICAL REQUIREMENTS NOT COVERED BY THIS SCOPE.

D-6. Jacksonville District Plane Table Topographic Survey Specifications (1989)

The following guidance is taken from a plane table specification developed by the Jacksonville District in the 1950s and 1960s, and last updated in 1989. Even though these criteria were developed around a plane table survey method, many of the general observation and detail requirements are still applicable to total station or RTK methods employed today. The accuracy specifications contained in this guidance are no longer applicable--see Chapter 4 for updated specifications. Other sections in this original document are not included--only Section 7 is excerpted below.

**TECHNICAL REQUIREMENTS FOR SURVEYING, MAPPING, AND PHOTOGRAMMETRIC
SERVICES
U S ARMY ENGINEER DISTRICT, JACKSONVILLE
ENGINEERING DIVISION -- SURVEY BRANCH
March 1989**

7. DETAILED SITE PLAN TOPOGRAPHIC MAPPING SURVEYS

7.1 General.

7.1.1 These surveys are required to, provide the information necessary for the planning, cost estimating, design, and relocation of structures in connection with construction responsibilities of the District. Surveys that fall within this category include, but are not limited to the following:

7.1.2 Civil projects, which include dam-sites, recreation areas, and the like, and may include strip topo for road or pipeline planning. Scales for civil projects may be 1"=20', 1"=50', 1"=100', or 1"=200', with possible variations in special cases.

7.1.3 Military projects, which cover Army and Air Force bases, ammunition plants, etc. Normal scale for detail planning is 1"=30' with 1' contours with variations in special cases.

7.1.4 These instructions are intended to be general since the individual assignment will vary as to contour interval, scale of the map, survey instrument (i.e. Plane Table, Radial, Total Station, Photogrammetric, etc) and detail necessary. Supplemental instructions will be issued for each job. The location of the site to be mapped and available control shall be furnished to the survey party.

7.2 Control.

7.2.1 The area to be mapped should be covered with a network of third order traverse. Good substantial semi-permanent points shall be set at each traverse station and located or described. At least two permanent markers shall be set and described on each site.

7.2.2 A level line of not less than third order should be run and elevations established as directed in the job instructions. Marks shall be established for use during construction as specified. Supplemental leveling by the use of alidade will not be permitted.

7.2.3 Field notes on both horizontal and vertical control will be submitted with other data for computing and final adjustment. Control points will be plotted on plane table sheets and symbolized as follows:

7.2.3.1 Monuments or disks in concrete by a triangle.

7.2.3.2 Hubs by a square.

7.2.3.3 Pipes, pins, or RR spikes by a circle.

7.2.3.4 Plastic hubs by a hexagon.

7.3 Plotting.

7.3.1 No rule can be laid down as to the number of elevations that should be determined from each plane table station for a given area. But rarely should shots be spaced greater than 1 inch on the plane table sheet. It will depend on the skill of the topographer and the configuration of the ground. Careless work is indicated when the contours vary from their true elevation by more than one-half the contour interval. Therefore, it stands to reason that a greater number of elevations are necessary for a 1- or 2- foot contour interval than are required for a larger contour interval. This is also true on a project that is to be mapped on a large scale.

7.3.2 Great emphasis should be placed on instruction and training of the rodman in a topographic party. He should be advised of job requirements in order to select points for "shots," as he is generally ranging far from the note keeper and is the only one in position to see details needed to complete map requirements.

7.3.3 A contour never splits, nor will they ever cross each other except in rare instances of an overhanging cliff, cave, or tunnel. When it is necessary to introduce an auxiliary contour, no more of it should be shown than is necessary to delineate the special feature which makes it necessary. A principle contour, on the other hand, should not have an end within the area to be mapped.

7.3.4 Index contours (multiples of 5 times interval shall be drawn heavier and labeled. Intermediate contours should be labeled when contours are not dense. On steep slopes the intermediate contours may be dropped, only the index being shown.

7.3.5 Special attention should be given to sheet edges. If necessary, a profile line of elevations should be run around the sheet edge to insure an unquestionable match to the adjoining sheet.

7.3.6 The purpose for which the survey is made will govern the amount of detail necessary. This will be covered in survey requirements for each job.

7.3.7 All culture will be shown by the use of symbols as adopted by these instructions. Should it become necessary for the topographer to use a symbol other than the standard topographic symbols, that symbol and the name of the feature it represents should be shown in a legend on the plane table sheet.

7.3.8 Topography notes are seldom used after a map is completed. However, questions sometimes arise when there is doubt as to the correctness of some points on the plane table sheets. When this occurs, it is necessary to refer to the field notes, and, for this reason, it is necessary to keep the topography notes.

7.3.9 *The names of all roads, bridges, street, bodies of water, and other such features will be shown. Building will be identified by name and type. Any feature that cannot be shown by symbol will be identified by notation.*

7.3.10 *Adjoining sheets should accurately match and should be visually checked in the field to insure that the drainage, culture, surface, and subsurface structures truly represent actual conditions.*

7.4 *Features to be shown.*

(NOTE: THESE FEATURES MUST BE DETAILED UNLESS SPECIFICALLY EXCLUDED WITHIN INDIVIDUAL PROJECT INSTRUCTIONS).

7.4.1 *Natural drainage:*

7.4.1.1 *Elevations in drains as necessary to control contours and alignments.*

7.4.1.2 *On larger streams, top bank, water's edge, and depth.*

7.4.2 *Lakes, ponds, springs, wells:*

7.4.2.1 *Name, if any.*

7.4.2.2 *Depth.*

7.4.3 *Swamps, sinkholes:*

7.4.4 *Rock outcrops, rock areas:*

7.4.5 *Vegetation:*

7.4.5.1 *Size and description, such as. "Dense hardwood, heavy underbrush" (size) "Scattered pines" (Size) "Pecan orchard" (Size).*

7.4.5.2 *Prominent trees should be symbolized separately, particularly on military bases and in recreation areas.*

7.4.5.3 *Description of open land, whether pasture, cultivated, etc. If cultivated, what crop?*

7.4.6 *Section or property lines:*

7.4.7 *Buildings and structures:*

7.4.7.1 *Type of construction (as "Frame", "brick", etc.).*

7.4.7.2 *Building usage and name (residence, barn, school, etc.)*

7.4.7.3 *Building number, if on military base.*

7.4.7.4 *Position of building should be established by chaining to corners if critical to planned construction.*

7.4.7.5 *Floor elevations to nearest 0.01 foot.*

7.4.7.6 *Location of doors, steps, etc.*

7.4.7.7 *Entry points of utilities and location of meters, switch boxes, etc. if outside.*

7.4.8 *Roads, streets, walks, etc:*

7.4.8.1 *Type of surface and condition.*

7.4.8.2 *Elevations at centerline, edges of pavement, shoulders or gutter, top of curb. Critical elevations on paved surfaces should be determined to nearest 0.01 foot.*

7.4.8.3 *Type of gutter or curb and gutter (A cross-section sketch is usually helpful.)*

7.4.8.4 *Right-of-way width and limits (if not on government property).*

7.4.8.5 *Name of road or street.*

7.4.8.6 *Bridges (See also Paragraph 12.7).*

7.4.8.6.1 *Type of structure.*

7.4.8.6.2 *Elevations of floor and handrail.*

7.4.8.6.3 *Low steel, when required.*

7.4.8.6.4 *Wingwall description.*

7.4.8.6.5 *Separate sketch when critical to planning.*

7.4.8.7 *Culverts.*

7.4.8.7.1 *Size and type of pipe or box.*

7.4.8.7.2 *Elevation, top and inverts at each end.*

7.4.8.7.3 *Wingwall.*

7.4.9 *Railroads:*

7.4.9.1 *Alignment.*

7.4.9.2 *Number of tracks.*

7.4.9.3 *Elevations, base and top of rail (to nearest 0.01 foot).*

7.4.9.4 *Turnouts and sidings.*

7.4.9.5 *Drainage structures, size and invert elevations.*

7.4.9.6 Weight of rail.

7.4.9.7 Width of right-of-way.

7.4.9.8 Operating company.

7.4.9.9 Size of ties (LxWxD) and center to center spacing.

7.4.9.10 Average depth of ballast below bottom of ties.

7.4.9.11 Typical cut and fill section.

7.4.9.12 Owner and description of utilities crossing railroad.

7.4.9.13 Curve data.

7.4.10 Water systems:

7.4.10.1 Pipe alignment, type, and size.

7.4.10.2 Invert of all pipes or tops of pipe elevation.

7.4.10.3 Location of fire hydrants and elevation.

7.4.10.4 Location of valves and elevation.

7.4.10.5 Storage tanks, elevation, and capacity.

7.4.11 Sanitary sewers.

7.4.11.1 Pipe alignment, type, and size.

7.4.11.2 Invert of all pipes or top of pipe elevations.

7.4.11.3 Manholes and all pipes, top and invert elevations.

7.4.11.4 Treatment plants in detail.

7.4.12 Storm sewers:

7.4.12.1 Alignment.

7.4.12.2 Pipe type and size.

7.4.12.3 Headwalls and end sections.

7.4.12.4 Manholes and all pipes, top and invert elevations.

7.4.12.5 Inlets, top and invert elevations, size of opening.

7.4.13 Fuel service:

7.4.13.1 Base lines, alignment and size.

7.4.13.2 Depth (elevation) of pipe.

7.4.13.3 Locations, sizes, and type of fuel in tanks.

7.4.14 Electrical power:

7.4.14.1 Sub-stations in detail.

7.4.14.2 Alignment of power lines.

7.4.14.3 Whether aerial or underground.

7.4.14.3.1 If underground, direct burial or duct.

7.4.14.3.2 Elevation.

7.4.14.4 Pole locations, approximate heights (elevation) and size, stamped nomenclature.

7.4.14.5 Size and type of conductors and voltage of system.

7.4.14.6 Location and size of transformers.

7.4.14.7 Location and type of manholes with elevations.

7.4.14.8 Operating company or agency.

7.4.14.9 Location of street lights.

7.4.14.10 Elevation of low wire at critical crossings (record atmospheric temperature time and date of observation.)

7.4.15 Telephone service:

7.4.15.1 Alignment.

7.4.15.2 Aerial or underground, direct burial or in duct, obtain top elevation.

7.4.15.3 Pole locations and heights, size, stamped nomenclature.

7.4.15.4 Manhole locations, type, elevation at top, and duct size.

7.4.15.5 Operating company or agency.

7.4.16 Heat distribution system:

7.4.16.1 Type of pipe if underground.

7.4.16.2 Alignment and elevations of distribution lines, size, pressure, or temperatures.

7.4.16.3 Locations and elevations of supports, anchors, manholes, traps, valves, expansion loops.

7.4.17 Fences:

7.4.17.1 Number of wires or type of fencing.

7.4.17.2 Height.

7.4.17.3 Kind of posts and spacing.

7.4.17.4 Location and size of gates.

7.4.17.5 Condition.

7.4.18 Runways, taxiways, aprons, etc:

7.4.18.1 Type of surface.

7.4.18.2 Dimensions.

7.4.18.3 Elevations to 0.01 foot at centerline and edges.

7.4.18.4 Positions of night lighting units and elevation at base.

7.4.18.5 Navigation aids and elevation of each.

7.4.18.6 Height of obstructions outside of area and ground elevation.

7.4.18.7 Service pits, etc.

7.4.19 North arrow:

7.4.19.1 Ten inches minimum length (on each sheet).

7.4.19.2 Type instrument.

7.4.19.3 Serial number.

7.5 Mapping Accuracy Requirements, Large Scale. Unless specified otherwise all mapping will meet the following horizontal and vertical accuracy requirements for scales of 10, 20, 30, 40, 50, 100, and 200 Feet to One Inch.

7.5.1 Contours: Ninety (90) percent of the elevations determined from the solid-line contours of the topographic maps shall have an accuracy with respect to true elevation of one-fourth (1/4) contour interval or better and the remaining ten (10) percent of such elevations shall not be in error by more than one-half (1/2) contour interval. In checking elevations taken from the map, the apparent vertical error may be decreased by assuming a horizontal displacement of one-fortieth (1/40) of an inch.

7.5.2 Coordinate Grid Lines: The plotted position of each plane coordinate grid shall not vary by more than one-hundredth (1/100) of an inch from true grid value on each map manuscript.

7.5.3 Horizontal Control: Each horizontal control point shall be plotted on the map manuscript within the coordinate grid in which it should lie to an accuracy of one-hundredth (1/100) of an inch of its true position as expressed by the coordinates computed for the point.

7.5.4 Planimetric Features: Ninety (90) Percent of all planimetric features which are well defined on the maps shall be plotted so that their position on the finished maps shall be accurate to within at least one-fortieth (1/40) of an inch of their true coordinate position, as determined by the test surveys, and none of the features tested shall be misplaced on the finished map by more than one-twentieth (1/20) of an inch from their true coordinate position.

7.5.5 Spot elevations: Ninety (90) percent of all spot elevations placed on the maps shall have an accuracy of at least one-tenth (1/10) the contour interval on natural ground and 0.01 foot for spot elevations on hard surfaces such as roads, sidewalks, sewers, pads, finished floors; etc.

7.6 Mapping Accuracy Requirements, Small Scale. Unless specified otherwise all mapping will meet the following horizontal and vertical accuracy requirements: scales of 400, 500, 800, and 1,000 Feet to One Inch.

7.6.1 Contours: Contours shall comply with the accuracy stipulations in 7.5.1.

7.6.2 Coordinate Grid Lines: The plotted position of each plane coordinate grid line shall not vary by more than one-eightieth (1/80) of an inch from true grid value on each map manuscript.

7.6.3 Horizontal Control: Each horizontal control point shall be plotted within the coordinate grid in which it should lie to an accuracy of one eightieth (1/80) of an inch of its true position as expressed by the coordinates computed for the point.

7.6.4 Planimetric Features: Ninety (90) percent of all planimetric map features shall be plotted so that their position on the finished maps shall be accurate to within at least one-thirtieth (1/30) of an inch of their true coordinate position, as determined by the test surveys, and none of the features tested shall be misplaced on the finished maps by more than one fifteenth (1/15) of an inch from their true coordinate position.

7.6.5 Spot Elevations: Spot elevations shall comply with stipulations in 7.5.5.

D-7. Typical State DOT Control and Topographic Survey Specification (Florida Department of Transportation)

GEODETIC CONTROL/HORIZONTAL ALIGNMENT

The CONSULTANT shall provide the DEPARTMENT with legible copies of all pertinent information utilized in making the field survey. All field survey data gathered will be furnished in a CAiCE readable format.

1. Establish geodetic baseline control on NAD 1983/1990 adjustment for the purpose of establishing horizontal control on the Florida State Plane Coordinate System. After the project network control has been processed and adjusted, the CONSULTANT will archive and forward to the District Surveying and Mapping Consultant Manager for review and approval. All data will be recorded in the CAiCE database.

NOTE: See Standards for FDOT GLOBAL POSITIONING SYSTEM SURVEY for HORIZONTAL NETWORKS (Amended December 21, 2000). You can obtain a copy from the Survey and Mapping Consultant Management department.

Primary Horizontal Control/GPS points shall be poured in place concrete monuments with brass disk set two inches below natural ground level at two to three mile intervals throughout the project. Secondary Horizontal Control points shall be iron rods and caps set at no more than two thousand foot intervals and will be inter-visible. Consultant may densify horizontal control as needed.

2. Using a total station and an electronic data collector with FDOT Electronic Field Book software, make all necessary Centerline, Subdivision, Lot, Block, and Right of Way ties necessary to reestablish the centerline of all of the dedicated right-of-way along the project as per furnished Right of Way maps.

3. Calculate the Centerline Alignment and Existing Right of Way lines for the main corridor and any dedicated connecting side roads. An alignment geometry chain, named "CL1", is to be created for the centerline of the main corridor, and each dedicated (by right of way maps) connecting side road will have a separate geometry chain named "SCL*". In addition, a separate geometry chain is to be created for every Right of Way line calculated. The alignment is to be approved in writing by the District Location Surveyor before any staking of the alignment begins. The preferred procedure for obtaining alignment approval is to generate a hard copy of proposed alignment showing comparisons with field versus existing Right of Way Map distances and curve information, along with stations and offsets to found monumentation. Schedule a time with the Survey Consultant Project Manager and District Location Surveyor to go over and discuss proposed alignment.

4. Stake and station the centerline alignment established for the main corridor and any dedicated (by right of way map) connecting side roads at even thousand (1000) foot stations including the beginning and ending of project stations and all P.C.'s, P.T.'s, and Non-Curve P.I.'s and at the intersection of state roads and any dedicated (by right of way maps) connecting side roads. All centerline points will be referenced (including the begin and end of survey), making sure that all references are outside of the right-of-way for the main corridor and all dedicated connecting side streets. All data will be recorded in the CAiCE database. Centerline alignments along dedicated side streets shall begin at the centerline of the main corridor and extend five hundred (500) feet beyond the existing or proposed right of way line of main corridor.

NOTE: On projects where there will be no right of way taking, the first reference should be set at the existing right of way line at 90 degrees to the baseline. These points should be copper coated iron rods and cap with a delineator post.

NOTE: All centerline reference points will be chained together and placed in zone 11 of the CAiCE database resulting in each centerline control point having one chain (called CLREF) describing its own references.*

NOTE: The consultant will be responsible for providing any incidental survey supplies, (i.e. control point disks, copper coated rods, Carsonite posts, etc.)

GPS STANDARDS--FDOT GLOBAL POSITIONING SYSTEM SURVEY STANDARDS FOR HORIZONTAL NETWORKS Amended December 21, 2000

I. EXISTING CONTROL

Every Global Positioning System (GPS) control survey will constrain to approved agency horizontal control points.

II. NETWORK DESIGN PLAN

Every GPS control project will have a Network Design Plan (NDP) submitted and approved by the District Location Surveyor (DLS) or his authorized representative. The NDP will consist of the following:

- A. The Layout of the Network Geometry.*
- B. Mission Plan*
- C. Identification of equipment to be used.*

NOTE: Equipment for all GPS work will be survey grade, carrier phase, geodetic receivers.

III. PRIMARY CONTROL STATION NAMING

Primary control station naming must adhere to the standard Department naming convention as described in the Location Survey Manual. The station names will be provided to the consultant by the District Location Surveyor or his representative.

IV. ADJUSTMENT

NOTE: All vectors referred to in this section are independent vectors.

- A. The final adjustment will be done with the latest Department approved network adjustment software.*
- B. The error estimates for constant error will be 0.005 meters and 5 PPM for proportional error.*
- C. All control will be held fixed, unless otherwise approved.*
- D. The final constrained adjustment will meet the following positional tolerances:*

NOTE: The value of the positional tolerance for a GPS station is its 95% confidence error ellipse semi-major axis derived from the constrained adjustment. To obtain this value the error ellipse semi-major axis derived from the least squares variance-covariance matrix is multiplied by the standard error of unit weight (a "scale" of data quality) and the F statistic multiplier (raises confidence from one sigma to 95% based on number of degrees of freedom). The test on the positional tolerance value is based on a constant and proportional error tolerance (usually 0.01 m. and 1/100,000 for primary FDOT networks). The proportional error is multiplied by the straight line distance to the nearest control point in the constrained adjustment. Therefore, using the stated tolerance values, an unknown point 1,000 meters from the nearest control point would have an allowable positional

*tolerance of 0.01 m. + (1/100,000) * 1000 m. = 0.02m. If this point's actual positional tolerance exceeds that value it has failed the positional tolerance test.*

	Constant error	Proportional error	Minimum # of horiz. control pts.	Minimum # of occupations for ea. point
Primary Control	0.010 (m)	1/100,000	3	2
Secondary Control	0.030 (m)	1/50,000	2	2
Other	0.050 (m)	1/30,000	2	2

V. GPS DELIVERABLES

NOTE: The GPS primary control survey must be submitted to and approved by the District Location Surveyor (DLS) or authorized representative in writing prior to finalizing secondary and other control surveys.

A. Primary Control Survey

- Final Network Design Plan in electronic or hard copy format.*
- ASCII activity log in electronic or hard copy format.*
- ASCII file containing raw vectors from proprietary software in electronic format.*

All adjusted data and computations from "Vector" software in electronic format. This includes all input files and output files for the minimally constrained adjustment and for the final constrained adjustment.

Items identified by the District Location Surveyor.

B. Secondary Control Survey

- ASCII file containing raw vectors from proprietary software in electronic format.*

All adjusted data and computations from "Vector" software in electronic format. This includes all input files and output files for the minimally constrained adjustment and for the final constrained adjustment.

Items identified by the District Location Surveyor.

C. Other Control Surveys

Items identified by the District Location Surveyor

Vertical Bench Line

The CONSULTANT shall provide the DEPARTMENT with legible copies of all pertinent information utilized in making the field survey. All field survey data gathered by use of electronic field book will be furnished in a CAiCE readable format.

Establish permanent Bench Marks poured-in-place concrete monuments and brass disc at one-mile intervals. Provide the Consultant Project Management Department with to reach forms for all permanent Bench Marks set. A series of secondary Bench Marks shall be set throughout the project at approximately one thousand (1,000) foot intervals and outside the anticipated limits of construction. Using a level and an electronic data collector with FDOT Electronic Field Book software, employ the three (3) wire method of running from an established bench mark (NAVD 88 unless approved otherwise) through the job bench marks to another established bench mark to obtain the adjusted elevation for the job bench marks. Provide to the Consultant Project Management Department a hard copy of the Bench Mark table to include name, elevation, (the elevation datum used must be clearly identified), station &

offset and description for each Bench Mark. All data (including vertical datum and a copy of the bench mark table) will be recorded in the CAiCE database and called "BM.Rpt".

NOTE: The consultant will be responsible for providing any incidental survey supplies, (i.e. control point disks, copper coated rods, Carsonite posts, etc.)

Topographic/DTM Survey

The CONSULTANT shall provide the DEPARTMENT with legible copies of all pertinent information utilized in making the field survey. All field survey data shall be gathered by use of electronic field book and will be furnished in a CAiCE readable format.

1. Using a total station and an electronic data collector with the FDOT Electronic Field Book Software, locate all topography (buildings, mail boxes, driveways, sidewalks, fences, signs, street light poles, utilities, pavement, pavement markings, pavement joints, traffic signals, curbing, curb cuts, ADA ramps, structures, ornamental trees, shrubs, tree lines, etc.) to ten (10) feet outside the existing right of way lines or thirty (30) feet outside the proposed right-of-way lines, if applicable. When right of way is being acquired, locate all improvements on commercial use properties, even if such improvements are outside thirty (30) feet from the proposed taking.
2. Using a total station and electronic data collector with the FDOT Electronic Field Book software, collect sufficient data to generate a Digital Terrain Model (DTM) to ten (10) feet outside the existing right of way lines or thirty (30) feet outside the proposed right of way lines, if applicable.
3. Take independent cross-sections at a maximum of one thousand (1,000) foot intervals to verify the Digital Terrain Model (DTM). These check sections should be recorded manually in a field book furnished by the DEPARTMENT. Under no circumstances are these check sections to be incorporated into the DTM.
4. Locate all above ground evidence of utilities (signs, pedestals, manholes, valve covers, etc.) and add to the CAiCE database.
5. Locate and obtain invert elevations on all pipes (side drains, cross drains, force mains, storm/sanitary, etc.) within the limits of the project. NOTE: In all cases when a manhole falls outside these limits but is needed to determine grade and location of a pipe within these limits, the manhole should be located and inverts obtained.
6. Make complete side street and road surveys to include topography and DTM for one hundred (100) feet beyond the mainline existing or proposed right of way line and to 10 feet beyond the side streets existing right-of-way lines. For side streets dedicated by right of way maps, this survey shall extend three (300) feet beyond the mainline existing or proposed right of way line.

Underground Utility Survey

The CONSULTANT will provide all services required for obtaining subsurface utility facilities including designating, locating and surveying.

Definitions: The term "designate" in this Scope of Services shall mean to indicate, by marking, the presence and approximate horizontal depth of all existing subsurface utilities using standard geophysical prospecting techniques. The CONSULTANT does not guarantee the accuracy of such designations as substitutions for as-built information obtained during any demolition, excavation, or construction activities. The term "locate" shall mean to obtain an accurate position (horizontal and vertical) of subsurface utilities by excavating a test hole and recording the position by survey methods.

Control and Alignment Survey:

Provide all the survey services to recover and/or reestablish the existing centerline and/or baseline for State Road XXX and any connecting side roads. Also recover and/or reestablish the existing horizontal and vertical control, as needed, throughout the limits of the project. Note: The CONSULTANT may densify the horizontal and vertical control if necessary. All data shall be recorded in the CAiCE database.

Subsurface Utility Designation: The subsurface utility designation services will include, but not be limited to, the following:

Obtain all necessary permits from city, county, municipality or other jurisdiction to allow the CONSULTANT to work in existing streets, roads, and other locations necessary for marking, measuring and recording the location of the existing utilities. Coordinate with utility agencies/owners.

Secure all utility as-built plans, plats, and other data as necessary to help designate the utilities. All plans, plats or other data in hard copy or electronic files containing utility information will be delivered to the DEPARTMENT.

Provide all traffic control within the work area while locating the subsurface utilities. Traffic control shall be maintained in accordance with DEPARTMENT policy and MUTCD and/or Roadway and Traffic Design Standards (Index 600). Provide all safety devices, signs and other safety equipment, including flagging personnel.

Designate and mark the horizontal location of each existing underground utility and their major laterals to existing buildings using a method pre-approved by the Department's Project Manager. The designation of the subsurface utility must be as close as possible to the true location of the existing utility.

Using a total station and an electronic data collector with the FDOT Electronic Field Book (EFB) Software, locate the designated utilities and add this information to the existing CAiCE database in the following manner:

All shots taken to measure the location of the designated utility are to be recorded in "ZONE 6" of the CAiCE database with a "U" attribute. The shots taken are to be on the surface of the ground or pavement above the utility and the surface shot should be good for elevation. A statement is to be placed in the description of each shot stating where the shot was taken (i.e., ground shot over gas line, pavement shot over a waterline, etc.). A chain is to be created and stored in "ZONE 6" of the CAiCE database with a "U" attribute, for each utility located. This chain is to be stored in the same direction as the baseline and/or centerline of survey that is in the existing CAiCE database. A statement is to be placed in the comments of each chain stating the owner of the utility. In addition, the description field of the chain shall state the type of the utility (i.e., gas, fiber optic, TV cable, etc.).

A station-offset report called "DESNATE.REP" is to be created and stored in the CAiCE database showing the station and offset to each utility chain designated.

Subsurface Utility Location (VVH): The subsurface utility location service will include, but not be limited to, the following:

Obtain all necessary permits from city, county, municipality or other jurisdiction to allow the CONSULTANT to work in existing streets, roads, and other locations necessary for the purpose of excavating, measuring and recording the location and depth of the existing utilities. Coordinate with utility agencies/owners.

Secure all utility as-built plans, plats, and other data necessary to help in locating and identifying the utilities. All plans, plats or other data in hard copy or electronic files containing utility information will be delivered to the DEPARTMENT.

Provide all traffic control within the work area while locating the subsurface utilities. Traffic control shall be maintained in accordance with DEPARTMENT policy and MUTCD and/or Roadway and

Traffic Design Standards (Index 600). Provide all safety devices, signs and other safety equipment, including flagging personnel.

Neatly cut and remove existing pavement or other material (not to exceed two hundred twenty-five (225) square inches per cut). Excavate the material in such a manner as to prevent any damage to wrappings, coatings or other protective coverings of the utility (i.e., vacuum/pressure excavations, hand digging, etc.).

Backfill and compact with select material around the utility. Provide a restoration of the surface pavement, within the limits of the cut, at the time of the backfill. In the event the excavation is in an area other than roadway pavements, the disturbed area will be restored to the condition before the excavation.

Furnish and install color-coded permanent above ground markers (i.e., PK nails, steel rods, etc.), on the surface directly above the centerline of the utility being located.

Provide complete clean up of work sites to equal or better conditions that existed before excavation began and close out all existing permits as required.

For each test hole location, complete and provide to the DEPARTMENT a "Subsurface Utility Form". The format of the form is to be pre-approved by the DEPARTMENT before Submittal.

Using a total station and an electronic data collector with the FDOT Electronic Field Book (EFB) Software, locate the utility both horizontally and vertically where test hole locations have been performed and add the information to the existing CAiCE database in the following manner:

All shots taken to measure the location of the utility at a test hole location are to be called VVH and have a Feature Code of a "CSH" meaning Core Sample Hole. These VVH* points are to be recorded in ZONE 6 of the CAiCE database with a "U" attribute. The elevation on the shot should be taken on top of the utility. In the description field of each shot describe the size, utility type, material type (i.e., 6" PVC water line, fiber optic in 2" metal conduit, 100 pair Southern Bell direct buried, etc.), below surface depth of the utility and place the initials VVH, meaning verified vertical and horizontal.*

A station-offset report called "LOCATE.REP" is to be generated and stored in the CAiCE database for each utility test hole location.

D-8. Guide Specification for Developing a Topographic Surveying Indefinite Delivery Contract

INSTRUCTIONS

1. General. This guide specification is intended for use in preparing Architect-Engineer (A-E) Indefinite Delivery Contracts (IDC) for professional surveying and mapping services. These specifications are applicable to all surveying and mapping contracts used to support USACE civil works and military design and construction, operations, maintenance, regulatory, and real estate activities. This guide is primarily for use in establishing procedures and specifications obtained through contracts under Public Law (PL) 92-582 (Brooks A-E Act) qualification-based selection procedures and for which unit prices in the contract schedule are negotiated.

2. Coverage. This guide specification contains technical standards and/or references necessary to specify the more common phases of a topographic and planimetric feature detail mapping project performed by conventional methods.

3. Applicability. The following types of A-E contract actions are supported by these instructions:

- Fixed-price service contracts.
- Indefinite delivery contracts.
- A multi-discipline surveying and mapping IDC contract in which topographic mapping services are a line item supporting other surveying, mapping, hydrographic, and photogrammetric services.
- A work order or delivery order placed against an IDC contract.
- Design and design-construct contracts that include incidental surveying and mapping services (including Title II services). Both fixed-price and IDC design contracts are supported by these instructions.

4. General Guide Use. This guide is primarily intended for field-to-finish topographic and planimetric feature detail survey contracts for large-scale site plan mapping to support engineering design for civil works and military construction projects. The final mapping product with supporting data should be completely suitable for use as a medium to support design and development of contract construction plans and specifications. Specifying field-to-finish implies that all phases of the mapping process, from establishing control, field acquisition, compilation, and delivery of the final compiled product will be performed by the contractor in which the contractor is responsible for complete quality control over all phases of the work. In adapting this guide to any project, specific requirements will be modified as necessary for the work contemplated. Changes will be made by deletions or insertions within this format.

5. Insertion of Technical Specifications. This manual (EM 1110-1-1005) should be attached to and made part of any service contract for mapping services. This manual contains specifications and quality control criteria for field-to-finish execution of a mapping project. Technical specifications for other survey functions required in a surveying and mapping services contract should be developed from other guide specifications applicable to the discipline(s) required. Standards and other specifications should be checked for obsolescence and for dates of applicability of amendments and revisions issued subsequent to the publication of this specification. Maximum use should be made of existing EMs, Technical Manuals, and other recognized industry standards and specifications.

7. Alternate Clauses/Provisions or Options. In order to distinguish between required clauses and optional clauses, required clauses are generally shown in capital letters. Optional or selective clauses, such as would be used in a work order, are generally in lower case.

8. Notes and Comments. General comments and instructions used in this guide are contained in asterisk blocks. These comments and instructions should be removed from the final contract.

9. IDC Contracts and Individual Work Order Assignments. Contract clauses which pertain to IDC contracts, or task orders thereto, are generally indicated by notes adjacent to the provision. These clauses should be deleted for fixed-price contracts. In general, sections dealing with IDC contracts are supplemented with appropriate comments pertaining to their use. Work orders against a basic IDC contract may be constructed using the format contained in Section C of this guide. Clauses in the basic contract should not need to be repeated in work orders. Contract section C is applicable to any type of surveying and mapping service contracting action.

**THE CONTRACT SCHEDULE
SECTION A
SOLICITATION/CONTRACT FORM**

NOTE: Include here SF 252 in accordance with the instructions in EFARS.

SF 252 -- (Block 5): PROJECT TITLE AND LOCATION

NOTE: Sample title for fixed-price contract

TOPOGRAPHIC AND PLANIMETRIC DETAIL SURVEYS IN SUPPORT OF SITE PLAN DEVELOPMENT FOR PRELIMINARY CONCEPT DESIGN OF ENGINEERING INSTALLATION FACILITY, _____ AFB, TEXAS. TOPOGRAPHIC MAPPING SERVICES CHANNEL IMPROVEMENT, LOCAL FLOOD PROTECTION PROJECT _____ WASHINGTON.

NOTE: Sample title for indefinite delivery type contract.

INDEFINITE DELIVERY CONTRACT FOR PROFESSIONAL SURVEYING AND MAPPING AND RELATED SERVICES IN SUPPORT OF VARIOUS *[CIVIL WORKS] [MILITARY CONSTRUCTION] PROJECTS *[IN] [ASSIGNED TO] THE _____ DISTRICT.

**SECTION B
SERVICES AND PRICES/COSTS**

NOTE: The fee schedule for topographic mapping and related survey services should be developed in conjunction with the preparation of the independent government estimate (IGE) along with the technical specifications.

**SECTION C
STATEMENT OF WORK**

C.1 GENERAL. THE CONTRACTOR, OPERATING AS AN INDEPENDENT CONTRACTOR AND NOT AS AN AGENT OF THE GOVERNMENT, SHALL PROVIDE ALL LABOR, MATERIAL, AND EQUIPMENT NECESSARY TO PERFORM THE PROFESSIONAL SURVEYING AND MAPPING AND *[RELATED SERVICES] *[FROM TIME TO TIME] DURING THE PERIOD OF SERVICE AS STATED IN SECTION D, IN CONNECTION WITH PERFORMANCE OF TOPOGRAPHIC SURVEYS AND THE PREPARATION OF SUCH MAPS AS MAY BE REQUIRED FOR *[ADVANCE PLANNING] [DESIGN] [AND CONSTRUCTION] [or other function] ON [VARIOUS PROJECTS] [specify project(s)]. THE CONTRACTOR SHALL FURNISH THE REQUIRED PERSONNEL, EQUIPMENT, INSTRUMENTATION, AND TRANSPORTATION AS NECESSARY TO ACCOMPLISH ALL REQUIRED SERVICES AND FURNISH TO THE GOVERNMENT DETAILED MAPS, PLATS, DIGITAL TERRAIN DATA, UTILITY DETAIL SHEETS, CONTROL DATA FORMS, REPORTS, AND OTHER DATA WITH SUPPORTING MATERIAL DEVELOPED DURING THE FIELD DATA ACQUISITION AND COMPILATION PROCESS. DURING THE PROSECUTION OF THE WORK, THE CONTRACTOR SHALL PROVIDE ADEQUATE PROFESSIONAL SUPERVISION AND QUALITY CONTROL TO ASSURE THE ACCURACY, QUALITY, COMPLETENESS, AND PROGRESS OF THE WORK.

NOTE: The above clause is intended for use in an IDC contract for topographic and planimetric mapping services. It may be used for fixed-price service contracts by deleting appropriate IDC language and adding the specific project survey required. This clause is not repeated on individual delivery orders.

C.2 LOCATION OF WORK.

NOTE: Use the following clause for a fixed-scope contract of individual work order.

C.2.1. TOPOGRAPHIC MAPPING AND RELATED SURVEYING SERVICES WILL BE PERFORMED AT [_____] *[list project area, installation, etc.]. *[A MAP EXHIBIT DEFINING THE SITE LOCATION AND PROJECT AREA IS ATTACHED AT SECTION G OF THIS CONTRACT.]

NOTE: Use the following when specifying an indefinite delivery contract for topographic mapping services.

C.2.2 TOPOGRAPHIC MAPPING AND RELATED SURVEYING SERVICES WILL BE PERFORMED IN CONNECTION WITH PROJECTS *[LOCATED IN] [ASSIGNED TO] THE [_____] DISTRICT. *[THE _____] DISTRICT INCLUDES THE GEOGRAPHICAL REGIONS WITHIN *[AND COASTAL WATERS] [AND RIVER SYSTEMS] ADJACENT TO:]

*[list states, regions, etc.]

NOTE: Note also any local points-of-contact, right-of-entry requirements, clearing restrictions, installation security requirements, etc.

C.3 TECHNICAL CRITERIA AND STANDARDS. THE FOLLOWING STANDARDS ARE REFERENCED IN THIS GUIDE. STATE OR LOCAL CODES MAY HAVE PRIORITY.

C.3.1 USACE EM 1110-1-1005. THIS REFERENCE IS ATTACHED TO AND MADE PART OF THIS CONTRACT. (SEE SECTION G.)

C.3.2 USACE EM 1110-1-1002, SURVEY MARKERS AND MONUMENTATION. *[THIS REFERENCE IS ATTACHED TO AND MADE PART OF THIS CONTRACT (SEE SECTION G)]

C.3.3. A/E/C CADD STANDARDS

C.3.3. *[District Drafting Standards, sheet sizes, types, formats, etc.].

C.3.4. *[Other applicable references, appendices].

Note: List other reference standards that may be applicable to some phase of the work such as other Engineer Manuals or standard criteria documents. Such documents need not be attached to the Contract; if attached, however, reference should be made to their placement in contract Section G.

C.4 WORK TO BE PERFORMED. PROFESSIONAL SURVEYING AND MAPPING AND RELATED SERVICES TO BE PERFORMED UNDER THIS CONTRACT ARE DEFINED BELOW. UNLESS OTHERWISE INDICATED IN THIS CONTRACT *[OR IN DELIVERY ORDERS THERETO], EACH REQUIRED SERVICE SHALL INCLUDE FIELD-TO-FINISH EFFORT. ALL MAPPING WORK WILL BE PERFORMED USING APPROPRIATE INSTRUMENTATION AND PROCEDURES FOR ESTABLISHING CONTROL, FIELD DATA ACQUISITION, AND COMPILATION IN ACCORDANCE WITH THE FUNCTIONAL ACCURACY REQUIREMENTS TO INCLUDE ALL QUALITY CONTROL ASSOCIATED WITH THESE FUNCTIONS. THE WORK WILL BE ACCOMPLISHED IN STRICT ACCORDANCE WITH SURVEYING AND MAPPING CRITERIA CONTAINED IN THE TECHNICAL REFERENCES (PARAGRAPH C.3 ABOVE), EXCEPT AS MODIFIED OR AMPLIFIED HEREIN.

NOTE: The following clauses in this section of the guide may be used for either fixed-price surveying and mapping contracts, IDC work orders under an IDC contract, or IDC contracts where surveying and mapping services are part of a schedule of various survey disciplines.

C.4.1. PURPOSE OF WORK. THE WORK TO BE PERFORMED UNDER THIS CONTRACT IS TO BE USED AS BASIC SITE PLAN MAPPING INFORMATION TO SUPPORT *[BE INCORPORATED INTO] [INSTALLATION/BASE COMPREHENSIVE MASTER PLANNING] [ENGINEERING DESIGN] [CONSTRUCTION] [OPERATION] [MAINTENANCE] [REAL ESTATE] [REGULATORY] [HAZARDOUS AND TOXIC WASTE SITE]; INCLUDING ALL RELATED ACTIVITIES.

NOTE: A description of the functional purpose of the mapping product should be stated in order for the contractor to focus his efforts and quality control toward the more critical aspects of the project. The above clause should fully define the intended use of the mapping product to be furnished by the contractor.

C.4.2. GENERAL SURVEYING AND MAPPING REQUIREMENTS. TOPOGRAPHIC AND PLANIMETRIC FEATURE DETAIL MAPS SHALL BE COMPILED AT A TARGET SCALE OF 1 IN. = [] FT FOR THE SITE DELINEATED ON EXHIBIT ATTACHED AT SECTION G. THE MAPPING AND/OR RELATED DIGITAL PRODUCTS SHALL MEET OR EXCEED USACE (ASPRS) CLASS *[] ACCURACY STANDARDS AS SPECIFIED IN EM 1110-1-1005. PLANIMETRIC FEATURE DETAIL WILL BE COMPILED IN ACCORDANCE WITH THE HORIZONTAL ACCURACY STANDARDS SET FOR THIS CLASS. CONTOURS SHALL BE DEVELOPED AT [] - FT INTERVALS IN ACCORDANCE WITH THE VERTICAL ACCURACY STANDARDS SET FOR THIS CLASS. FEATURE AND TERRAIN DATA SHALL BE DELIVERED IN *[HARD COPY AND] DIGITAL FORMAT.

NOTE: The above clause should be used for fixed-scope contracts of IDC contract work orders to give an overview of the general mapping effort. Technical requirements will be described in subsequent paragraphs. Note that the final map compilation target scale and ASPRS Accuracy Class/Standard is defined upfront in the scope of work. IDC contracts and work orders: Since specific project scopes are indefinite at the time a basic contract is prepared, only general technical criteria and standards can be outlined. Project of site-specific criteria will be contained in each delivery order along with any deviations from the technical standards identified in the basic IDC contract. The clauses contained within the remainder of the contract are used to develop general requirements for a basic IDC contract. Subsequent delivery orders will reference these clauses, adding project-specific work requirements as required. Delivery order formats should follow the outline established for the basic IDC contract.

C.4.3. FIELD PROCEDURES AND REQUIREMENTS. APPROPRIATE INSTRUMENTATION AND PROCEDURES, CONSISTENT WITH ACCEPTED PROFESSIONAL SURVEYING AND MAPPING INDUSTRY STANDARDS AND PRACTICE, SHALL BE SELECTED TO ACHIEVE THE ACCURACY STANDARDS REQUIRED. THE CONTRACTOR SHALL FIELD A FULLY EQUIPPED SURVEY CREW(S), CONSISTING OF PROFESSIONAL SURVEY PERSONNEL, EXPERIENCED IN PERFORMING THE REQUIRED SURVEYS AND CAPABLE OF COMPLETING THE WORK WITHIN ALLOTTED SCHEDULES. ALL FIELD OBSERVATIONAL DATA REQUIRED TO SET AND ESTABLISH PROJECT CONTROL SHALL BE RECORDED IN STANDARD PERMANENT BOUND FIELD BOOKS WHICH WILL SUBSEQUENTLY BE DELIVERED TO THE GOVERNMENT. ALL SURVEY WORK SHALL BE PERFORMED UNDER ADEQUATE SUPERVISION AND QUALITY CONTROL MEASURES. *[ALL SURVEY WORK, INCLUDING OFFICE COMPUTATIONS AND ADJUSTMENTS, IS SUBJECT TO GOVERNMENT REVIEW AND APPROVAL FOR CONFORMANCE WITH PRESCRIBED ACCURACY STANDARDS. DEFICIENCIES WILL BE RECOGNIZED AND STEPS TO INITIATE CORRECTIVE ACTIONS SHALL BE TAKEN AS REQUIRED]. *[THE CONTRACTOR SHALL ALLOW DIRECT CONTACT WITH RESPONSIBLE-IN-CHARGE PERSONNEL FOR EACH PHASE OF THE WORK FOR PURPOSES OF PROGRESS ESTIMATES AND COMPLIANCE WITH THE CONTRACT REQUIREMENTS].

C.4.3.1. HORIZONTAL CONTROL SHALL REFERENCE EXISTING PROJECT AREA CONTROL. CONTROLLING POINTS SHALL BE OCCUPIED AS A STATION WITHIN A CLOSED TRAVERSE THAT WILL MEET OR EXCEED *[THIRD] []- ORDER, *[CLASS*[]] [] RELATIVE ACCURACY CLASSIFICATION *[OR 1 PART IN 10,000] [] AS ESTABLISHED FOR ASPRS CLASS *[] MAPPING STANDARDS. THE TRAVERSE SHALL INITIATE AND CLOSE UPON ACCEPTABLE CONTROL MONUMENTATION USED TO ESTABLISH THE EXISTING PROJECT GRID SYSTEM. ALL GRID COORDINATES SHOWN ON THE MAP PRODUCTS SHALL BE EXPRESSED IN OR CONVERTED TO, *[US SURVEY FEET] [INTERNATIONAL FEET] [METERS]. COORDINATES SHALL BE REFERENCED TO THE LOCAL *[SPCS 27] [SPCS 83] [UTM ZONE].

C.4.3.2. VERTICAL CONTROL SHALL BE REFERENCED TO *[NGVD 29][NAVD 88]. CONTROLLING POINTS SHALL BE ESTABLISHED WITHIN A CLOSED LEVEL LOOP THAT WILL MEET OR EXCEED *[THIRD] []-ORDER,

ACCURACY STANDARDS AS ESTABLISHED FOR ASPRS CLASS *[]] MAPPING STANDARDS. ELEVATIONS SHALL ORIGINATE AND CLOSE ON ACCEPTABLE BENCHMARKS IN THE PROJECT AREA.

NOTE: Few USACE surveying and mapping projects require relative accuracy classifications in excess of Third Order, Class I, 1:10,000 for horizontal control and Third Order 1:5,000 for vertical control. Although instrumentation, conventional and GPS, are capable of achieving higher accuracy requirements, specifying higher levels of accuracy may adversely impact the overall project cost and should be thoroughly justified relative to the required mapping accuracies and other factors.

C.4.3.3. EXISTING PROJECT/NETWORK CONTROL. A TABULATION AND/OR DESCRIPTION OF EXISTING PROJECT/NETWORK CONTROL POINTS *[IS SHOWN BELOW] [IS SHOWN IN ATTACHMENT] [WILL BE PROVIDED IN THE DELIVERY ORDER]. THE SOURCE AGENCY, COORDINATES, DATUM, AND ESTIMATED ACCURACY OF EACH POINT ARE INDICATED. PRIOR TO USING ANY CONTROL POINTS, THE MONUMENTS SHOULD BE CHECKED TO ENSURE THAT THEY HAVE NOT BEEN MOVED OR DISTURBED.

NOTE: List existing control station(s) or, alternately, refer to a map exhibit, tabulation attachment, and/or descriptions that would be included in an attachment.

a. *The contractor shall perform the necessary surveys to connect existing project control to assure that such control has sufficient relative accuracy to adequately control the overall project. Should these surveys indicate deficiencies in the existing control, the contractor shall advise the Contracting Officer *[or Contracting Officer Representative]. The contractor shall furnish the appropriate data indicating a deficiency. If the Contracting Officer *[or Contracting Officer Representative] deems it necessary to perform resurveys of the existing network, appropriate modification may be made to the contract.

b. *Suitable control monumentation shall be set as required to adequately control construction phases. All stations shall be monumented in accordance with EM 1110-1-1002, Survey Markers and Monumentation. Monumentation for this project shall be Type *[] for horizontal and Type *[] for vertical, per EM 1110-1-1002 criteria. *[Monumentation shall be defined to include the required reference marks and azimuth marks required by EM 1110-1-1002.]

NOTE: Deviations from EM 1110-1-1002 should be indicated as required. USACE project control rarely requires supplemental reference/azimuth marks - the optional specification clauses below should be tailored accordingly.

c. *At each station, angle and distance measurements shall be made between a network station and reference/azimuth marks established in accordance with the requirements set forth in EM 1110-1-1002. All observations shall be recorded in a standard bound field book or comparable electronic notebook.

(1) *For reference marks, two (2) directional positions are required (reject limit + 10-second arc) and with steel taping performed to the nearest + 0.01 ft.

(2) *Four directional positions are required for azimuth marks. The reject limit for a 1-second theodolite is + 5 seconds. Azimuth mark landmarks shall be easily defined/described natural features or structures of sufficient distance to maintain a *[]-second angular accuracy. *[]-order astronomic azimuths shall be observed to azimuth marks.]

(3) *A compass reading shall be taken at each station to reference monuments and azimuth marks.

C.4.3.4. STATION DESCRIPTION AND RECOVERY REQUIREMENTS.

a. *Station descriptions and/or recovery notes shall be written in accordance with the instructions contained in EM 1110-1-1002. *[Form [] shall be used for these descriptions.] Descriptions shall be *[written] [typed].

b. *Descriptions *[are] [are not] required for *[existing] [and/or newly established] stations.

c. *Recovery notes *[are] [are not] required for existing stations.

d. *A project control sketch *[is] [is not] required.

C.4.4. FIELD CLASSIFICATION AND MAP CHECK SURVEYS. FIELD CLASSIFICATION, INSPECTION, AND/OR CHECK/MAP ACCURACY TEST SURVEYS *[WILL] [WILL NOT] BE PERFORMED *[ON THIS PROJECT].

NOTE: Tests for compliance of a map sheet are optional. Check points are based on "well-defined points" established in a manner agreed upon by the contracting parties. Criteria for testing for map accuracy compliance are defined in the ASPRS Accuracy Standards for Large-Scale Maps.

C.5. MAP COMPILATION, DRAFTING, AND CADD SPECIFICATIONS.

C.5.1. MAP COMPILATION SCALE. THE CONTRACTOR SHALL FURNISH *[REPRODUCIBLE] FINISHED MAPS AT A SCALE OF 1 IN. = *[] FT. THE MAP MEDIA SHALL BE COMPUTER-GENERATED PLOTS ON *[PAPER] [HIGH-GRADE, STABLE BASE MYLAR NOT LESS THAN *[] IN. IN THICKNESS] *[E] [] - SIZE SHEETS].

C.5.2 TOPOGRAPHIC AND PLANIMETRIC FEATURES. THE MAPS SHALL CONTAIN ALL TOPOGRAPHIC AND PLANIMETRIC FEATURES ENCOUNTERED WITHIN THE PROJECT LIMITS. THE MAPS SHALL PROPERLY DEPICT THE EXISTING SITE CONDITIONS AS NECESSARY FOR THE PROPER USE OF THEIR INTENDED PURPOSE. THE FINAL MAPPING PRODUCT GENERATED BY THE CONTRACTOR SHALL COMPLY WITH AND CONTAIN BUT NOT BE LIMITED TO THE FOLLOWING:

a. TERRAIN FEATURES/CONTOUR DEVELOPMENT. *[THE CONTOUR INTERVAL FOR THIS PROJECT IS FT.]. CONTOURS SHALL BE LEGIBLE AND DRAWN SHARP AND CLEAR AS SOLID LINES. EVERY *[FIFTH] [] CONTOUR (INDEX CONTOUR) SHALL BE ACCENTUATED AS A HEAVIER LINE THAN THE INTERMEDIATE FOUR. HALF-INTERVAL OR [] FT. SUPPLEMENTAL CONTOURS SHALL BE ADDED AS DESIGNATED. LABELING OR NUMBERING OF CONTOURS SHALL BE PLACED SO THE ELEVATIONS ARE READILY DISCERNIBLE. LABELING OF INTERMEDIATE CONTOURS MAY BE REQUIRED IN AREAS OF LOW RELIEF.

(1) TURNING POINTS THAT DEFINE DRAINAGE CHANNELS, DITCHES, ETC., SHALL BE CONSISTENT IN DEPICTING CORRECT ALIGNMENT AND DIRECTION OF DRAINAGE.

(2) SPOT ELEVATIONS SHALL BE ESTABLISHED AND SHOWN ON THE MAPS AT WATER SURFACES ON SHORELINES OF LAKES, RESERVOIRS, PONDS, AND THE LIKE; HIGH AND LOW POINTS AT HILLTOPS AND DEPRESSIONS; AT INTERSECTIONS AND ALONG CENTER LINES OF STREETS AND, WHERE APPLICABLE, TOP CURB AND GUTTER; AT TOPS AND BOTTOMS OF VERTICAL WALLS AND OTHER STRUCTURES; AND AT CENTER LINE OF END OF BRIDGES. GROUND SPOT ELEVATIONS SHALL SUFFICIENTLY SUPPLEMENT CONTOURED ELEVATIONS AND SHALL NOT EXCEED *[] IN. AT TARGET SCALE. SPOT ELEVATIONS SHOWN ON THE MAP SHEETS SHALL BE ACCURATE TO [] DESIGNATED CONTOUR INTERVAL.

(3) DIGITAL TERRAIN MODEL (DTM) GENERATION. DIGITAL ELEVATION MODELS (DEM) SHALL BE GENERATED BY *[GRID, TRACE METHODS] CONTROLLING METHODS ON A NETWORK OF RANDOM POINTS SUPPLEMENTED WITH BREAK-LINE POINTS TO PROPERLY ESTABLISH THE TERRAIN MODEL. CONTOURS WILL BE GENERATED USING STANDARD DTM/CADD APPLICATION SOFTWARE.

b. PLANIMETRIC FEATURE DATA DETAILING. THE MAPS SHALL CONTAIN ALL PLANIMETRIC FEATURES ENCOUNTERED WITHIN THE PROJECT LIMITS AND COMPATIBLE WITH THE TYPE OF PROJECT INVOLVED (I.E., MILITARY MASTER PLANNING, ENGINEERING SITE PLAN MAPPING, ETC.) THESE SHALL INCLUDE, BUT NOT BE LIMITED TO, BUILDINGS; ROADS; SEWER SERVICE LINES; UTILITY SYSTEMS, SURFACE AND SUBSURFACE INCLUDING ALL APPURTENANCES, SUCH AS COMMUNICATION, GAS, WATER, FUEL, ELECTRIC, TELEPHONE, OVERHEAD POWER LINES, TRANSMISSION PIPELINES; STORM DRAINAGE FEATURES AND STRUCTURES, BRIDGES, CULVERTS, PIERS, SPILLWAYS, CHANNEL SYSTEMS; TIMBERED AREAS, LANDSCAPES AND INDIVIDUAL TREES THAT ARE RECOGNIZED AS SUCH; RECREATION AREAS; CEMETERIES; *[], ETC. *[FEATURES/UTILITIES SHALL BE SKETCHED IN DETAIL AND SHOWN ON A SEPARATE SHEET OR, WHERE APPLICABLE, SHOWN ON THE MAP SHEET(S) PROPERLY INDEXED IN RELATION TO LOCATION].

(1) *SURFACE UTILITY DATA. LOCATE AND IDENTIFY ALL CULVERTS (PIPES OR BOX DRAINS); WATER SYSTEMS INCLUDING VALVES AND METERS; CATCH BASIN INLETS AND OUTLETS; MANHOLES

(STORM, SANITARY, TELEPHONE, GAS, ELECTRIC); METER/VALVE BOXES; OVERHEAD POWER POLE LOCATION AND TYPE; LOW WIRE HEIGHTS; OVERHEAD TOWERS; AND TRANSFORMERS. OBTAIN PHOTOGRAPHS AND/OR SKETCHES AS DESIGNATED. *[SPECIFY UTILITY DETAIL REQUIREMENTS, SKETCHES, DETAIL SHEETS, ETC.]

(2) *SUBSURFACE UTILITY DATA. FOR DESIGNATED SUBSURFACE UTILITIES, SHOW ALL SYSTEMS AND APPURTENANCES. PROVIDE PIPE/CONDUIT ALIGNMENT, TYPE, SIZE, *[SUBSURFACE PROFILE], JUNCTION POINTS, ETC.; OBTAIN TOP AND INVERT ELEVATIONS OF ALL [].

(3) *HIGHWAYS, ROADS, AND STREETS. OBTAIN NAMES, DESCRIPTIONS, CLASSIFICATIONS; CENTER-LINE PROFILES OR SECTIONS AS DESIGNATED; ROUTE CLASSIFICATION; PAVEMENT WIDTH AND TYPE AND CONDITION OF SURFACE. WHERE DESIGNATED, SHOW CURB AND GUTTER AND JOINT LAYOUT FOR CONCRETE PAVEMENT.

(4) *BRIDGES AND CULVERTS. OBTAIN DIMENSIONS AND STRUCTURAL TYPE AND CONDITION; MEASURE DECK, FLOW LINE, AND CLEARANCE ELEVATIONS; HORIZONTAL CLEARANCES BETWEEN ABUTMENTS AND PIERS, IF ANY; AND WIDTH OF PIERS. INCLUDE DETAILED PLAN AND ELEVATION SKETCHES, OBTAIN PHOTOGRAPHS UPSTREAM AND DOWNSTREAM.

(5) *BUILDINGS AND PERTINENT STRUCTURES. OBTAIN PROPER NAMES OF ALL BUILDINGS OR LANDMARKS; PROPER NAMES, INSTALLATION NUMBERING, AND/OR DESCRIPTIONS OF ALL BUILDINGS AND OTHER STRUCTURES AFFECTED OR POSSIBLY AFFECTED BY THE PROJECT; FOUNDATION AND FIRST-FLOOR ELEVATIONS OF THOSE STRUCTURES WITHIN DESIGNATED LIMITS AND/OR ELEVATIONS BELOW [] FT; BASEMENT ELEVATIONS; SEWER/DRAIN OUTLET INFORMATION BELOW ELEVATION []. OBTAIN PHOTOGRAPHS OF BUILDINGS AND STRUCTURES.

(6) *LOCATE AND SHOW TYPE, SIZE, AND APPROXIMATE NUMBER OF TREES PER *[] SQUARE FEET OF AREA AS REQUIRED TO PROPERLY ACCESS CLEARING REQUIREMENTS. ACCURATELY LOCATE AND DESCRIBE ALL SCATTERED, INDIVIDUAL TREES IN EXCESS OF *[] IN. DIAMETER.

NOTE: Describe any special requirements for detailed drawings. Add to and elaborate on any of the above instructions on feature detail or utility data as required to properly develop a utility plan and that which may be critical to the particular project, especially if relocation work is to be performed. Specify any areas where planimetric/utility feature detail is especially important, or where it may be deemphasized. Also specify any requirements for field verification of utilities vs. taken from as-built plans.

C.5.3 FINAL SITE PLAN MAPS AND/OR DIGITAL DATA CONTENTS.

a. COORDINATE GRID. UNLESS OTHERWISE SPECIFIED, THE GRID SYSTEM SHALL BE ESTABLISHED ON THE LOCAL STATE PLANE COORDINATE SYSTEM (SPCS) *[UNIVERSAL TRANSVERSE MERCATOR (UTM)]. GRID TICKS SHALL BE PLACED ON THE MAP SHEETS AT FIVE (5) INCH INTERVALS WITH COORDINATE VALUES PROPERLY ANNOTATED AND SHOWN AT THE TOP AND RIGHT EDGE OF EACH MAP SHEET.

b. ALL HORIZONTAL AND VERTICAL CONTROLS SHALL BE PLOTTED ON THE MAP TO AN ACCURACY OF *[] RELATIVE TO THEIR TRUE POSITION. PRIMARY CONTROL SET TO CONTROL CONSTRUCTION PHASES SHALL BE LABELED AS SUCH.

c. MULTIPLE MAP SHEETS SHALL CONTAIN AN INDEX OF THE SHEET LAYOUT ORIENTED *[NORTH] [] TO EACH SHEET. MATCH LINES/MATCH GRID SHALL BE PROVIDED AND PROPERLY LABELED SUCH THAT EACH SHEET MAY BE JOINED ACCURATELY TO ADJACENT SHEETS.

d. SYMBOLOGY USED ON THE MAP SHEETS SHALL BE IN ACCORDANCE WITH CADD A/E/C STANDARDS.

e. THE TITLE BLOCK, SHEET INDEX, AND LEGEND SHALL BE PLACED ON THE MAP SHEETS TO THE DESIGNATED SIZE AND ARRANGEMENT PER CADD A/E/C STANDARDS. THE TITLE BLOCK SHALL INCLUDE THE NAME OF THE CONTRACTING AGENCY, PROJECT NAME, DATE, SCALE, AND NAME OF THE CONTRACTOR PERFORMING THE WORK. THE TITLE BLOCK CONTENTS *[SHEET INDEX REQUIREMENTS][LEGEND REQUIREMENTS] WILL BE FURNISHED TO THE CONTRACTOR. *[THE

EM 1110-1-1005
1 Jan 07

CONTRACTOR'S NAME/ADDRESS, CONTRACT/DELIVERY ORDER NUMBER, AND LOGO WILL BE PLACED ON EACH MAP SHEET] *[ADD APPLICABLE PROFESSIONAL CERTIFICATION REQUIREMENTS].

f. ALL DESIGN FILES WITH SUPPORTING DATA SHALL BE FURNISHED ON TRANSFERABLE MEDIA. THE FORMAT SPECIFIED WILL BE DEPENDENT ON THE OPERATING SYSTEM OF THE DESIGN WORKSTATION [DXF][DGN] OTHER.

g. COMPLETED MAPS, REPRODUCTIONS, COMPILATION DATA, DIGITAL DATA SHALL BE DELIVERED IN ACCORDANCE WITH THE WORK ORDER REQUIREMENTS.

C.6 QUALITY CONTROL AND ASSURANCE STANDARDS.

C.6.1. CONTRACTOR QUALITY CONTROL.

a. GENERAL. ALL FINAL MAPPING DATA SUBMITTED UNDER THIS CONTRACT SHALL CONFORM TO THE ACCURACY STANDARDS OUTLINED IN EM 1110-1-1005 UNLESS MODIFIED OR SUPPLEMENTED BELOW. THE CONTRACTOR SHALL BE RESPONSIBLE FOR ALL INTERNAL QUALITY CONTROL FUNCTIONS FOR ALL PHASES OF THE WORK AS REQUIRED TO ASSURE THE COMPLETENESS AND ACCURACY OF FINAL COMPILED MAPS.

b. MATERIALS. ALL MATERIALS, SUPPLIES, OR ARTICLES REQUIRED FOR WORK THAT ARE NOT COVERED HEREIN, OR BY WORK ORDER SPECIFICATIONS, SHALL BE STANDARD PRODUCTS OF REPUTABLE MANUFACTURERS, AND ENTIRELY SUITABLE FOR THE INTENDED PURPOSE. UNLESS OTHERWISE SPECIFIED, THEY SHALL BE NEW AND UNUSED AND SUBJECT TO THE APPROVAL OF THE CONTRACTING OFFICER.

c. METHODS FOR EVALUATING MAP ACCURACY. ALL MAPS COMPILED SHALL BE SUBJECT TO MAP TESTING BY THE GOVERNMENT, BY INDEPENDENT THIRD-PARTY FORCES, OR BY CONTRACTOR FORCES WORKING UNDER DIRECT GOVERNMENT REVIEW, TO ENSURE THAT THEY COMPLY WITH THE APPLICABLE ACCURACY REQUIREMENTS STATED IN THE CONTRACT. THE MAP TEST RESULTS WILL BE STATISTICALLY EVALUATED RELATIVE TO THE DEFINED ACCURACY CRITERIA, AND PASS/FAIL DETERMINATION MADE ACCORDINGLY. THE DECISION OF WHETHER OR NOT TO PERFORM RIGID MAP TESTING ON ANY PROJECT, DELIVERY ORDER, OR PORTION OF A PROJECT RESTS WITH THE CONTRACTING OFFICER. IN ALL CASES, THE CONTRACTOR WILL BE ADVISED IN WRITING WHEN SUCH ACTION WILL BE TAKEN.

NOTE: Specify and reference the map accuracy standard and accompanying testing criteria required. The ASPRS standard is recommended for USACE large-scale mapping work. Alternatively, standards set forth in EM 1110-1-1005 or, if applicable, contained in other EMs may be used and simply referenced in this contract.

NOTE: For fixed-scope contracts, indicate the degree of formal map testing contemplated, and by whom. If performed by contractor survey forces, allow adequate field survey time in Section B. On IDC contracts, formal map accuracy tests are optional for each delivery order. The need for map tests is a function of the ultimate or intended use of the maps.

C.7 SUBMITTAL REQUIREMENTS.

C.7.1. SUBMITTAL SCHEDULE. THE COMPLETED WORK, MAPS, AND REPORTS SHALL BE DELIVERED WITHIN *[DAYS AFTER NOTICE TO PROCEED IS ISSUED] *[BY CALENDAR DATE].

NOTE: Include a more detailed submittal schedule breakdown if applicable to the project. Note any preliminary, priority, or partial delivery requirements, with reference to specific Section B line items.

C.8 PROGRESS SCHEDULES AND WRITTEN REPORTS.

C.8.1. *PREWORK CONFERENCE/IN-PROGRESS REVIEW CONFERENCES.

NOTE: Detail any requirements for prework or in-progress review conferences, including requirements for preparing written reports for such conferences.

SECTION D--CONTRACT ADMINISTRATION DATA

SECTION E--SPECIAL CONTRACT REQUIREMENTS

SECTION F--CONTRACT CLAUSES

**SECTION G
LIST OF ATTACHMENTS**

G.1 U.S. ARMY CORPS OF ENGINEERS EM 1110-1-1005. THIS REFERENCE IS ATTACHED TO AND MADE PART OF THIS CONTRACT.

NOTE: List any other attachments called for in contract Section C or in other contract sections. This may include such items as:

- a. Marked-up exhibits, project sketches/drawings.
- b. Station/Monument descriptions or Recovery Notes.
- c. Drafting Standards.
- d. Applicable CADD/GIS Technology Center Standards.

**SECTION H
REPRESENTATIONS, CERTIFICATIONS, AND OTHER STATEMENTS OF OFFERERS**

**SECTION I
INSTRUCTIONS, CONDITIONS, AND NOTICES TO OFFERERS**

Appendix E

Application: Topographic Survey of Beach Sections Adjacent to Tillamook North Jetty, Oregon (Portland District)

E-1. Purpose and Background

This is a survey of a 1,000 ft section of beach near the town of Tillamook, OR. Tillamook is a small community in Northern Oregon on the Pacific Ocean. The jetty protects the entrance to Tillamook Bay. The purpose of the survey was to satisfy permitting requirements imposed by the state of Oregon prior to construction of a revetment protecting the root of the North Jetty. A Purchase Order was issued to Chase-Jones and Associates, Inc to perform the survey in September 2004. The contractor laid out the baseline and collected the topographic data in two days. The field data was processed and a MicroStation DGN file created by Portland District personnel.

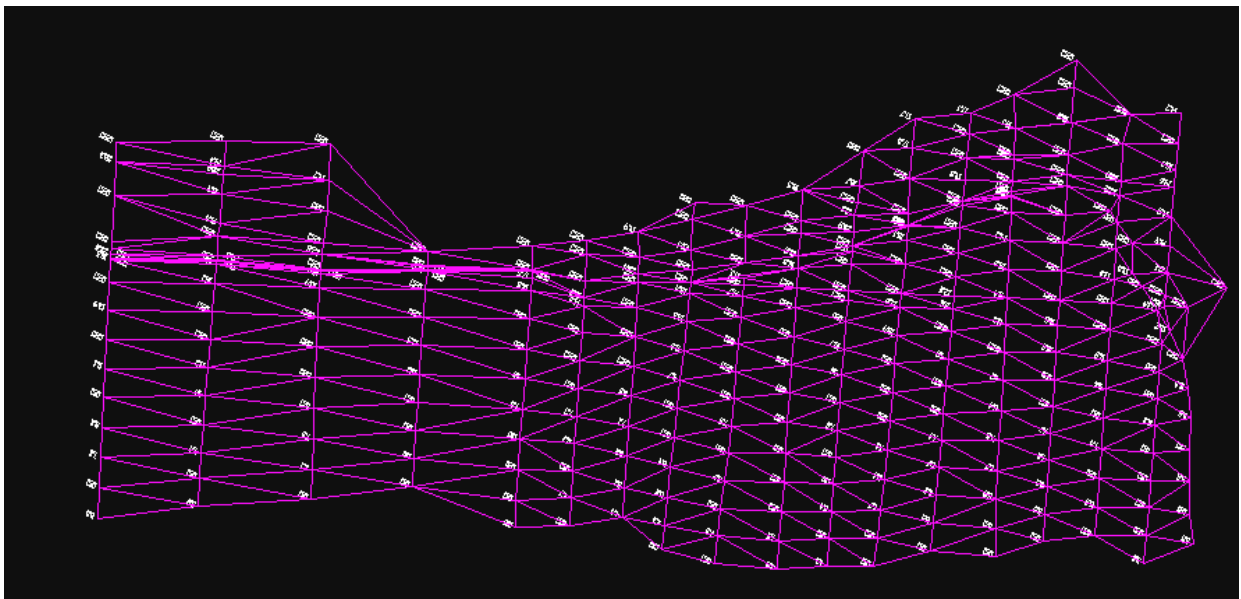

Figure E-1. TIN/DTM of surveyed cross-sections showing 18 cross-sections spaced at 50 ft and 100 ft C/C

E-2. Scope of Work

The following scope of work was drafted by the Survey Section in the Portland District.

**Scope of Work
Tillamook North Jetty Cross Sections
Contract Number DACW57-02-0007
09/03/2004**

1.0 General

The project is located on the beach adjacent to the North Tillamook Jetty near the town of Tillamook in the State of Oregon.

This task order is for the production of fieldwork only. Data reduction and mapping will be completed by the government from the raw data supplied by the contractor.

2.0 General Tasks:

2.1 Layout and tie a 1000-foot baseline approximately perpendicular to the jetty and a minimum of 100 feet inland of the vegetation line. The end of the baseline shall be monument as directed by the government. Station 0+00 shall be immediately adjacent to the north jetty.

2.2 Collect Topographic profile parallel to the baseline at the mid-tide line.

2.3 Collect topographic cross-sections at 50 foot spacings between baseline station 0+00 and 6+00 (13 Cross-Sections)

2.4 Collect topographic cross-sections at 100 foot spacings between baseline station 6+00 and 10+00. (4 cross-sections)

2.5 Provide Digital photos of the set monuments, Cross-sections and profiles.

3.0 Exhibits and Materials

The Government will furnish the following items:

- 3.1 Control Diagram showing recently established project control monuments
- 3.2 Proposed cross section layout
- 3.3 Pertinent manuals as needed can be obtained from the internet at
<http://www.usace.army.mil/inet/usace-docs/eng-manuals>
- 3.5 Photos and Maps of the project area

4.0 Field Procedure

4.1 All work shall be completed in accordance with the Engineer Manual for Topographic Surveying EM 1110-1-1005 dated 31 August 1994

4.2 Access. The survey areas should not present any right-of-entry problems

5.0 Office Procedures

This task is for the production of fieldwork only. Develop a narrative detailing project approach and any complications. Include all Field-crew daily reports and reports of safety meetings.

6.0 Data Submission Standards.

1. The Contractor shall submit data as electronic data. Supplemental data shall be submitted in field books. Electronic data shall be formatted in Leica Corporations GSI format and submitted on a Compact Disk (CD). Format for field notebook shall be supplied upon request.

2. For each CD submitted provide a text file with the following data: Serial Number and type of instrument used, names of the crewmembers, dates of the survey, and weather. The intention is to provide the same information recorded in a field book. This data is essential. In addition provide a text file for each CD with directory and file information.

3. Paper print outs of the electronic data shall not be submitted as a substitute for the electronic data.

4. Leveling measurements shall be submitted digitally. Data shall be formatted in Leica Corp. GSI format.

5. Raw digital Radiation data shall be "coded" for input into either Listech Corp. Liscad Version 6.x software or Leica Corporations Wildsoft software. Raw data shall be submitted in Leica Corp. GSI format.

6. Field books and hand written forms used for data collections shall be scanned and submitted on a CD. The intention is to provide an electronic record for archival. Place all scanned field book pages in one file formatted in Adobe Acrobat. PDF

7. Information shall be dated and submitted in a neat, consecutive and organized manner. The outside of the CD as well as the case shall be clearly marked (labeled) with the following information:

Job Name
Contractors Name
Contract Number Task Order
Date

8. Narrative data submitted shall be submitted in Microsoft Word format.

9. Provide a Final "Surveyor's Report." Provide the report in Adobe Acrobat. PDF format.

7.0 Deliverables and Completion of Work

Field work shall be completed by 13 Sep 2004. Deliver all relevant items delivered no later than 14 calendar days after Notification to Proceed.

End of Scope

E-3. Level Line Data Files and Adjustment

Levels were run from BM SCOTT HIXON (AKA SCOTTH)--elevation 19.040 ft NAVD 88--to baseline station (-) 0+20, then to baseline station (+)10+00, then looped back to SCOTTH.

Levels were run with a Leica NA 2002 digital level. Following is the raw datafile from the digital level output.

BM/TP	BM Elev/dist/dist	BS/FS	Elev
410001+?.....1			
110002+00000001	83..11+00019040		
110003+00000001	32..01+00030170	331101+00005899	52..07+0003+001
110004+00000001	32..01+00027130	332101+00004081	52..07+0003+001
110005+00000001	573..1+00003030	574..1+00057300	83..01+00020858
110006+00000001	32..01+00151790	331101+00003892	52..07+0003+006
110007+00000002	32..01+00144020	332101+00010116	52..07+0003+002
110008+00000002	573..1+00010800	574..1+00353120	83..01+00014634
110009+00000002	32..01+00169970	331101+00004230	52..07+0003+004
110010+00000003	32..01+00162490	332101+00004199	52..07+0003+004
110011+00000003	573..1+00018280	574..1+00685580	83..01+00014666
110012+00000003	32..01+00176190	331101+00004580	52..07+0003+016
110013+00000004	32..01+00163280	332101+00004149	52..07+0003+002
110014+00000004	573..1+00031190	574..1+01025050	83..01+00015097
110015+00000004	32..01+00069300	331101+00012085	52..07+0003+000
110016+00000005	32..01+00072260	332101+00004164	52..07+0003+000
110017+00000005	573..1+00028230	574..1+01166600	83..01+00023018
110018+00000005	32..01+00072230	331101+00004093	52..07+0003+002
110019+00000006	32..01+00069300	332101+00012014	52..07+0003+001
110020+00000006	573..1+00031160	574..1+01308130	83..01+00015097
110021+00000006	32..01+00133360	331101+00004053	52..07+0003+001
110022+00000007	32..01+00155650	332101+00005042	52..07+0003+005
110023+00000007	573..1+00008870	574..1+01597150	83..01+00014108
110024+00000007	32..01+00152030	331101+00004162	52..07+0003+002
110025+00000008	32..01+00148150	332101+00004834	52..07+0003+004
110026+00000008	573..1+00012750	574..1+01897330	83..01+00013436
110027+00000008	32..01+00089820	331101+00009545	52..07+0003+001
110028+00000009	32..01+00022370	332101+00001346	52..07+0003+001
110029+00000009	573..1+00080200	574..1+02009510	83..01+00021635
410030+!....332			
110031+00000009	32..01+00083730	332101+00008085	52..07+0003+003
110032+00000009	573..1+00018830	574..1+02070880	83..01+00014896
110033+00000009	32..01+00104820	331101+00009404	52..07+0003+001
110034+00000010	32..01+00146140	332101+00005265	52..07+0003+001
110035+00000010	573..1-00022490	574..1+02321850	83..01+00019034

The following file shows the reduced field notes that were generated from the above raw datafile. This report was generated by Leica Geosystem's LevelPak Software.

LevelPak Level Line Report

Project : BaseLineLevels
Generated : 17/09/2004 at 07:21:18
Unit : US Feet
Level Line: levels Line 001
Heights : Calculated

Active	Pt Name	Back	Tp.	Intmdt.	Fore	Dist	Height	Comments
x	100						19.040	Scott Hixon (AKA ScottH)
x	100	5.8990				30.17		
x	1				4.0810	27.13		
x	1						20.858	-0+22 AL Cap
x	1	3.8920				151.79		
x	2				10.1160	144.02		
x	2						14.635	
x	2	4.2300				169.97		
x	3				4.1990	162.49		
x	3	4.5800				176.19		
x	4				4.1490	163.28		
x	4						15.099	
x	4	12.0850				69.30		
x	5				4.1640	72.26		
x	5						23.020	10+00 Al Cap
x	5	4.0930				72.23		
x	6				12.0140	69.30		
x	6						15.099	
x	6	4.0530				133.36		
x	7				5.0420	155.65		
x	7	4.1620				152.03		
x	8				4.8340	148.15		
x	8						13.440	
x	8	9.5450				89.82		
x	9				1.3460	22.37		
x	9						21.635	
x	9				8.0850	83.73		
x	9	9.4040				104.82		
x	100				5.2650	146.14		
x	100						19.040	ScottH

Level Line Memo:

1. Level line start point '100'
2. Level line end point '100'
3. Detected level loop
4. Checking completed

E-4. Horizontal Control Observations--LISCAD Baseline Report

Horizontal control for the baseline was established by total station observations from two nearby control points--BAR and SCOTTH. Ties were made to each end of the marked baseline (stations (-) 0+22 and 10+00).

The following file (xsections.fld) contains a sample portion the reformatted total station observations, from the original raw Leica "xsections.gsi" data file. A total of 299 ground shots were taken on this project (point numbers 100-399). This file below shows the initial control observations in establishing the baseline end points (i.e. lines 10-39). Actual ground shots begin at line 42 (Shot # 100 on cross-section 0+00--approx 183 ft ESE of baseline). The total station occupied point "(-) 0+22" (shown on plate below) and was backsighted on 10+00 (dashed line from 0+22 to NE).

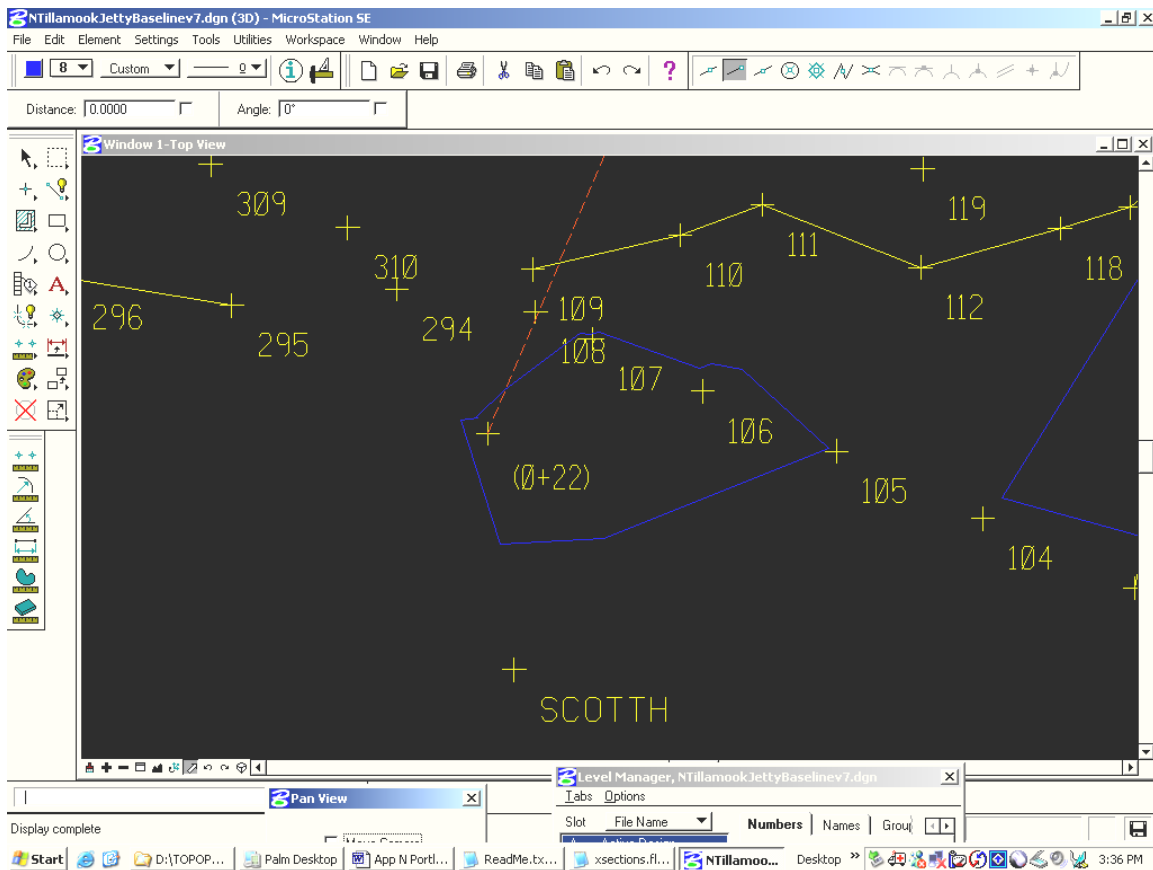

Figure E-2. Total Station occupied Point "0+22"

```

1 010 Leica TPS-1100 Series xsections.gsi
2 011 Friday, September 17, 2004
3 051 DM
4 053 F
5 021 YX
6 ; Reformatting error... 410001+00000001
7 ;
8 102 BAR 5.3100 5.2500 SCOTTH 0.00010
9 105 5.2500
900 160 1 6 0
10 111 SCOTTH 0.00010 90.32020 314.7850 00500
11 111 (0+22) 352.42230 90.03010 303.7050 00500
12 111 (0+22) 172.42200 269.56310 303.7050 00500
13 111 SCOTTH 180.00030 269.27440 314.7850 00500
14 111 SCOTTH 0.00000 90.32060 314.7850 00500
15 111 (0+22) 352.42260 90.03070 303.7050 00500
16 111 (0+22) 172.42250 269.56500 303.7050 00500
17 111 SCOTTH 179.59590 269.27520 314.7850 00500
18 111 SCOTTH 0.00010 90.32080 314.7850 00500
19 111 (0+22) 352.42250 90.03130 303.7050 00500
20 111 (0+22) 172.42240 269.56420 303.7050 00500
21 111 SCOTTH 180.00060 269.27450 314.7850 00500
210 161
22 ;
23 102 BAR 5.3100 5.2500 SCOTTH 0.00020
24 105 5.2500
240 160 1 6 0
25 111 SCOTTH 0.00020 90.32100 314.7860 00500
26 111 10+00 294.29320 89.53310 1148.9360 00500
27 111 10+00 114.29310 270.06200 1148.9360 00500
28 111 SCOTTH 180.00020 269.27480 314.7850 00500
29 111 SCOTTH 0.00010 90.32070 314.7860 00500
30 111 10+00 294.29340 89.53310 1148.9360 00500
31 111 10+00 114.29320 270.06200 1148.9360 00500
32 111 SCOTTH 180.00000 269.27400 314.7850 00500
33 111 SCOTTH 0.00010 90.32070 314.7850 00500
34 111 10+00 294.29310 89.53270 1148.9360 00500
35 111 10+00 114.29320 270.06250 1148.9360 00500
36 111 SCOTTH 180.00020 269.27460 314.7850 00500
360 161
37 ;
38 102 (0+22) 5.2500 5.0000 10+00 0.00000
39 111 10+00 0.00000 89.51420 1022.1050 00500
40 401 8 7 8
41 105 5.0000
42 111 100 84.52270 92.09240 183.1380 00501
43 111 101 83.34080 92.18390 154.8770 00501
44 111 102 81.57570 91.52030 130.3390 00503
45 111 103 80.32470 90.46510 114.6400 00502
46 111 104 76.53190 90.52480 86.4980 00505
47 111 105 70.04020 91.07120 60.1440 00505
48 111 106 56.02270 90.03340 37.7470 00505
49 111 107 25.11530 91.32280 24.3200 00502
50 111 108 358.33460 96.58450 22.6920 00505
51 401 7 7 7
52 111 109 352.36010 103.45150 30.2010 00503
53 111 110 21.20190 98.37400 48.1060 00503
54 111 111 27.24050 96.46480 61.9660 00503
55 111 112 46.10570 92.49320 79.9320 00503
56 123 (0+22) 112 0.0000 0.0000 -2.0000
57 111 113 47.47160 92.12560 117.4570 00503
58 401 8 7 8
59 111 114 70.24380 91.03230 189.8970 00501
60 111 115 65.10300 90.35100 166.4560 00501
61 111 116 59.08430 90.27550 134.8910 00501
62 111 117 55.45390 89.29020 124.0940 00502
63 111 118 47.28260 92.42590 104.8100 00503
64 111 119 35.54060 94.07520 87.9200 00501
65 111 120 17.53450 95.40390 75.4540 00501

```

The horizontal adjustment of the baseline end points (-) 0+22 and 10+00 is shown on the following report. BAR and SCOTTH were fixed in position. LISCAD is a Engineering and Surveying software program by Listech Inc. and distributed by Leica Geosystems, Inc. Input data for the adjustment was taken from xsections.fld file. Station BAR was occupied and 3 sets were observed to (-)0+22 and 10+00 (relative to SCOTTH), and the directions meaned in the LISCAD software. Both ends of the baseline were then occupied, but only distances were observed for adjustment.

LISCAD Report: Rounds Report
Friday, September 17, 2004 08:38

File: NTillamookJettyBaseline
Projection: Oregon NAD83 North 3601
File Date: Friday, September 17, 2004

Units
=====

Angle: Degrees Minutes Seconds
Distance: US Feet

At BAR

To SCOTTH (Backsight reduced to zero)

Horizontal	Vertical	Face Diff.	Residual
0 00 00	90 32 09	0 00 14	-0 00 00
0 00 00	90 32 07	0 00 02	-0 00 02
0 00 00	90 32 12	0 00 07	0 00 02
Mean of Sets.			
Horizontal	Vertical	SD. Vert.	Range
0 00 00	90 32 09	0 00 02	0 00 04
Distance	SD Dist.	Range	
314.785	0.000	0.000	

To 0+22

Horizontal	Split	Residual	Vertical	Face Diff.	Residual
352 42 19	-0 00 05	-0 00 03	90 03 15	0 00 28	0 00 02
352 42 26	0 00 00	0 00 04	90 03 08	0 00 03	-0 00 04
352 42 21	-0 00 06	-0 00 01	90 03 15	0 00 05	0 00 02
Mean of Sets.					
Horizontal	SD Dir.	Range	Vertical	SD. Vert.	Range
352 42 22	0 00 03	0 00 07	90 03 13	0 00 04	0 00 07
Distance	SD Dist.	Range			
303.705	0.000	0.000			

At BAR

To SCOTTH (Backsight reduced to zero)

Horizontal	Vertical	Face Diff.	Residual
0 00 00	90 32 11	0 00 02	-0 00 01
0 00 00	90 32 13	0 00 13	0 00 02
0 00 00	90 32 10	0 00 07	-0 00 01
Mean of Sets.			
Horizontal	Vertical	SD. Vert.	Range
0 00 00	90 32 12	0 00 02	0 00 03
Distance	SD Dist.	Range	
314.785	0.000	0.001	

To 10+00

Horizontal	Split	Residual	Vertical	Face Diff.	Residual
294 29 29	-0 00 01	-0 00 01	89 53 35	0 00 09	0 00 01
294 29 33	-0 00 01	0 00 02	89 53 35	0 00 09	0 00 01
294 29 30	0 00 00	-0 00 01	89 53 31	0 00 08	-0 00 03
Mean of Sets.					
Horizontal	SD Dir.	Range	Vertical	SD. Vert.	Range
294 29 31	0 00 02	0 00 03	89 53 34	0 00 03	0 00 04
Distance	SD Dist.	Range			
1148.936	0.000	0.000			

LISCAD Report: Least Squares Adjustment Report -
Friday, September 17, 2004 08:39

File: NTillamookJettyBaseline
Projection: Oregon NAD83 North 3601
File Date: Friday, September 17, 2004

Units
=====

Angle: Degrees Minutes Seconds
Distance: US Feet

Earth constants
=====

Refraction constant: 0.070
Average elevation: 0.0
Geoidal separation: 0.0

Fixed Coordinates

Point ID	North	East	Latitude	Longitude	Grid Conv.	P.S.F.
BAR	712957.055	7316648.559	45^34 12.92	-123^57 31.16	-2^27 10	0.99991911
SCOTTH	712886.399	7316955.291	45^34 12.35	-123^57 26.81	-2^27 07	0.99991909

Adjusted Coordinates

Point ID	North	East	Latitude	Longitude	Grid Conv.	P.S.F.
0+22	712927.013	7316950.750	45^34 12.75	-123^57 26.89	-2^27 07	0.99991911
10+00	713868.924	7317347.359	45^34 22.21	-123^57 21.89	-2^27 04	0.99991943

Observations

Directions							
At	To	Direction	+/-SD	Residual	Orientation Fwd.	Proj. Geo.	
Az.							
BAR	SCOTTH	0°00'00"	0°00'04"	0°00'01"	102°58'18"	102°58'19"	
BAR	0+22	352°42'22"	0°00'04"	-0°00'01"		95°40'39"	
BAR	SCOTTH	0°00'00"	0°00'04"	-0°00'01"	102°58'20"	102°58'19"	
BAR	10+00	294°29'31"	0°00'04"	0°00'01"		37°27'51"	
0+22	10+00	0°00'00"	0°00'10"	0°00'00"	22°50'04"	22°50'04"	
10+00	0+22	0°00'01"	0°00'10"	0°00'00"	202°50'03"	202°50'04"	
10+00	0+22	0°00'00"	0°00'10"	0°00'00"	202°50'04"	202°50'04"	
0+22	10+00	359°59'59"	0°00'10"	0°00'00"	22°50'05"	22°50'04"	
Distances							
At	To	Distance	+/-SD	Residual	S.L.C.	Grid	L.S.F.
BAR	SCOTTH	314.771	0.007	0.019	0.000	314.765	0.99991910
BAR	0+22	303.705	0.007	0.001	0.000	303.681	0.99991911
BAR	SCOTTH	314.772	0.007	0.019	0.000	314.765	0.99991910
BAR	10+00	1148.934	0.009	-0.004	0.001	1148.837	0.99991927
10+00	0+22	1022.106	0.022	-0.018	-0.000	1022.006	0.99991927
10+00	0+22	1022.071	0.022	0.018	-0.000	1022.006	0.99991927
0+22	10+00	1022.068	0.022	0.021	-0.000	1022.006	0.99991927

Statistics

 Degrees of Freedom: 3
 Fixed Coordinates: 2
 Floating Coordinates: 2
 Observations: 13
 Directions: 8
 Orientation: 6
 Distances: 5
 Number of Iterations: 2

Error Analysis

 Variance Factor: 5.38

Point ID	Adjusted Coordinates		+/- 95% Confidence Limits		Error Ellipse		
	North	East	North	East	Semi Major	Semi Minor	Orient
0+22	712927.013	7316950.750	0.057	0.053	0.057	0.053	164°18'33"
10+00	713868.924	7317347.359	0.128	0.183	0.216	0.058	123°22'51"

The following plate depicts individual ground shots and breaklines at top of bank and toe of bank.

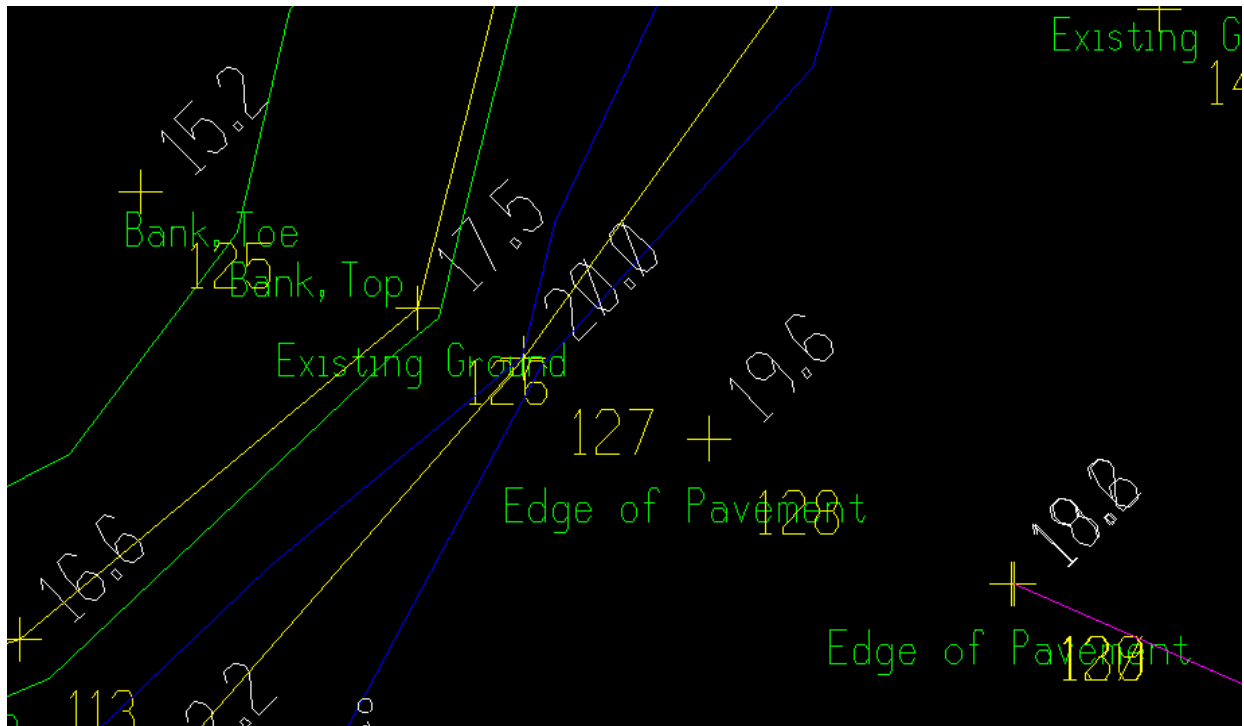

Figure E-3. Breaklines

Appendix F
Application: Topographic Survey for Relocation of Red Feather Prairie Bike Trail, Saylorville Lake Project, Iowa (Rock Island District)

F-1. Purpose

This is a metric design project performed by Rock Island District personnel. The purpose of the project was to relocate an existing bike trail at the site. Additional topographic survey data was needed to cover potential relocation areas. The field survey of the 11-acre site was performed on 17-20 Nov 97 and 27-29 Jan 98--a total of seven crew days in the field. Two- and four-man field crews were used at different points in time on this project. Approximately 538 control and topographic observations were recorded on a Pentax total station with an external data collector. Differential levels were also run through the primary control points. A total of 12 primary control points were connected by an open-ended total station traverse. The traverse originated at a fixed point (Control Monument SV 127.1A--1965) with a fixed azimuth to Point SV 130.1A--1966. Topography was taken after the control traverse was completed at the project site. The field data were reduced in the Rock Island District Office and the final dataset was created in MicroStation. Fourteen level assignments were used for data collected on this project, as outlined on the drawing note below. The coordinate system used was NAD 27 and elevations were referenced to NGVD 29.

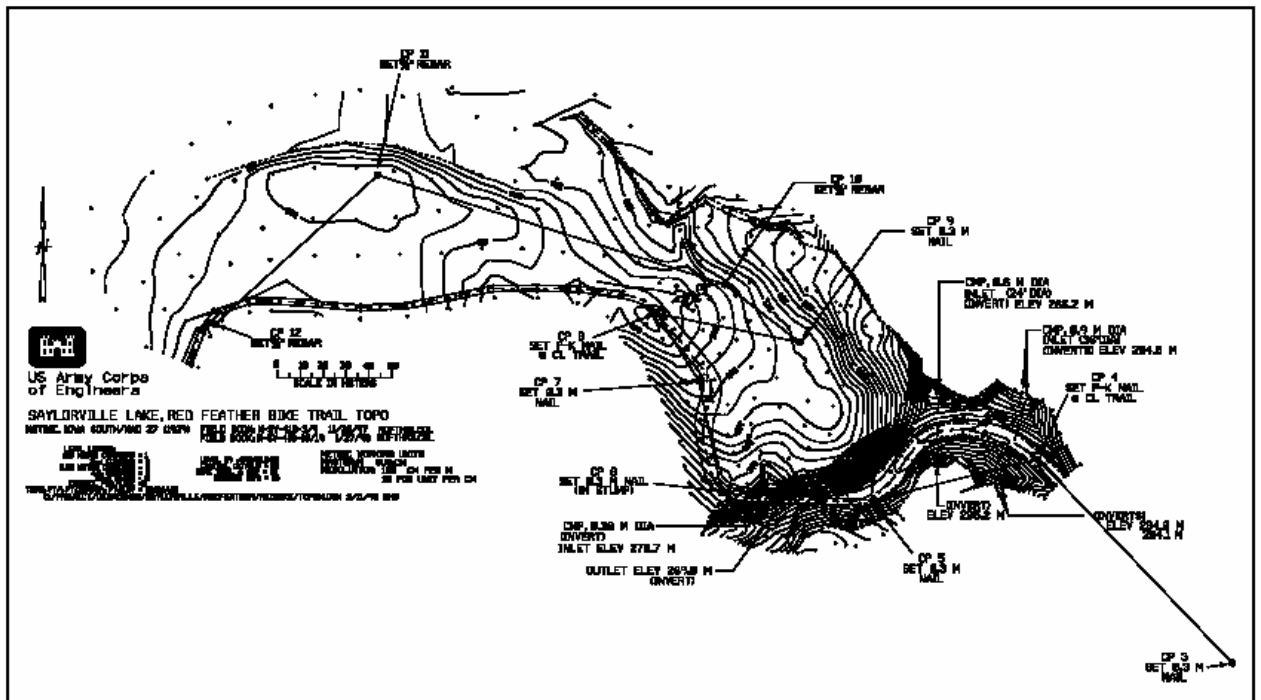

Figure F-1. Overall scheme of 11-acre project area



Figure F-2. Title block and legend from final drawing depicting level assignments in dgn file

F-2. Original Request for Survey

CENCR-ED-DG

22 October 1997
Mr. Kizak/5587

MEMORANDUM THRU

ED-D *JKR/ycb*

FOR ED-S *[Signature]*

SUBJECT: Request for Survey Support, 1998 Bike Trail Repairs, Lake Saylorville, Des Moines River, Polk County, Iowa

1. The following survey support is required for the subject contract.

Topographic data to develop a detailed plan for the relocation of the existing bike trail. This data should include the location of the existing trail centerline and have enough point elevations to develop an accurate topographic map. This information will be used in *Road Calc*.

This information is required in t Red Feather Prairie. See the highlighted section on the attached sheet for the exact location.

2. This is a metric project. Therefore, all data should be surveyed in meters. Thus eliminating the need for conversion and reducing error.
3. The point of contact for this project is Eric R Kizak, ext. 5587. Please coordinate prior to the survey. The labor cost code, ordering work item, the funded work item, and the work category codes for this work are L05787, 001WQY, 001TD7, and 63432 respectively.

John J. Copeland

JOHN J. COPELAND, P.E.
Chief, General Engineering Section

CF:
ED-DG (Kizak)
OD-Y (DeMarce)

F-3. Instructions to Field Survey Team

SURVEY INSTRUCTIONS
RED FEATHER PRAIRIE – BIKE TRAIL REPAIRS
SAYLORVILLE LAKE POLK COUNTY, IOWA

We have been requested to complete the subject surveys described in the attached memo from Mr. Kizak and Mr. Copeland. Previous to this memo, we talked to Mr. Kizak regarding his needs and techniques. The following instructions, and project philosophy reflect that discussion with Mr. Kizak as interpreted somewhat due to knowledge of the area and research into our previous work there.

Required Survey Tasks

Horizontal control tie. Though there is no *stated* need to tie the project to horizontal control (Iowa State Plane Coordinate System), we believe it should be done. It may be done by Total Station or GPS, from the three or four Tract Corners for which description cards and coordinates are supplied. The result should be a "PK" in the center of the trail at each end of the project as shown on *my* sketch. Since the trail site is in a timbered area you may find the Total Station to be the best technology for the work.

Vertical control tie. We are including copies of work, on the last trail revision in the area by Graham and Meeker, that may provide a close-at-hand benchmark. That data is 11 years old and the turns, TBMs, etc. set by the party may have been destroyed in more recent road reconstruction as well as completion of the trail revision for which the work was done. One point referred to (TP "E" in N-SV-357, page 5) was destroyed by removal of a trail bridge on which it was located. Another ("TP 8" in N-SV-357, page 2) in a power pole, may have been destroyed by reconstruction of NW 35th Street, which is now Ia. Hwy. #415. The best alternate starting point is SV control monument DS-3, near the east abutment of the main dam, for which the description is attached.

Site topo control. Since a relatively dense matrix of topo points and existing trail detail point will be needed, I suggest you establish one or two control points in the 90 X 155 -meter site area (cross-hatched on the photomap) to aid in collecting the topo data. *Suggested locations* are shown in green.

Existing trail features. Because the repair/relocation of the trail may utilize some parts of the existing alignment it is essential to map that feature. My suggestion is a centerline profile and shoulder and toe profiles with data points at 10-meter (or closer) intervals, plus data on any existing culverts under that trail. Those shots will be used to construct topo break lines here in the office. Typical cross-sections of the trail at its highest fill station and at two other locations will be of great help also.

Other topo features. To facilitate re-siting the trail in the relatively rough terrain a matrix of topo data points that will provide half-meter contours is required. A rough 10-meter (33-foot) grid matrix would be sufficient. In many cases it will be more efficient and show the contours better if the data points are on ridges, valleys, or water courses. That determination can only be made in the field.

Execution, prosecution, etc.

The work is estimated to require four days field and travel time for the two-person Slight-Ellershoff crew. While it is not difficult it is comprehensive. The operative technical requirement is that the results be furnished in S.I. ("Metric") units. We prefer that the field work be done in that system, though we will discuss options. The cost code data, etc., is included on the copy of the request letter as attached.

ESSAYONS

Attachments



WILLIAM C. RIEBE, L.S.
Chief, Survey Branch

F-4. Control Surveys

An open-ended traverse was run concurrently with the topographic work--see Figure F-3 below. Twelve primary control points were occupied (two control [points outside the project area are not shown below]). Control data were observed/logged with the Pentax total station and also hand recorded in a field survey book.

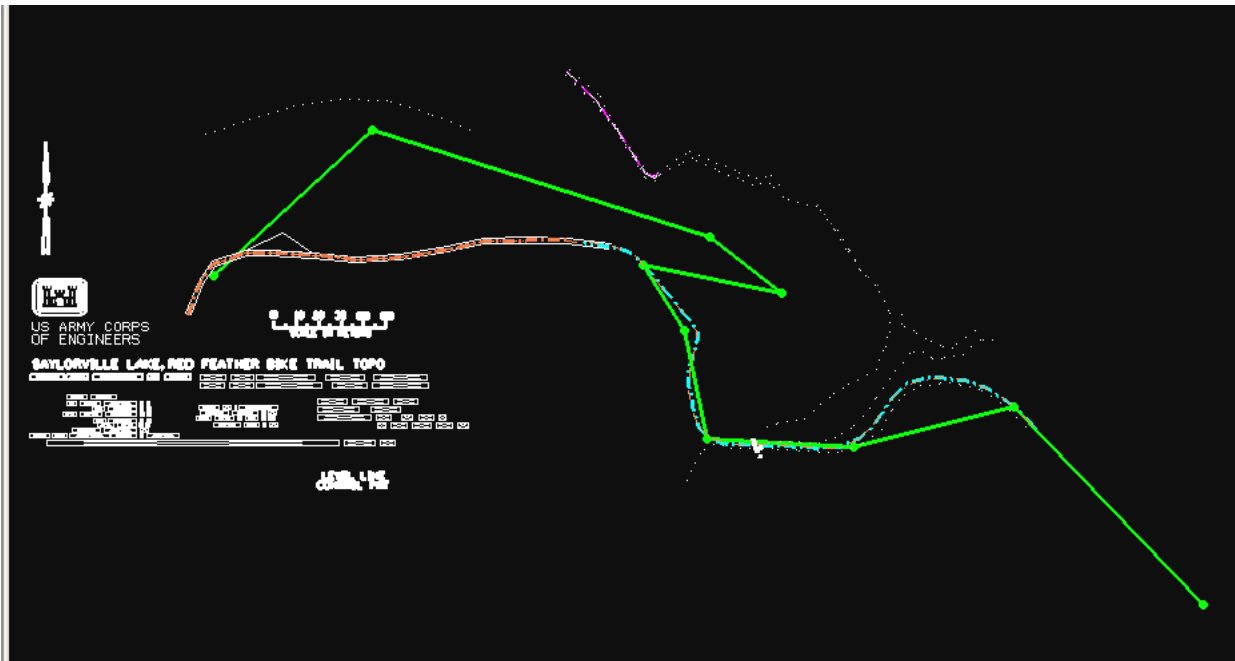
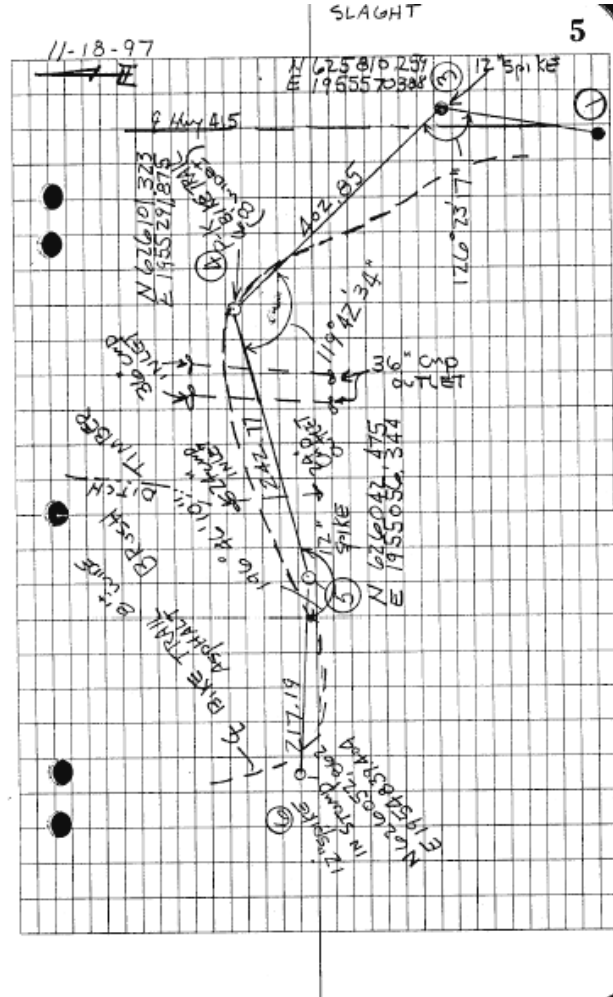

Figure F-3. Primary control traverse (in green) used for controlling topographic mapping of site

Below is a portion from the field book showing horizontal control traverse distance and angle observations from Points 1 through 6. (Point 1 was held fixed in position). A traverse sketch was drawn in the field book for each leg of the traverse and computed coordinates were shown at each traverse point.

5 SAILOR WILE LAKE - RED FEATHER PRAIRIE			
BIKE TRAIL REPAIR TOPO TRAVERSE			
PC (3)	BS (1)	FS (4)	SET P.K. @ B. TRAIL SO. END OF TOPO
DIR	0°00'	REV 179°59'47"	
	126°23'12"	306°23'10"	
MEAN	126°23'17"		0
H. DIST	(3) (4) 402.85		0
PC (4)	BS (3)	FS (5)	SET 12" SPIKE
DIR	0°00'	REV 179°59'44"	
	119°42'32"	299°42'21"	
MEAN	119°42'34"		
H. DIST	(4) (3) 402.85		0
H. DIST	(4) (5) 242.71		
PC (5)	BS (4)	(6)	SET 12" SPIKE
DIR	0°00'	REV 179°59'43"	
	196°46'08"	16°45'56"	
MEAN	196°46'10"		
H. DIST	(5) (4) 242.71		0
H. DIST	(5) (6) 217.19		0



F-5. Data Collection Codes (Rock Island District)

The Rock Island District numerical coding system below was used for the Saylorville Project.

101: GRD SHT	155: MON	308: ASPHALT	601: CL BRIDGE
102: TOP BANK	156: STONE	309: BLACK TOP	602: EDGE BRIDGE
103: TOE BANK	157: PHONE	310: RIPRAP	603: BACKWALL
104: CTR DITCH	158: GUY P	311: GRAVEL	604: BRIDGE SEAT
105: TREE LINE	159: PED P	312: DRIVEWAY	605: LOW STEEL
106: EDGE FIELD	160: P/P	313: DIRT ROAD	606: LOW CONCRETE
107: TREE	161: SIG P	314: APRON	607: PIER
108: EDGE MARSH	162: TEL P	315: CL BIKE TRAIL	608: ABUTEMENT
109: SHOULDER	163: POND	316: PARKING CURB	609: COR. BRDGE
110: EDGE CAMPER PAD	164: POOL	317: TOP RIP RAP	610: CTR TRACKS
111: EDGE PARKING LOT	165: PUMP	318: TOE RIP RAP	611: TOP BALLAST
112: SAND	166: RET WALL	319: EDGE BIKE TRAIL	612: TOE BALLAST
113: TOP/TOE OF BANK	167: R/R	320: TOE CURB	613: EDGE BOAT RAMP
114: CL DRAW	168: S POST	321: SHLDR RD.	620: CL TRACKS
115: CL RIDGE	169: SIGN	322: FIGURE SIGN1	621: TOP BALLAST
116: DRILL HOLE	170: SIG CONT	323: FIGURE SIGN2	622: TOE BALLAST
117: SLOPE INDICATOR	171: SPRING	324: FIGURE TREEC	701: CENTERLINE
118: FENCE LINE	172: S PIPE	325: FIGURE TREED	702: BASE LINE
119: TEMP GUAGE	173: STOP BAR	326: FIGURE WM	703: FLOW LINE
120: EP	174: STREAM	327: FIGURE WV	704: TBM
121: CL FEN	175: SUMP	328: FIGURE WHLCHR	705: BM
122: WD FEN	176: TEL MH	401: INVERT	706: P.I.
123: WI FEN	177: TEL RIS	402: CULVERT	707: P.C.
124: F COR	178: TEL VLT	403: TOP HEADWALL	708: P.T.
125: FH	179: TREE D	404: INLET	709: P.O.T.
126: FOG LN	180: TREE E	405: OUTLET	710: SECTION CORNER
127: GAS FILL	181: VAULT	406: CMP	711: QUARTER CORNER
128: GAS PUMP	182: AC WALK	407: RCP	712: PROPERTY CORNER
129: GM	183: C WALK	408: PVC	713: BOUNDARY
130: GV	184: X WALK	409: TOP PIPE	714: PROPERTY LINE
131: GATE	185: B WALL	501: POWER POLE	715: NORTH
132: GRAV	186: C WALL	502: MANHOLE	716: SOUTH
133: GRD RAIL	187: R WALL	503: HYDRANT	717: EAST
134: GUY	188: WELL	504: TELE. PEDESTAL	718: WEST
135: HEDGE	189: WM	505: CATCH BASIN	719: ROW MARKER
136: SHRUB	190: WV	506: FUEL SHUTOFF	720: P.K. NAIL
137: BUSH	191: WHL CH RAMP	VALVE	721: FND 1/2 IRON PIN
138: INLET	200: WE\WS	507: SPRINKLER VALVE	790: 1/2" rebar
139: CB	201: WE/WS	508: WATER VALVE	801: REF.TREE
140: AC ISL	202: SOUNDING	509: ELECTRIC BOX	802: BLAZED REF TREE
141: CONC ISL	203: CL FLOW	510: GUY WIRE	803: BOAT SPIKE
142: JUNC BOX	204: SILT SOUNDING	511: LITE POLE	804: R.R. SPIKE
143: LAKE	205: THALWAG	512: GAS PUMP	805: NAIL
144: EOW	206: CENTER LEVEE	513: POWER POLE	806: REF.TREE
145: LAWN	207: SHLD LEVEE	W\NAIL&TAB	W\NAIL&TAB
146: LOOP	208: TOE LEVEE	514: OBSERVATION	807: REF.TREE
147: LITE P	300: FIGURE STO	WELL	W/TAB&NAIL
148: ML BOX	301: EDGE RD	515: ELEC. LINE	811: turn
149: MON BOX	302: CL ROAD	516: NAT. GAS LINE	901: VERT WALL
150: MH SEW	303: TOP CURB	517: TEL. LINE	902: CORNER BLDG
151: MH STRM	304: FLOW LINE	518: STORM SEWER	903: BLDG
152: MH TEL	305: EDGE CONC.	519: CABLE LINE	904: RADIO TOWER
153: MH ELEC	306: EDGE SIDEWALK	520: WATER LINE	905: WATER TOWER
154: MARSH	307: CONCRETE	521: SAN. SEWER	906: FLAG POLE

907: SIGN	912: GUARD RAIL POST	918: CHECK POST	991: corn.ramp/top conc.
908: RETAINING WALL	913: FENCE COR POST	919: LOCK CRANE	992: ed.conc.ramp/clrr trks
909: CORNER CONC.PAD	914: PP ANCHOR	920: VENT PIPE	993: corner Sidewalk
910: PEDESTAL CAMP GRILL	915: SIGN POST W/NAIL&TAB	921: EDGE LOCKWALL	
911: GARBAGE CAN HOLDER	916: MAILBOX	922: E.O.BLOCK PLANTER	
	917: SINK HOLE	990: corn.refrig.unit	

F-6. Descriptor Codes (Rock Island District)

Topo Code	Description	Group			
				Rocks/Boulders	
			VV	Void Point	Misc
			VV*	Void Point	Misc
BC	Bldg Corner	Building			
BF	Building Face	Building			
BO-*	Building Opening/Doorway	Building	GLT	Ground Light	Power
			GUY	Guy Wire	Power
CMN	Column	Building	LP	Light Pole	Power
DECK	Decks	Building	OH	Overhead Wire	Power
FF	Finish Floor Elevation	Building	PP	Power Pole	Power
PORCH	Porch	Building	PRSR	Power Riser	Power
			UGVP*	Vault-Under Ground Power	Power
CP	Control Point	Control/Found			
FD	Found Monument	Control/Found			
			CL	Center Line	Roads/Walks
FNC	Fence Line Corner	Fences/Gates	EA	Edge of Asphalt	Roads/Walks
FNL	Fence Line	Fences/Gates	EC	Edge of Concrete	Roads/Walks
GP	Gate Post	Fences/Gates	EDR	Edge of Dirt Road	Roads/Walks
			EG	Edge of Gravel	Roads/Walks
GM	Gas Meter	Gas	EW	Edge of Sidewalk	Roads/Walks
GV	Gas Valve	Gas	GRDRL	Guard Rail	Roads/Walks
			GRV	Top of Gravel	Roads/Walks
DAY	Daylight (Top=Toe)	Ground/Walls	GUT	Gutter	Roads/Walks
GB	Grade Break	Ground/Walls	PATH	Path (Specify!)	Roads/Walks
GS	Ground Shot	Ground/Walls	RR	Railroad Tracks	Roads/Walks
STEP	Step (Specify!)	Ground/Walls	TCG*	Top of Curb (Curb and Gutter Combo)	Roads/Walks
STEP*	Steps (Specify!)	Ground/Walls	TCS*	Top of Standard Curb	Roads/Walks
TOE*	Toe of Slope	Ground/Walls	TP*	Top of Pavement	Roads/Walks
TOP*	Top of Slope	Ground/Walls	XCG*	Extruded Curb Shot at Gutter	Roads/Walks
WET*	Wetland Flagging	Ground/Walls			
WOE*	Toe of Wall	Ground/Walls			
WOP*	Top of Wall	Ground/Walls			
			SSCO	Sanitary Clean Out	
BEN	Bench	Misc	SSMH	Sanitary Manhole	Sanitary
BOL	Bollard	Misc			
LOG	Log	Misc	AD	Area Drain	Storm
M-	Misc. (Specify!)	Misc	CB	Catch Basin	Storm
MB	Mailbox	Misc	CI	Curb Inlet	Storm
P-	Play Ground Equipment	Misc	FL	Flow Line	Storm
PICB	Picnic Table	Misc	IE	Invert Elevation	Storm
ROCK	Large	Misc	RD	Roof Drain	Storm
			RIPRAP	Rip Rap (Outfalls)	Storm

EM 1110-1-1005
1 Jan 07

STMH	Storm Manhole	Storm			ing
			BUSH ##	Bush ## (dia. Feet)	Trees/Landscap ing
SPDB	Speed Bump	Taffic			
SGN	Sign-Misc	Traffic	EL	Edge of Landscape	Trees/Landscap ing
SGNSP	Sign-Speed	Traffic	TRC##	Coniferous Tree (##=size in inches)	Trees/Landscap ing
SGNST	Sign-Stop	Traffic			
SGNY	Sign-Yield	Traffic	TRD##	Deciduous Tree (##=size in inches)	Trees/Landscap ing
SIGB	Signal/Junction Box	Traffic			
SIGP	Traffic Signal Pole	Traffic	CO	Unknown Clean Out	Unknown Utilities
SIGX	Ped Pole w/ Button	Traffic			
TS*	Traffic Striping Misc.	Traffic	MH	Unknown Manhole	Unknown Utilities
TSA*	Traffic Arrow	Traffic	PAINT	Misc Paint Markings	Unknown Utilities
TSDW*	Traffice Stripe Dashed White	Traffic	RSR	Riser-Unknown	Unknown Utilities
TSDY*	Traffic Stripe Dashed Yellow	Traffic	STP	Stand Pipe- Unknown	Unknown Utilities
TSSW*	Traffic Stripe solid White	Traffic	U*	Misc. Utility- Unknown	Unknown Utilities
TSSY*	Traffic Stripe Solid Yellow	Traffic	UGVU*	Vault-Under Ground Unknown	Unknown Utilities
##ALD_*	Alder	Trees/Landscap ing	PNCTV	Cable TV Paint	Utilities
##ASH_*	Ash Tree	Trees/Landscap ing	PNG	Gas Paint	Utilities
##BIR_*	Birch	Trees/Landscap ing	PNP	Power Paint	Utilities
##CED_*	Cedar	Trees/Landscap ing	PNSS	Sanitary Paint	Utilities
##COT_*	Cotton	Trees/Landscap ing	PNST	Storm Paint	Utilities
##DF_*	Doug Fir	Trees/Landscap ing	PNT	Telephone Paint	Utilities
##HOL_*	Holly	Trees/Landscap ing	PNW	Water Paint	Utilities
##MAP_*	Mapple	Trees/Landscap ing	TRSR*	Telephone Riser	Utilities
##OAK_*	Oak	Trees/Landscap ing	TVRSR*	Cable TV Riser	Utilities
##PIN_*	Pine	Trees/Landscap ing	UGVT*	Vault-Under Ground Telephone	Utilities
##SPR_*	Spruce	Trees/Landscap ing	ASP	Auto Sprinkler (FDC)	Water
##UC_*	Unknown Conifer	Trees/Landscap ing	FH	Fire Hydrant	Water
##UD_*	Unknown Deciduous	Trees/Landscap ing	SH	Sprinkler Head	Water
##WIL_*	Willow	Trees/Landscap	SV	Sprinkler Valve	Water
			UGVW*	Vault-Under Ground Water	Water
			WELL*	Well-Water	Water
			WM*	Water Meter	Water
			WV*	Water Valve	Water

EM 1110-1-1005
1 Jan 07

BUSH ##	Bush ## (dia. Feet)	RSR	Riser-Unknown	PNW	Water Paint
EL	Edge of Landscape	STP	Stand Pipe-Unknown	SH	Sprinkler Head
TRC##	Coniferous Tree	U	Misc. Utility-Unknown	SV	Sprinkler Valve
TRC##_\$\$\$	Code Space Tag	UGVU	Vault-Under Ground	UGVV	Vault-Under Ground
TRD##	Deciduous Tree		Unknown		Water
TRD##_\$\$\$	Code Space Tag#			WBO	Water Blow-off Valve
		Water		WELL	Well-Water
Unknown Utilities		ASP	Auto Sprinkler	WET	Wetland
CO	Unknown Clean Out	FDC	Fire Department	WM	Water Meter
MH	Unknown Manhole		Connection	WV	Water Valve
PAINT	Misc Paint Markings	FH	Fire Hydrant		

F-7. Field Data Shots

The following excerpt is representative of the field data collected for shots 50 through 549. The observed horizontal and vertical angles are shown for each shot, along with the slope distance. The individual shots are correlated with the coded descriptor data.

=====
 FIELD DATA ENTRY AND TRAVERSE CALCULATIONS
 =====

Field Data File Log

Units of Measurement:
 Angles: DDD.mmsss Distances: Meters
 Methods of Measurement:
 Angles: DIRS Distances: EDM

```
-----
```

Rec.	Command	HZ	VT	SD	
0001	1 START	4	5	S 75 58 18.2 W	

0002	2 OCCUPY	4	1.7465		
0003	32 RADIAL	50	5		
0004	BS	00 00 00.0	91 46 36.0	74.0330	
0005	FS	50	CMP, 36"DIA, INLET INVERT		1.8288
		90 47 29.0	101 49 00.0	30.3341	
0006	FS	51	CMP, 36"DIA, OUTLET INVER		2.4384
		334 00 53.0	107 13 47.0	21.1251	
0007	FS	52	CMP, 36"DIA,OUTLET INVERT		2.4384
		338 50 48.0	106 16 54.0	22.7089	
0008	FS	53	CMP, 24"DIA, INLET INVERT		3.7490
		45 28 19.0	93 12 51.0	50.7271	
0009	FS	54	CMP, 24"DIA,OUTLET INVERT		3.7490
		11 09 04.0	95 00 54.0	44.3400	
0010	FS	55	CMP		3.7490
		94 43 27.0	98 25 40.0	29.0188	
0011	FS	56	CENTER BIKE TRAIL		1.8288
		238 28 12.0	88 52 27.0	13.5929	
0012	FS	57	CENTER BIKE TRAIL		1.8288
		232 21 20.0	88 01 59.0	3.8490	
0013	FS	58	CENTER BIKE TRAIL		1.8288
		50 53 19.0	90 11 30.0	6.1850	
.					
.					
.					
0029	FS	74	TOP BANK		1.8288
		269 31 20.0	90 15 53.0	4.8171	
0030	FS	75	TOP BANK		1.8288

0031	FS	249 32 25.0	89 29 55.0	13.9279	
		76	TOE BANK		1.8288
0032	FS	258 24 11.0	91 23 35.0	14.7310	
		77	TOE BANK		1.8288
	FS	294 25 11.0	98 28 53.0	8.6731	
.					
.					
.					
0109		151	GRD SHT		2.7737
	FS	14 23 12.0	88 13 38.0	74.5481	
0110		152	GRD SHT		2.7737
	FS	20 38 59.0	85 46 05.0	91.8291	
0304		331	CHK SHOT CP 7		1.6246
	FS	359 59 58.0	93 50 27.0	34.7241	
.					
.					
.					
0233		548	GRD SHT		5.8000
	FS	187 08 40.0	100 04 26.0	98.8290	
0234		549	CHK SHOT CP 10		5.0000
	FS	58 31 36.0	88 40 11.0	135.4920	

EM 1110-1-1005
1 Jan 07

The plate below is a sample topographic field log sheet for 28 January 1997. This sheet covers Points 447-473 that were observed from a radial setup. The Pentax total station was set at Point 11 and backsighted on Point 8, with HI/HRs measured and recorded as indicated on the form. Feature codes are recorded in groups, e.g., Top of Bank (code 102) observed from Point 447 through 453, etc. The prism height (HR) is recorded in the "Comments" column, e.g., "8.00 ft."

DATE	1-28-98	INSTRUMENT #	11 SLACITT	TEMP	40	BARR	30.00	P.P.M.	-0.11	WEATHER	P.C.	PAGE	2 OF 5
CHD BY		DATE		INSTRUMENT #	PENTAX	TEMP	40	BARR	30.00	P.P.M.	-0.11	WEATHER	P.C.
LOCATION OF SURVEY	SAYLORVILLE LAKE - RED FEATHER					TYPE OF SURVEY	TOPO						
DETAILS	JOB NAME: RDTHRZ												
LOCATION		H.I.	POINT #	DESCRIPTION									
A@	721	5.68	11	5/8" REBAR									
B/S	721	5.48	8	P-K NAIL									
C/S													
F/S													
FIRST C/S	POINT #	HORIZONTAL ANGLE		SLOPE DIST.	ZENITH ANGLE								
	-												
	-												
	-												
LAST C/S	-												
POINT #	POINT #	PCODE		COMMENTS	POINT #	POINT #	PCODE		COMMENTS				
FROM	TO				FROM	TO							
447	453	102		TOP BANK 8.00					PT	HR			
454	460	102		TOP BANK 8.00									
461	467	104		6 DITCH 8.00									
468	472	101		CRD SHT. 8.00									
473		721		CP 8 5.48									

F-8. Final Coordinates of Observed Points

The following file is a portion of the final control and topographic points observed on the project. Points 50 through 549 are the topographic shots observed from various radial points. A file such as this can be imported into MicroStation for generating the final drawing.

	<u>X-Y-Z (FEET)</u>			<u>X-Y-Z (METERS)</u>			<u>DESCRIPTOR</u>
REF. CONTROL							
1	624992.18	1955427.99	883.88	190497.997	596015.643	269.407	CP1,SV127.1A 1965
2	627014.12	1955452.98	884.54	191114.286	596023.260	269.608	CP2,SV130.1A 1966
CONTROL							
3	625810.26	1955570.39	905.55	190747.348	596059.046	276.012	CP3,SET 12"NAIL
4	626101.32	1955291.88	889.37	190836.065	595974.155	271.081	CP4,SET PK@BKETRL CL
5	626042.48	1955056.34	882.47	190818.128	595902.365	268.977	CP5,SET12"NAIL
6	626052.86	1954839.40	899.70	190821.294	595836.242	274.229	CP6,SET12"NAIL STUMP
7	626212.78	1954806.48	913.59	190870.036	595826.206	278.463	CP7,SET 12"NAIL
8	626309.37	1954746.55	920.88	190899.477	595807.940	280.685	CP8,SET PK@CL TRAIL
9	626267.99	1954950.83	908.95	190886.865	595870.204	277.049	CP9, SET 12"NAIL
10	626350.63	1954843.51	912.86	190912.053	595837.493	278.240	cp 10, set 5/8"rebar
11	626506.80	1954346.73	926.82	190959.655	595686.075	282.495	cp 11, set 5/8"rebar
12	626294.23	1954113.58	926.24	190894.862	595615.012	282.319	cp 12, set 5/8"rebar
TOPO							
50	626196.15	1955269.57	868.72	190864.967	595967.357	264.786	CMP,36"DIA,IN INVT
51	626058.76	1955241.17	866.57	190823.092	595958.702	264.131	CMP,36"DIA,OUT INVT
52	626060.12	1955233.42	866.21	190823.505	595956.339	264.022	CMP,36"DIA,OUT INVT
53	626188.00	1955150.11	873.47	190862.486	595930.946	266.234	CMP,24"DIA,IN INVERT
54	626094.05	1955147.14	870.08	190833.848	595930.041	265.202	CMP,24"DIA,OUT INVT
55	626194.26	1955276.65	868.85	190864.393	595969.514	264.825	CMP
56	626070.10	1955323.71	889.98	190826.549	595983.858	271.265	CENTER BIKE TRAIL
57	626093.50	1955301.78	889.53	190833.679	595977.173	271.130	CENTER BIKE TRAIL
58	626113.50	1955275.64	889.03	190839.775	595969.207	270.978	CENTER BIKE TRAIL
.							
.							
540	626279.55	1955088.02	886.62	190890.388	595912.020	270.243	TOP BANK
541	626300.92	1955065.22	891.77	190896.904	595905.071	271.812	TOP BANK
542	626332.37	1955044.49	893.46	190906.487	595898.751	272.327	TOP BANK
543	626320.32	1955024.22	895.30	190902.814	595892.575	272.887	GRD SHT
544	626310.18	1955007.02	896.35	190899.726	595887.332	273.208	GRD SHT
545	626278.48	1955025.74	895.52	190890.061	595893.038	272.955	GRD SHT
546	626257.64	1955037.90	894.71	190883.712	595896.745	272.709	GRD SHT
547	626277.72	1955066.91	891.27	190889.831	595905.587	271.660	GRD SHT
548	626291.18	1955045.33	891.64	190893.933	595899.008	271.773	GRD SHT
549	626350.63	1954843.50	912.88	190912.053	595837.490	278.245	CHK SHOT CP 10

F-9. Final Drawing Details

The following plates show the eastern and western portions of the survey area. The primary control traverse points CP 4 through CP 12 are shown. Invert elevations are indicated for various culverts crossing the bike trail. Ground shots used to delineate the topographic contours are shown by red "+" signs.

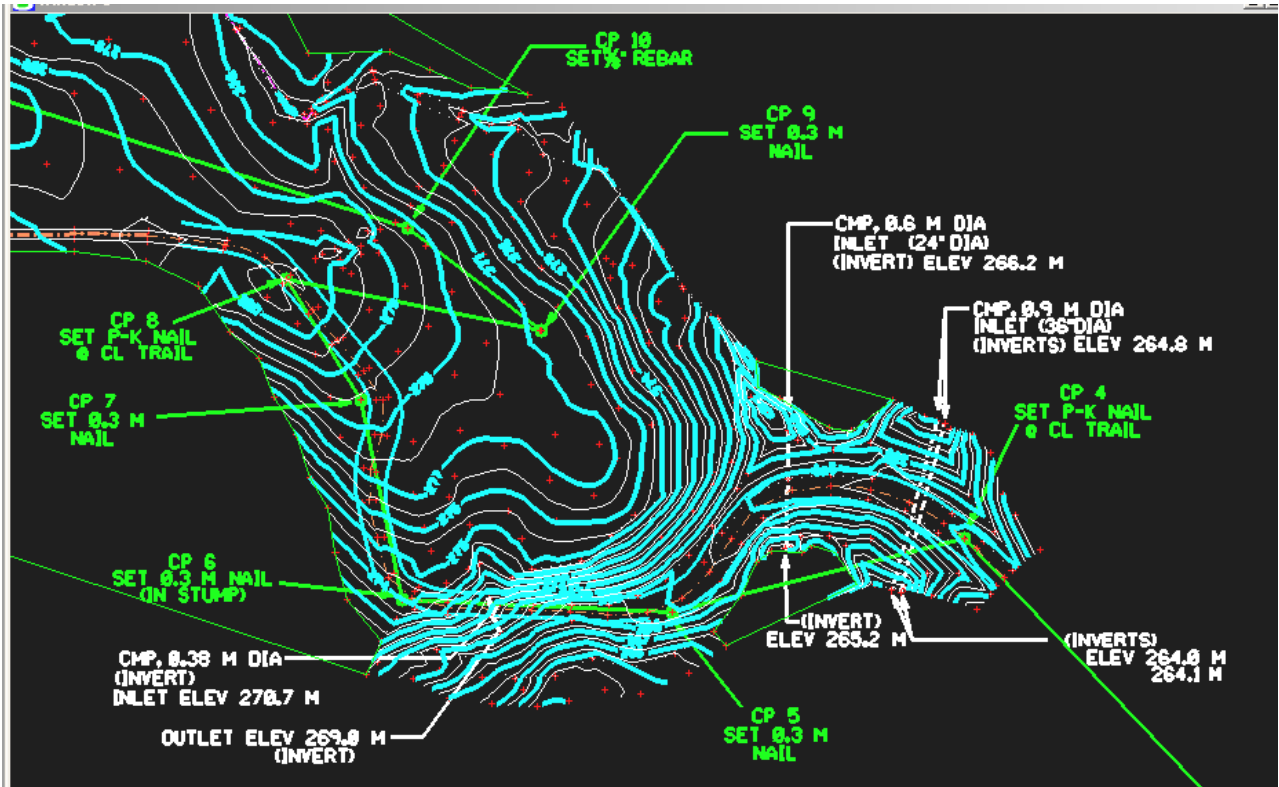

Figure F-4. Eastern portion of survey area



Figure F-5. Western portion of survey area

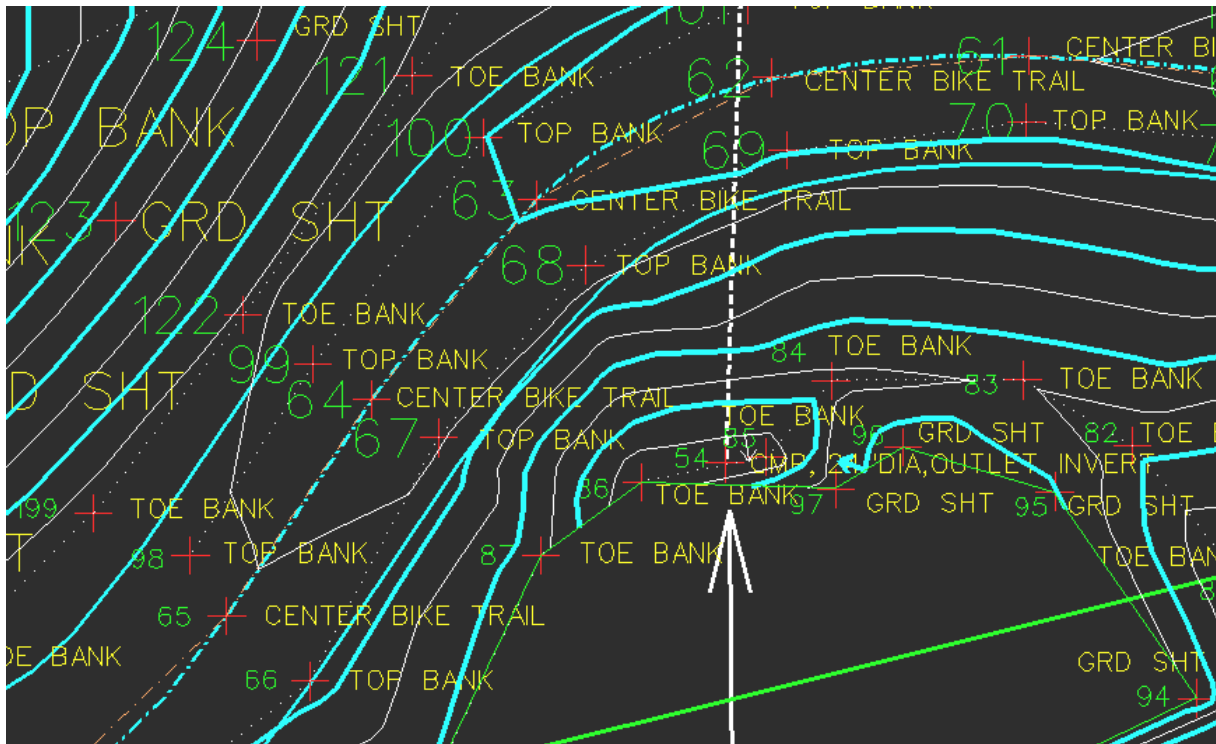

Figure F-6. Screen capture detailing point numbers and descriptors, breaklines, culvert alignment, and trail centerline

Appendix G

Application: Topographic Survey of Hannibal Lock & Dam Proposed Nationwide DGPS Antenna Site (Pittsburgh District)

G-1. Purpose and Background

This survey was performed in 1999 by GRW Aerial Surveys, Inc. under a Task Order issued by the Pittsburgh District Survey Section. The survey was conducted for site plans to be used in design and construction of a proposed US Coast Guard Nationwide DGPS 300 ft antenna, including auxiliary utilities and facilities. The proposed 30-acre \pm site was on Corps-owned land adjacent to Hannibal Lock & Dam along the Ohio River. The site plan feature and topographic detail mapping was compiled at a target scale of 1"= 50' and a 1 ft contour interval. Utility mapping was also performed. A total station, RTK, and digital level were used during this project. Field digital data were initially processed in Terramodel, and then exported into both AutoCAD and MicroStation for different users (Tennessee Valley Authority, US Coast Guard, and USACE; all of whom were involved on this project). The overall survey effort performed by GRW is depicted on the following plate and described in their "Quality Control Certification" report in the following section.

G-2. GRW Survey Report

**U.S. ARMY CORPS OF ENGINEERS - PITTSBURGH DISTRICT
NDGPS SITE SURVEY, HANNIBAL LOCKS & DAM
CONTRACT NO. DACW59-97-D-0005 DELIVERY ORDER NO. 35**

QUALITY CONTROL CERTIFICATION

CONTRACTOR: GRW Aerial Surveys Inc.
801 Corporate Drive
Lexington, Ky. 40503
(606)223-3000

SCOPE OF SERVICES:

To provide a detailed map of Tract 113 as delineated on "Exhibit A" attached to the original scope of work. Said map to meet ASPRS, Class I Map Accuracy Standards for a 1"=50' map with a 1' contour interval and to include buildings, trees, roads, sewer service lines, surface & subsurface utility systems e.g. communication, gas, water, electric, telephone, storm drainage features and structures. Said map to be tied horizontally to the NAD 27 West Virginia SPCS North Zone and vertically to the NGVD 29 vertical datum. Control monument coordinates, elevations, and descriptions for existing Corps of Engineers monumentation in the vicinity of the project were provided by the contracting officer.

To set new control monumentation on the site, outside the construction limits. The survey is to meet or exceed Third Order--Class I, with a relative accuracy of 1:10,000.

To research, survey, and monument the Ohio DOT right-of-way adjoining Tract 113 for the New Martinsville Bridge approach to Ohio Route 7 and Ohio Route 7. Said survey to be performed by a Professional Land Surveyor, licensed in the state of Ohio.

PERSONNEL:

- *Ed Rinehart - Project Manager*
- *Mark Wilmoth - Ohio PLS responsible for the research, survey, computations and staking of the Ohio DOT right-of-way.*
- *Herb Yancey - Survey Party Chief responsible for the collection of the field data used to stake the right-of-way, generate the map, and establish new on site monumentation.*
- *Ray Footland - Instrument man/field survey crew member.*
- *Wolfgang Ziegler - Computations, quality control, and map preparation.*
- *Donna Pizzuto - Map format conversion from AutoCAD to Micro station.*

DATES OF FIELD SURVEY:

SURVEY START DATE - September 13, 1999

SURVEY END DATE - September 16, 1999

EQUIPMENT:

Trimble 4000ssi dual frequency GPS receiver equipped with the RTK out option, used in conjunction with a Trimble TRIMMARK II radio modem as a RTK base station.

Trimble 4800 dual frequency GPS receiver equipped with an internal radio modem in conjunction with a Trimble TSC1 Data Collector/Controller as a RTK rover.

Leica 2002 digital level with a 3 piece fiberglass barcode level rod.

Topcon GTS 303D digital total station used in conjunction with the aforementioned Trimble TSC1 Data Collector/Controller.

PRIMARY CONTROL:

MARTINSVILLE - NGS Third order horizontal/First order vertical

HR1/14 - COE horizontal & vertical

HR1/15 - COE horizontal & vertical

SECONDARY CONTROL:

PEDESTAL MONUMENT - Found on site

METHOD - FIELD:

RTK (Real Time Kinematic GPS) surveying techniques were selected as the primary means of collecting horizontal coordinates and elevations for all aspects of this project.

The base station was initially set up on NGS station MARTINSVILLE. From there coordinates were established at the Pedestal Monument and numerous iron pins (pertaining to property boundaries), lead plugs, new monumentation, and site features (utilities, drainage features...).

The base station was then moved to the Pedestal Monument. From the setup most of the topographic data was collected. In addition some of the monuments observed from the initial setup at MARTINSVILLE were reobserved.

The field personnel noticed some inconsistency in the elevations obtained at some of the stations that were reobserved. The base station was moved back to the NGS Station MARTINSVILLE. From this setup a number of the monuments observed in the two prior setups were observed again. In addition, the right-of-way was monumented.

As an additional check of the right-of-way monumentation, the Topcon total station was used to reobserve the right-of-way monuments, radially from other stations previously controlled via RTK.

A differential leveling loop was run from a COE Bench Mark stamped BM1-631 found at the base of a flagpole. An elevation of 636.57 was verbally given to the field personnel by the Lock Master. Said loop passed through the Pedestal Monument, COE monuments HR1/14, HR1/15, M-8, and two other monuments that had multiple RTK observations.

All field work involving the resurvey and monumentation of the right-of-way was performed under the direct (on site) supervision of Mark Wilmoth.

METHOD - OFFICE - DATA REDUCTION:

Upon the return of the field personnel the digital level and TSC1 Data Collector/Controller were downloaded. The field personnel expressed their concerns regarding the elevation variations. This led to an in depth examination of the raw RTK data. It was found that in some instances the antenna types and method of instrument height measurement had been incorrectly keyed into the TSC1. The raw data file was edited and then reprocessed using Trimble's Tsoffice Software.

The field personnel didn't have a Geoid model data file with them at the time the data was collected. The Geoid 96 geoid model was incorporated during the reprocessing.

The data was initially processed in NAD 83/NAVD 88. It was then converted to NAD 27/NGVD 29 using the COE software CORPSCON.

The differential leveling data was initially reduced using the elevation provided verbally by the Lock Master for the bench mark BM 1-631 as the starting point. The elevations thus derived were compared with the published elevations for stations HR1/14 and HR1/15 provided by the contracting officer. A variation of 0.10' was noted. The level loop was re-reduced using HR1/14 as the starting BM.

The RTK derived NAD 27/NGVD 29 coordinates for COE stations HR1/14 and HR1/15 were compared with the COE published values. A slight variation was noted both horizontally and vertically. The RTK coordinates were translated, rotated, and shifted vertically to bring them into conformity with the published COE values.

MAP GENERATION:

Once satisfied with the surveyed coordinates, they were imported into TERRAMODEL for contour generation. Break lines along grade breaks were used to control contour generation. The contours were exported from TERRAMODEL into a DXF file which was imported into an AutoCAD drawing. A DXF file was created for the surveyed coordinates and also imported into said drawing. Mark Wilmoth created an AutoCAD drawing containing the right-of-way information, it was inserted in said drawing. The map was completed with the addition of annotation, border, and grid.

The completed map was visually inspected by the field personnel and found to be an accurate representation of site.

The completed drawing was e-mailed to the TVA on the afternoon of Wednesday Sept. 29, 1999 and also to the contracting officer on Thursday Sept. 30, 1999. After review, suggested edits were made and it was converted to MicroStation format for final delivery.

CONCLUSION:

When properly implemented the RTK system used in this survey is proven to rapidly and economically provide accurate coordinates at a 2 centimeter level of precision, adequate to the requirements of this project. Errors were found in the data collection but are believed to have been corrected. Unless undetected blunders or systematic errors still exist, the products of this survey meet or exceed the project requirements.

G-3. Scope of Work

The following Scope of Work was developed by the Pittsburgh District and forwarded to GRW with a letter Request for Proposal.

CONTRACT NO. DACW59-97-D-0005

DELIVERY ORDER NO. 0035

SURVEYING AND MAPPING SERVICES

NDGPS SITE

HANNIBAL LOCK & DAM, HANNIBAL, OHIO

SCOPE OF WORK

1. GENERAL SCOPE AND LOCATION OF WORK.

a. The contractor shall provide professional surveying and mapping and related services necessary to accomplish all items of work under this delivery order. The contractor shall perform field surveys and office support functions as required to compile and furnish to the Government a detailed site map and other exhibits suitable for use for engineering design and development of plans and specifications for the construction of a proposed Nationwide Differential Global Positioning System (NDGPS) site. The site, designated as Tract 113, is located at Hannibal Lock and Dam, Hannibal, Ohio. Final products shall be delivered in both digital and hard copy format and include all supporting data and materials developed during the acquisition and compilation process. Exhibits depicting the site location and mapping limits, control data, and other available maps and exhibits will be furnished for the contractor's use in the development of the work.

b. The contents of this scope describes the specific project requirements to be accomplished under this delivery order and the end product required of the contractor. General contract and technical specifications not covered by this scope are contained in applicable portions of the Basic Contract.

2. GOVERNMENT FURNISHED DATA AND MATERIALS. *The following data and materials will be furnished for the contractor's use in the development of the work. All original data and materials will remain the property of the Pittsburgh District Corps of Engineers and shall be returned at the completion of the work. The contractor shall be responsible for the safety of original data and materials while in his possession.*

3. CHARACTER AND EXTENT OF SERVICES. *The contractor shall perform and furnish the following items of work.*

a. General Surveying and Mapping Requirements.

(1) *General site plan feature and topographic detail mapping compiled at a target scale of 1"= 50', 1' contour interval for that area annotated on furnished exhibit. Collect all existing pertinent features, drainage characteristics, drainage structures, channels, inlets and outlets, etc. Collect all surface utility data and conduct a thorough search for evidence of subsurface utilities. An underground gas line runs through a portion of the site. Gas line markers are visible.*

(2) *Set control monumentation as required to adequately control construction layout. Monumentation shall be set in an area outside the construction limits so as not to be disturbed during construction phases. Existing control monumentation within the vicinity may be used in lieu of setting new monumentation. All control monumentation, set or found, shall be adequately described and referenced in a standard fieldbook.*

(3) *Based on information established by record and by field survey, establish and delineate on the ground, with capped re-bars and witness posts, that portion of the Ohio DOT right-of-way bounding Tract 113; commencing at the edge of the right bank of the Ohio River, thence continuing along Tract 113 and Ohio Route 7. This is a critical element that will need to be properly delineated on the ground and properly annotated on the map to ensure the site is contained within COE property. At a minimum, this portion of the field work shall be performed under the on-site direction of a Professional Land Surveyor duly registered in the State of Ohio.*

b. Map Compilation and CADD Specifications.

(1) *Final maps shall contain all topographic and planimetric features encompassed within the mapping limits. The maps shall properly depict the existing site conditions as necessary to properly support engineering design and development of final plans and specifications for construction of the site. Maps shall comply with and contain, but not be limited to the following.*

(2) *Contours shall be computer generated from a DTM established by controlling point method of breaklines and random points.*

(3) *In critical areas, specifically within the proposed location of the tower, spot elevations shall be established and shown on high points and depressions.*

(4) *Planimetric features, with descriptive data and detailed sketches as appropriate, shall include, but not be limited to: buildings; roads; sewer service lines; utility systems-surface and subsurface-including all appurtenances such as communication, gas, water, electric, telephone, overhead powerlines; storm drainage features and structures, culverts, etc. For overhead communication and power lines, give number and type of wires. Furnish class of power poles; if no class is stamped on the pole, give diameter and height of pole.*

(5) *Locate and describe (type and size) scattered individual trees.*

(6) *All Horizontal and Vertical Control shall be shown on the map relative to their true position. Primary control set to control construction phases shall be labeled as such.*

(7) *Final map compilation product shall be submitted in digital and hard copy form. Digital form shall be delivered on either a 3.5" high density disk or CD and consist of a 3-dimensional file formatted for input and operation on Intergraph MicroStation Platforms. Hard copies shall*

include 2 (two) reproducible quality grade mylars, and 1 (one) blueline print per map sheet. The contractor shall provide a digital file and 2 check plots for review prior to final submittal.

(8) Grid ticks shall be placed on the map in 5 inch intervals with coordinate values properly annotated and shown on the top and right edge of each map sheet.

c. *Survey Data.* The contractor shall deliver all original field books, prints, maps, records, transcripts, and all other materials and associated data utilized in the performance of the work.

4. SURVEYING PROCEDURES AND REQUIREMENTS.

a. *Horizontal control shall be initiated from and referenced to existing control established at the L/D project. Controlling points shall meet or exceed Third Order, Class I, Relative Accuracy of 1:10,000.*

b. *Vertical control shall be initiated from and referenced to existing Bench Marks established at the L/D project. Controlling points shall be contained within a closed level loop utilizing procedural specifications to meet or exceed Third Order Accuracy Standards. Unless otherwise directed, initiating and closing the loop on the same bench mark shall not constitute an acceptable control circuit.*

c. *Topographic surveys shall follow and meet ASPRS, Class I, Map Accuracy Standards as established for the target scale and indicated contour interval specified in subpara. 3a(1).*

d. *Total Station with automated data collection shall be considered appropriate instrumentation for performing topographic mapping. Procedural specifications shall be sufficient to meet the accuracy standards specified.*

e. *All computations shall be performed by the contractor. A copy of all files generated by computer software shall be included in the computer file. Deficiencies shall be recognized and steps to initiate corrective measures shall be taken as required.*

5. **QUALITY CONTROL AND ASSURANCE.** *All work shall be performed under adequate supervision and quality control measures. The contractor shall be responsible for implementing internal quality control and assurance measures for all phases of the work. A quality control plan shall be submitted outlining the procedures the contractor will follow to meet the technical specifications prescribed by this delivery order. Upon completion of the work, the contractor shall submit a signed quality control certification. The certification shall describe the internal review process to include the names of personnel responsible for quality assurance reviews for each phase of the work.*

6. **ACCESS TO WORK.** *Right-of-entry upon the site will be made available to the contractor. Prior to proceeding with work, the contractor shall contact and visit the Hannibal Lock and Dam office. The lockmaster at Hannibal Lock and Dam is Mr. Dave Walters, 740-483-2305. The contractor shall coordinate his activities with Mr. Walters, or designated alternate, and shall acquaint himself with safety procedures and regulations governing the facility. The contractor shall be responsible for obtaining right-of-entry upon lands not controlled or subordinated to such rights by the Government. Such entry shall be made solely for the purpose of performing the surveys prescribed by this scope. The Contractor shall assume all liability for and save the Government harmless on account of damages to persons or property in the execution of all work performed under this delivery order.*

7. *COMMENCEMENT OF WORK.* The contractor shall be prepared to commence work during the first full work week after receipt of contract award.

8. *COMPLETION OF WORK.* Completion of work shall include satisfactory performance of topographic mapping and delivery of acceptable final product, control survey field books, computations, and computer files.

9. *DELIVERY OF WORK.* All costs of deliveries shall be borne by the contractor. A letter of transmittal or shipping form, in duplicate, listing the materials being transmitted shall accompany each delivery, and being properly numbered, dated, and signed. All submittals shall be sent to:

U.S. Army Corps of Engineers, Pittsburgh District
ATTN: CELRP-ED-GM
William S. Moorhead Federal Building
1000 Liberty Avenue
Pittsburgh, PA 15222-4186

10. *SCHEDULE OF DELIVERY.* All work shall be completed and final deliverable products submitted within NLT 30 Sep 99. In the event the contractor is unable to meet completion schedules due to events beyond his control such as loss time due to inclement weather or other incurred delays, he shall submit a written request with appropriate documentation to extend the contract completion date.

11. *PROJECT COORDINATOR OR MANAGER.* The project coordinator representing the Government shall be Mr. Stephen LeBlanc, Survey and Mapping Section, 412-395-7328. Questions pertaining to survey control should be directed to Mr. Don McQuillan, Chief, Field Survey Unit, 412-395-7333.

12. *INVOICES.* The Contractor shall submit invoices for payment on a monthly basis. Payment requests shall be submitted on an ENG93. Two original copies with two original signatures are required with each request. Payment estimates shall be SUBMITTED TO MR. PHIL ORLANDO AT:

U.S. ARMY ENGINEER DISTRICT, PITTSBURGH
ATTN: CEORP-ED-DT (MR. PHIL ORLANDO)
1000 LIBERTY AVENUE
PITTSBURGH, PA 15222.

G-4. Government Cost Estimate and Contractor Cost Proposal

The following cost estimate for this Task Order was prepared by the Pittsburgh District Survey Section.

GOVERNMENT ESTIMATE OF COST				
CONTRACT NO. DACW59-97-D-0005				
DELIVERY ORDER NO. 35				
NDGPS SITE SURVEY - HANNIBAL LOCK & DAM				
Category	Task	Quantity	Unit Price	Amount
PROJECT MANAGEMENT				
Project Manager	Overall Project Management/Supervision	12 hrs	\$ 80.43	965.16
Land Surveyor	1. Project Planning	8 hrs		
	2. QC Review/Computations/Reports	16 hrs		
	Total	24 hrs	\$ 53.46	1283.04
FIELD SURVEYS				
Land Surveyor	1. Recon/On-Site Coordination-Supervision/Computations	36 hrs		
	2. Travel	12 hrs		
	Total	48 hrs	\$ 53.46	2566.08
Survey Party Chief	1. Recon/Establish Control	8 hrs		
	2. Field Surveys to Establish Site Right-of-Way	12 hrs		
	3. Field Surveys for Map Compilation	16 hrs		
	4. Travel	12 hrs		
	Total	48 hrs	\$ 36.25	1740.00
Instrument Operator	1. Recon/Establish Control	8 hrs		
	2. Field Surveys to Establish Site Right-of-Way	12 hrs		
	3. Field Surveys for Map Compilation	16 hrs		
	4. Travel	12 hrs		
	Total	48 hrs	\$ 29.65	1423.20
Map Compilation/Data Generation				
CADD Supervisor	Supervision/QC Review	8 hrs	\$ 58.59	468.72
CADD Operator	Map Compilation	40 hrs	\$ 36.20	1448.00
OTHER				
Per Diem	Field Survey Party (6 3-man party days)	18 days	\$ 80.00	1440.00
Misc. Services	Misc. Supplies and Services		\$ 100.00	100.00
			Subtotal	11434.20
			Profit 11%	1257.76
			TOTAL	12691.96

Based on the above Government Cost Estimate, the 6 day field estimate for this 1in = 50 ft scale boundary, topographic, and utility survey amounts to approximately \$425 per acre ($\$12,700 \div 30$), at a production rate of 5 acres/day. The IGE broke down the field work as follows: primary control 1.0 days, boundary (right-of-way) 1.5 days, and 2.0 days to perform the planimetric, topographic, and utility detail. Given an actual 854 shot points were taken during the estimated 3.5 days of topographic survey, this works out to roughly 250 points per 8-hour day. These rates cannot be extended to other projects since the basic components (boundary work, topographic relief, and utility detail) will vary widely from project to project.

The contractor's proposal was nearly identical to the Government Estimate. Both estimates assumed 48 hours of field survey time. The contractor proposed 4 hours time for a Project manager and 80 hours for a licensed land surveyor (vice 12 hours and 72 hours in the Government Estimate, respectively). The contractor's proposal of \$12,941 (\$249 over the Government Estimate) was accepted and the Task Order awarded for this amount. See following negotiation memorandum.

CELRP-ED-GM

1 September 1999

MEMORANDUM THRU

Chief, Geotechnical Branch

FOR Chief, Contracting Division

SUBJECT: Acceptance of GRW Aerial Surveys, Inc. Cost Proposal for Professional Surveying Services under Contract No. DACW59-97-D-0005, Delivery Order No. 35, NDGPS Site Survey, Hannibal Lock and Dam, Hannibal, Ohio.

- 1. This memorandum transmits acceptance of GRW Aerial Surveys, Inc., cost proposal to perform the Professional Surveying Services prescribed under the subject task order. The Scope of Work, Independent Government Estimate dated 1 September 1999 in the amount of \$12,691.96, and request for proposal was submitted to CT-O on 1 September 1999. In response to the ensuing RFP, GRW Aerial Surveys, Inc., submitted a proposal dated 1 September 1999 in the amount of \$12,940.74, \$248.78 above the Government Estimate. ED-GM reviewed the Contractor's proposal and all labor and non-labor categories are acceptable.*
- 2. Please initiate action to award the subject Delivery Order in the amount of \$12,940.74. Funds are available under PR&C W81ET 4924 26557. Point of contact for this action is the undersigned.*

Encl

*STEPHEN LEBLANC
Chief, Survey and Mapping Section*

G-5. Data Collector Coordinate File

The following "CR5" file is excerpted from the Trimble TSC1 Data Collector/Controller used to collect topographic data on this site. Each data point has the following format:

POINT NUMBER, X (ft), Y (ft), H (NGVD 29), FEATURE DESCRIPTOR

Coordinates are on the West Virginia SPCS North Zone (NAD 27) and elevations on NGVD 29. A total of 854 points were collected on this project. (Only selected features are shown of the 854 total points that were shot).

1, 425020.22, 1617558.18, 663.83,MARTINSVILLE	64, 425579.69, 1614544.51, 623.76,ROW 93
2, 424974.11, 1617518.56, 666.02,RM 2	65, 425302.54, 1614821.67, 627.00,ROW 94
3, 424992.50, 1617606.37, 665.91,RM 1	66, 425271.23, 1615209.86, 618.49,POL FOR ROW 95
4, 431633.86, 1611493.19,1223.17,FOUND SEC CORIPCCLAUS6456	67, 426156.87, 1614607.43, 626.63,STAKE C-5
5, 431629.01, 1611564.15,1227.54,FND IP NO ID	68, 425900.57, 1614592.24, 627.72,STAKE C-4
6, 431819.94, 1611576.81,1267.85,FND IP CLAUS	69, 425641.69, 1614555.84, 621.65,STAKE TLE-7
7, 426417.60, 1614366.02, 636.78,FND IPC CLAUS 6456	70, 425351.95, 1614631.41, 627.15,STAKE C-3
8, 426458.16, 1614104.24, 647.84,FND IPC CLAUS 6456	71, 425314.51, 1614835.75, 627.78,STAKE TLE-4
9, 426210.78, 1614068.00, 648.19,FND IPC CLAUS 6456	72, 425322.45, 1615124.01, 633.67,STAKE C-2
10, 426172.40, 1614313.38, 632.99,FND IPC CLAUS 6456	73, 425609.72, 1615158.08, 634.46,STAKE TLE-1
11, 424768.72, 1614200.14, 636.78,FND IPC BIEDENBACH	74, 425784.73, 1615140.76, 634.61,STAKE MAST-2
12, 424769.85, 1614185.44, 640.17,FND IP	75, 425863.87, 1615144.24, 633.92,STAKE MAST-1
13, 425566.02, 1614209.99, 634.57,FND IPIPE NO ID	76, 425869.77, 1615151.38, 633.69,STAKE C-1
14, 425706.06, 1614233.83, 634.44,IRON FENCE POST	77, 425849.30, 1615118.70, 633.92,STAKE EQU AREA
15, 427404.67, 1615326.78, 633.10,COE PLUG L-27	78, 425909.87, 1614874.35, 631.27,STAKE TLE-10
16, 427488.90, 1615325.18, 633.17,COE PLUG L-25	79, 425778.09, 1614907.26, 632.19,STAKE C-175
17, 427741.49, 1615320.52, 633.11,COE DISK M-7	80, 425707.21, 1614885.09, 632.10,STAKE C-100
18, 425399.12, 1614642.56, 629.46,CP IPC SET # 34	81, 425611.30, 1614854.95, 631.92,STAKE TOWER
19, 425830.81, 1614594.13, 629.11,CP IPC SET # 35	82, 425538.40, 1614922.72, 630.19,STAKE A-100
20, 426396.15, 1614577.71, 626.67,CP IPC SET # 36	83, 425482.97, 1614974.17, 630.87,STAKE A-175
21, 426310.72, 1614534.91, 623.22,DISTURBED REBAR	84, 425589.48, 1614758.57, 631.00,STAKE B-100
22, 426411.75, 1614400.42, 631.33,FOUND IPC CLAUS 6458	85, 425572.28, 1614683.48, 630.58,STAKE B-175
23, 426199.30, 1614368.06, 630.43,FOUND IPC CLAUS 6458	86, 425340.67, 1615022.17, 629.50,TB
24, 426164.26, 1614364.34, 629.64,FOUND IPC CLAUS 6458	87, 425324.53, 1615070.77, 631.90,TB
25, 424359.48, 1614144.26, 641.52,IP CLAUS BY TESTIMONY	122, 426452.73, 1614807.76, 631.08,TB
26, 424355.19, 1614144.02, 641.66,BEIDENBACH IPC 7881	129, 426795.22, 1614800.28, 631.07,GRD
27, 424235.60, 1614135.24, 643.36,BEIDENBACH IPC 7881	130, 426798.46, 1614749.29, 631.22,GRD
28, 424478.70, 1614198.06, 637.40,RF RISOR IPC 7093	135, 426772.48, 1614550.93, 631.82,GRD
29, 424462.66, 1614377.42, 624.55,CLAUS IPC 6456	136, 426833.30, 1614548.73, 631.72,DITCH LINE
30, 424460.37, 1614402.17, 623.73,CLAUS IPC 6456	137, 426806.90, 1614545.55, 631.34,DITCH LINE
31, 423972.37, 1614301.52, 625.56,CLAUS IPC 6456	138, 426782.66, 1614543.28, 631.20,DITCH LINE
32, 423970.11, 1614326.49, 624.64,CLAUS IPC 6456	139, 426723.25, 1614540.92, 630.68,GRD
33, 427997.32, 1614599.57, 637.08,CL INT 7 AND 536	197, 425507.37, 1614580.40, 626.81,GRD
34, 427567.82, 1614552.63, 635.20,CL 7	216, 426501.01, 1614623.78, 627.28,GRD
35, 427003.15, 1614494.02, 633.10,CL 7	232, 426194.67, 1614565.04, 625.38,GRD
36, 426445.87, 1614434.60, 633.43,CL 7	233, 426129.70, 1614589.51, 627.34,TB
37, 425969.93, 1614383.87, 630.62,CL 7	244, 425565.84, 1614609.06, 628.92,TB
38, 425445.17, 1614327.57, 628.80,CL 7	245, 425520.08, 1614620.02, 629.06,GRD
39, 425211.48, 1614302.48, 629.67,CL 7	397, 425713.74, 1615235.86, 616.68,TB
40, 424790.98, 1614403.10, 632.01,FACE CURB ONRAMP	398, 425781.74, 1615230.48, 616.71,GRD
41, 424961.71, 1614470.06, 637.09,FACE CURB ONRAMP	406, 425701.27, 1615209.47, 617.87,TS
46, 425175.57, 1615025.78, 663.37,CL BRIDGE	407, 425628.20, 1615208.12, 617.67,TS
47, 425196.91, 1614984.27, 661.74,FACE CURB OFF RAMP	417, 425708.73, 1615214.61, 617.24,TS
55, 425625.69, 1614482.05, 631.07,FACE CURB OFF RAMP	425, 425323.50, 1615200.70, 618.10,TS
56, 425006.79, 1617114.26, 666.24,CL BRIDGE	426, 425406.84, 1615013.75, 630.69,GRD
57, 427990.66, 1614462.40, 643.71,FND DRILL HOLE	427, 425436.22, 1615016.99, 631.67,GRD
58, 428007.24, 1614497.69, 638.90,FND PK	428, 425949.56, 1615064.81, 625.07,SLOPE
59, 428021.10, 1614316.77, 647.37,FND IPC NO ID	433, 426056.38, 1614899.52, 626.31,SLOPE
60, 428004.10, 1614286.56, 648.03,FND IP NO ID	434, 426118.43, 1614870.39, 625.73,SLOPE
61, 425982.83, 1614514.77, 621.49,ROW 92	435, 426200.95, 1614861.15, 624.78,TB
62, 425994.62, 1614522.46, 621.60,ROW 91	436, 426240.47, 1614860.22, 624.53,TB
63, 426532.18, 1614620.42, 628.09,ROW 90	437, 426286.00, 1614858.01, 625.52,TB

438,	426351.26,	1614857.85,	625.71, TB	753,	426608.03,	1614513.86,	633.32, TOB--GUARDRAIL
489,	425653.00,	1614757.14,	631.10, GRD	754,	426510.54,	1614505.47,	632.94, TOB--GUARDRAIL
490,	425624.91,	1614753.60,	631.11, GRD	755,	426413.01,	1614498.76,	631.96, TOB--GUARDRAIL
504,	425429.36,	1614659.89,	629.71, GRD	756,	426388.72,	1614502.67,	630.79, LIGHTPOLE
505,	425497.03,	1614662.04,	629.65, 12 IN TREE	757,	426306.32,	1614491.69,	630.62, TOB--GUARDRAIL
506,	425447.36,	1614659.90,	629.71, 12 IN TREE	758,	426306.32,	1614491.68,	630.62, TOB--GUARDRAIL
507,	425424.52,	1614738.42,	631.07, GRD	759,	426202.40,	1614483.18,	630.02, TOB--GUARDRAIL
508,	425439.52,	1614738.43,	631.07, 4 IN TREE	765,	425797.40,	1614478.26,	626.41, LIGHTPOLE
530,	425742.78,	1614985.84,	632.49, 15 INT REE	766,	425718.97,	1614479.63,	628.07, TOB--GUARDRAIL
531,	425768.16,	1615015.67,	632.69, 24 IN TREE	767,	425616.51,	1614492.51,	630.48, TOB--GUARDRAIL
532,	425807.77,	1614989.29,	633.51, 15 IN TREE	768,	425576.57,	1614502.21,	631.98, LIGHTPOLE
533,	425872.50,	1615049.31,	634.15, 8 IN PINE	769,	425624.85,	1614481.15,	630.87, GRATE 2X2
534,	425900.66,	1615068.51,	633.67, 8 IN PINE	770,	425492.44,	1614514.45,	635.46, TOB--GUARDRAIL
535,	425912.66,	1614996.09,	633.71, 15 IN TREE	771,	425396.39,	1614542.87,	640.03, TOB--GUARDRAIL
536,	425927.14,	1615196.78,	616.80, EDGE RIPRAP	772,	425434.34,	1614519.51,	638.83, GRATE 2X2
560,	426715.93,	1614917.75,	607.27, TOE RIPRAP	773,	425312.22,	1614603.22,	644.69, TOB--GUARDRAIL
574,	426120.81,	1614949.85,	603.41, TOE RIPRAP	774,	425262.81,	1614687.18,	649.41, TOB--GUARDRAIL
594,	425223.02,	1615260.90,	602.28, TOE RIPRAP	775,	425241.25,	1614730.71,	651.93, GRATE 2X2
595,	425334.49,	1615177.23,	625.70, GRD	776,	425238.87,	1614788.54,	653.80, TOB--GUARDRAIL
700,	426227.01,	1615147.28,	628.37, GRD	782,	425193.36,	1615020.39,	663.68, TOB--GUARDRAIL
701,	426213.68,	1615178.35,	628.04, 10 IN PINE	783,	425193.40,	1615026.76,	663.94, BRIDGE CORNER
702,	426214.83,	1615180.57,	628.16, GRD	784,	425191.66,	1615011.12,	662.48, GRATE 2X2
703,	426226.83,	1615180.57,	628.16, 10 IN PINE	785,	425203.41,	1615027.36,	660.03, END WING WAL2FT WIDE
704,	426220.99,	1615197.49,	628.16, 10 IN PINE	786,	425200.61,	1615021.72,	661.27, TOB
705,	426237.39,	1615172.36,	628.16, 10 IN PINE	798,	425441.16,	1614560.75,	626.50, TOE
706,	426276.41,	1615156.89,	628.67, GRD	799,	425296.03,	1614746.99,	628.55, INV 18 IN CMP
707,	426329.14,	1615156.35,	628.78, GRD	800,	425445.00,	1614558.31,	627.54, INV 18 IN CMP
708,	426353.51,	1615157.09,	628.87, GRD	801,	425444.88,	1614558.36,	626.04, INV 18 IN CMP
709,	426364.57,	1615147.12,	628.59, 8 IN TREE	802,	425547.18,	1614527.57,	624.38, TOE
710,	426405.70,	1615161.76,	628.54, GRD	803,	425704.80,	1614505.33,	620.49, TOE
711,	426429.06,	1615163.99,	628.83, 12 IN PINE	804,	425703.61,	1614511.78,	619.61, DITCH LINE
712,	426482.02,	1615161.02,	628.57, GRD	805,	425693.39,	1614504.90,	619.98, INV 30 IN RCP
713,	426535.06,	1615158.80,	628.53, GRD	806,	425780.53,	1614501.01,	620.16, DITCH LINE
714,	426583.46,	1615154.92,	628.65, GRD	807,	425783.47,	1614492.17,	620.65, TOE
715,	426588.27,	1615118.04,	627.81, GRD	808,	425826.61,	1614489.07,	620.64, TOE
716,	426582.93,	1615071.18,	627.24, GRD	815,	426181.60,	1614497.41,	622.32, TOE
717,	426540.02,	1615068.13,	627.09, GRD	816,	426276.28,	1614504.41,	623.01, TOE
718,	426488.68,	1615072.06,	627.40, GRD	817,	426277.47,	1614511.75,	622.31, DITCH LINE
719,	426432.18,	1615073.43,	627.43, GRD	818,	426382.31,	1614528.03,	622.63, DITCH LINE
720,	426378.10,	1615076.50,	627.13, GRD	819,	426386.29,	1614516.29,	623.10, TOE
721,	426383.42,	1615070.02,	627.33, 10 IN TREE	820,	426487.29,	1614541.95,	622.90, DITCH
722,	426362.17,	1615051.14,	628.14, 36 IN TREE	825,	426591.83,	1614537.12,	626.52, DITCH
723,	426322.61,	1615058.71,	627.80, 36 IN TREE	826,	426594.63,	1614533.65,	626.09, ANCHOR
724,	426283.63,	1615064.19,	628.15, 20 IN TREE	827,	426593.65,	1614532.15,	627.74, ANCHOR
725,	426271.96,	1615101.08,	627.69, GRD	828,	426595.13,	1614522.32,	629.86, P POLE
728,	426172.21,	1615075.89,	627.57, 10 IN PINE	829,	426487.59,	1614521.55,	623.47, DITCH
729,	426189.73,	1615052.44,	627.61, 18 IND BL TREE	830,	426701.78,	1614546.38,	628.72, HEADWALL CORNER
730,	426233.59,	1615051.07,	627.52, 10 IN PINE	831,	426709.29,	1614547.13,	628.74, HEADWALL CORNER
731,	426256.47,	1615056.56,	627.98, 3 6 IN APPLE TREES	832,	426712.80,	1614554.30,	628.68, HEADWALL CORNER
732,	425445.91,	1614653.63,	630.40, 12 IN TREE	833,	426708.10,	1614551.57,	624.96, INV 24IN RCP
733,	425497.77,	1614659.05,	743.06, 12 IN TREE	834,	426753.18,	1614542.71,	630.76, GRATE 2.5X3
734,	425576.15,	1614647.02,	630.61, 6 IN TREE	842,	426748.30,	1614543.59,	631.11, EDGE CONC
735,	425596.55,	1614619.53,	629.79, 12INTREE	843,	429836.04,	1614770.60,	630.79, PLUG 1-14 FND
736,	425449.31,	1614561.48,	626.12, GAS MARKER	844,	430800.45,	1614744.08,	640.65, PLUG 1-15 FND
737,	425502.63,	1614558.88,	625.50, GAS LINE	845,	428011.55,	1614675.67,	636.09, BIEDENBACH 7881 IPC
741,	425836.63,	1614532.94,	620.71, GAS LINE	846,	427752.42,	1615253.36,	636.66, BM 1-631
742,	425923.18,	1614527.63,	620.73, GAS MARKER	847,	427074.21,	1615333.09,	633.04, M-8 COE DISK
743,	426009.97,	1614526.18,	621.93, GAS LINE	848,	425532.41,	1615147.65,	637.54, PED MON
744,	426110.58,	1614535.76,	621.74, GAS MARKER	850,	426752.26,	1614616.21,	629.67, CP IPC SET # 38
745,	426251.01,	1614548.18,	624.90, GAS LINE	851,	425650.33,	1614531.03,	621.61, WING WALL
749,	426712.38,	1614671.40,	629.70, GAS MARKER	852,	425652.76,	1614511.07,	624.56, HEADWALL COR
750,	426715.77,	1614527.03,	632.74, TOB	853,	425645.45,	1614522.77,	624.66, HEADWALL COR
751,	426675.88,	1614522.12,	633.04, TOB	854,	425647.16,	1614520.11,	618.52, 56 IN RCPINV
752,	426637.86,	1614518.70,	633.14, TOB--END GUARDRAIL				

G-6. Samples from Final CADD Output Drawing

The AutoCAD screen capture below depicts a portion of the Terramodel generated contours at the northwestern region of this site. The red contours are at 5-ft intervals, with the blue at intermediate 1-ft intervals. The ground shot data from which a DTM, TIN, and contours were generated are not shown on the final plan in this view--occasional spot elevations are shown in low gradient areas. Ground shots were taken about every 40 to 50 ft in low gradient areas, and denser along breaklines and high relief. The underground gas line is indicated by the "G" line just east of the right-of-way line. Trees are symbolized using a standard library symbol as shown. Trees in this area were attributed by diameter only--the species of each individual tree could have been attributed had this been required in the original Scope. Pine trees were differentiated by symbology. Light poles within the road right-of-way are symbolized by an "L" in a circle. Inverts on culverts are indicated by leader arrows.

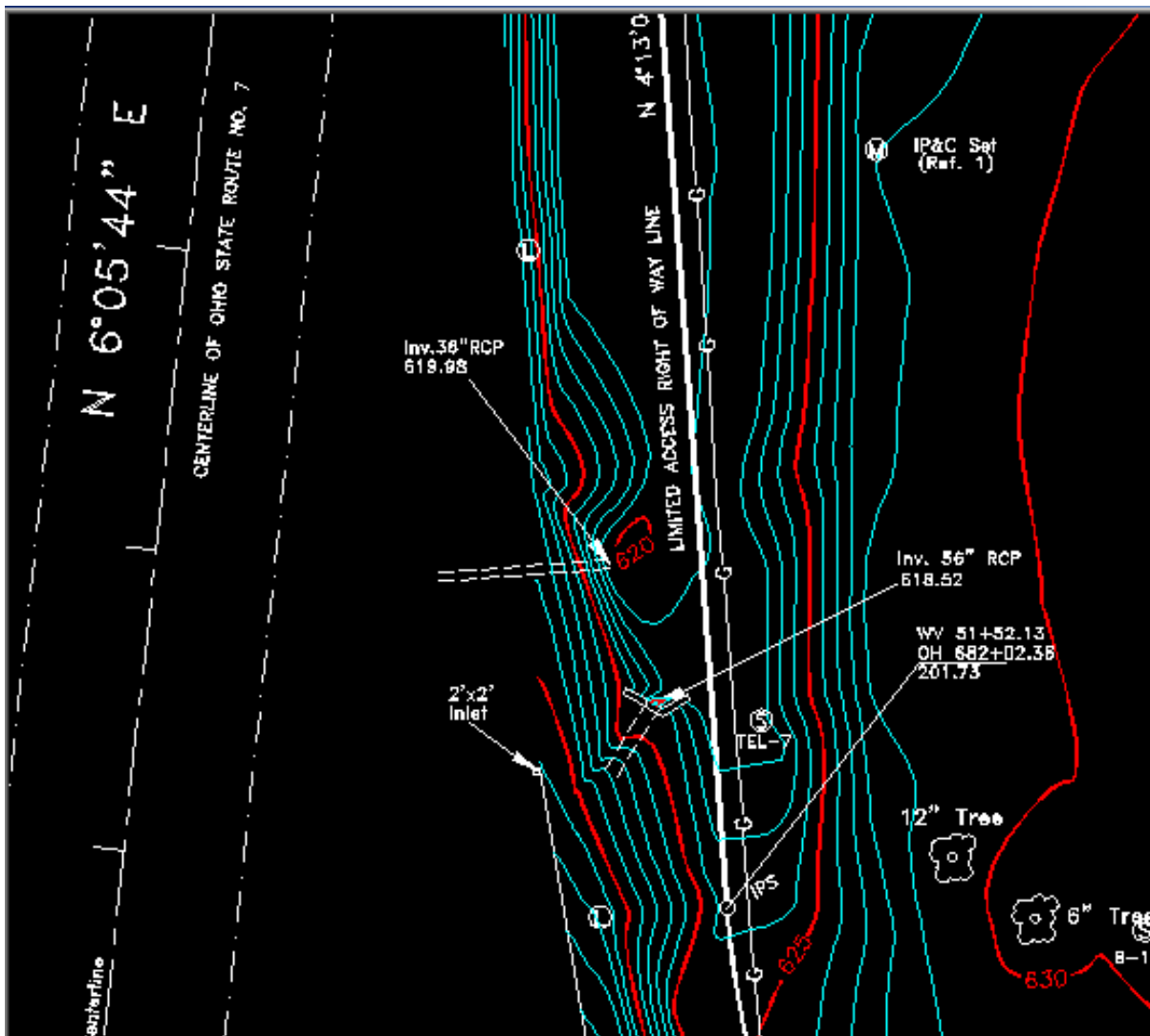

(Note: Autodesk and AutoCAD are registered trademarks of Autodesk, Inc., in the USA and other countries. Certain images used with permission of Autodesk, Inc. © 2001-2003. All rights reserved.)

The following MicroStation screen capture depicts the symbology used for various features. A portion of the CR5 data collector file shows the origin of the points--e.g., the 3 6-in apple trees are shot number 731. The ground elevation of the trees is not shown since it can be interpolated from the contours. If needed, these elevations are in the database.

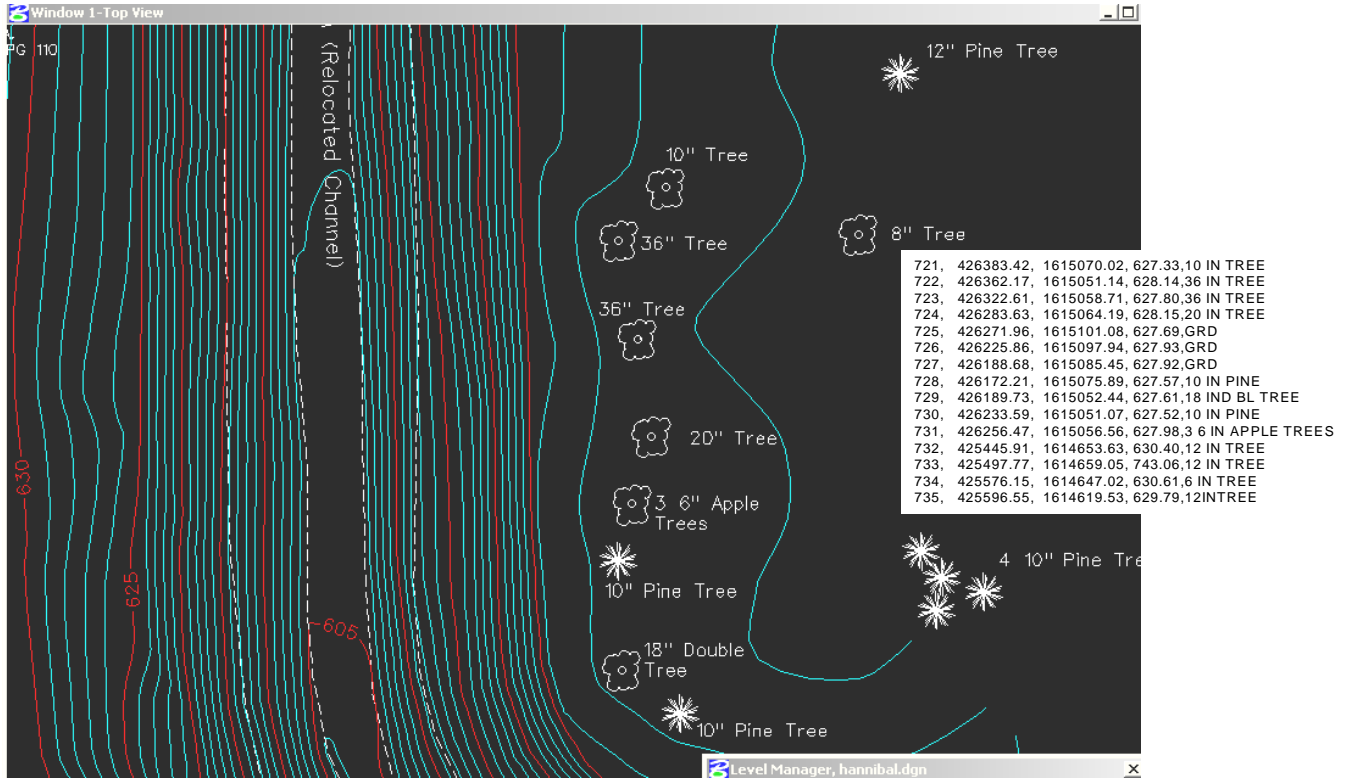

The following AutoCAD screen capture shows the note block indicating the horizontal and vertical datums, and the date of survey. The lock and dam monitoring pedestal monument (M-15) is indicated at the top center. This point was used as a base for much of the radial topography shot at the site.

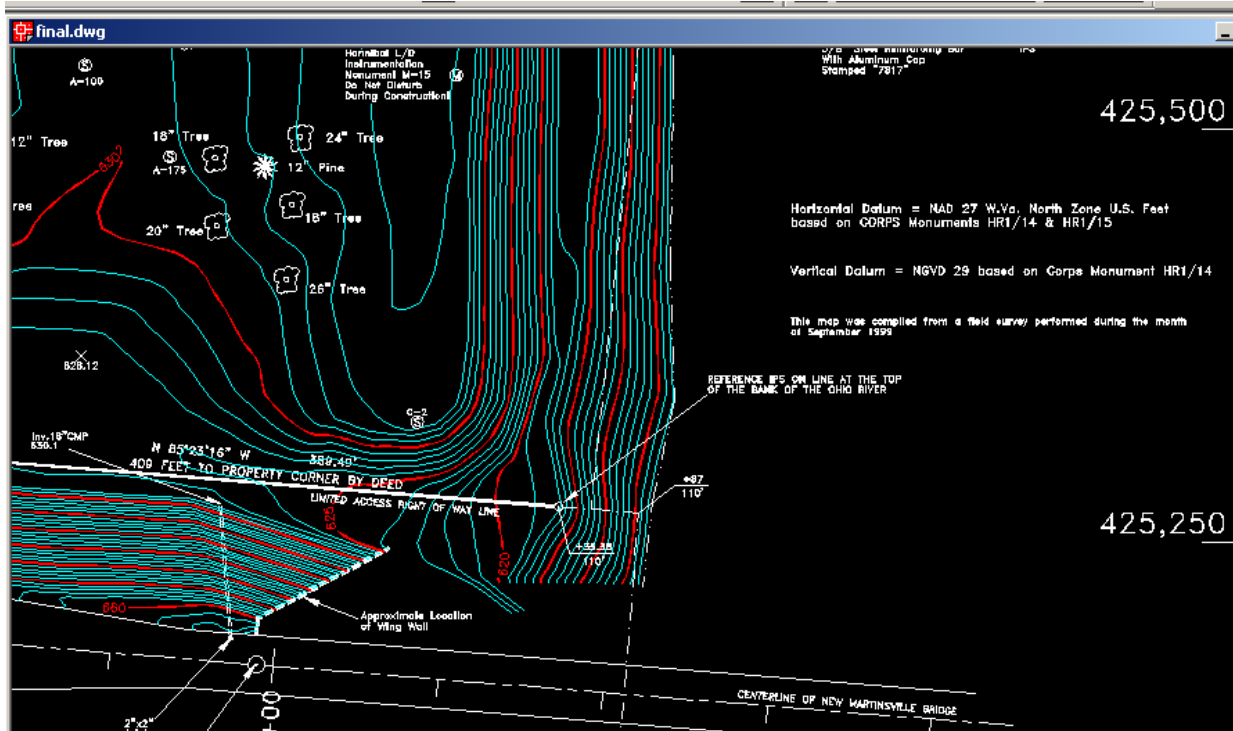

Appendix H
Application: Topographic and Planimetric Survey--Proposed Military Fitness Center (Tulsa District)

H-1. Purpose and Background

This topographic survey of a proposed fitness center at a military base in Oklahoma was performed under a Tulsa District contract in 2002. It entails typical planimetric and topographic work over a 10 acre \pm site, with extensive above ground and underground utility detailing. The project was controlled relative to existing installation control. The horizontal datum was NAD 83 (Oklahoma North Zone) and the vertical datum was NGVD 29. The target/drawing scale was 1:200, or 1 inch = 16.67 ft. Ground elevations were shot at a 15 m (50 ft) grid spacing and final drawings were delivered in metric format with a 0.25 m contour interval. The Scope of Work below was developed by the Survey Section in the Tulsa District. The contractor who performed the survey was Entz Engineering-Huffman Surveying.

H-2. Scope of Work

CONTRACT NO. DACW56-01-D-1005

TASK ORDER NO. 32

PROPOSED FITNESS CENTER

TOPOGRAPHIC & PLANIMETRIC SURVEY

SCOPE OF WORK

11 FEB 02

I. Scope and Location

A. The intended purpose of this Task order is to obtain a product defining the topographic & planimetric layout of the area known as the Proposed Fitness Center at the site shown on the Government furnished maps. The contractor's effort toward this purpose shall yield a total field-to-finish information package, complete in detail and within the parameters defined by this scope of work, readily available for use by the Government or its agents.

B. The contents of this scope describe specific project requirements to be accomplished under this task order and the end product required of the contractor.

II. Materials Furnished by the Government. The contractor shall be provided with:

A. Site maps indicating the areas to be surveyed.

B. Existing primary survey control description sheets

III. Character and Extent

The general scope of services, specific descriptions, and technical requirements pertaining to the work required of the contractor are outlined below.

IV. Site Specifics for the Fitness Center Area

A. Survey Procedures and Standards.

Appropriate instrumentation and procedures shall be selected to obtain precision requirements necessary to meet or exceed the accuracy standards described below. Total station and GPS shall be considered appropriate for performing the survey. Sufficient control shall be distributed throughout the survey to allow horizontal and vertical positioning to be checked for compliance with stated accuracy standards. The contractor shall use a field crew experienced in performing the surveys as outlined in the scope of work and capable of responding to and completing work assignments within the critical time schedules allotted for this project. All field data acquired in establishing control points shall be illustrated in the field book.

B. Details Required for the Field Survey

1. Survey Control

a. Horizontal Control shall be relative to Oklahoma State Plane Coordinates, NAD83 expressed in Metric Units and based upon specific site control information provided by the Corps of Engineers. Controlling points shall be occupied points, with all angles observed for the closing azimuth and closed and adjusted traverses that will meet or exceed Third Order, Class I Accuracy of 1:10,000. If electronic data collectors are not used, all angular and linear measurements shall be entered into the field book at the time of observation. Latitude and departure computations, both raw and adjusted, shall be submitted to the survey section at the completion of the fieldwork. Computations shall be in a format that will allow government approval and satisfy minimum requirements as specified in the scope of work. Deficiencies shall be recognized and steps taken to obtain additional survey data as required.

b. Vertical Control shall be based on National Geodetic Vertical Datum (NGVD29) expressed in Metric Units based on closed and adjusted level loops that will meet or exceed Third Order. Elevations shall originate and close on benchmarks approved by the government. In addition, level loops shall originate on one benchmark, but be checked into another, separate benchmark.

c. New control stations shall consist of ½" Rebar having a length of 18" and a stamped aluminum cap be set. Each cap shall be identified by designation and the year set. Each control marker shall be referenced with at least three ties and appropriately described on SWT 598 forms for future use. Proper care shall be taken when setting these control points and at least a 2' radius around the control marker site shall be checked for the presence of any underground utilities.

2. Topographic & Planimetric Survey

a. The contractor will locate sufficient topographic and planimetric features to adequately allow design of the proposed new structures, which shall include, but not be limited to the following:

(1) *Buildings and structures within the defined area.*

(2) *Ground surface elevations sufficient to define any contour lines (at a 0.25 meter contour interval) and spot elevations (Note: elevation shots are to be gridded at least every 15 meter intervals; hard surfaces shot to 3 mm and natural ground areas to 3 cm).*

(3) *Type, condition and width of areas of pavement or concrete (streets, parking lots, sidewalks, runways, taxiways, aprons, shoulders, bridges), as well as centerline, curb, gutter and depressed curb locations.*

(4) *Fences*

(5) *Sanitary sewer lines and structures (include pipe materials, sizes, locations, rim and invert elevations, direction of flow, service cleanouts and lateral locations). These utilities shall be shown on a separate illustration and identified by properly numbering the sketch to correspond with the utility in relation to its location and alignment to North.*

(6) *Storm sewer lines and structures (include pipe materials, sizes, locations, rim and invert elevations, direction of flow, type of inlet, catch basin, culvert, etc.) These utilities shall be shown on a separate illustration and identified by properly numbering the sketch to correspond with the utility in relation to its location and alignment to North.*

(7) *Drainage ditches and ponding areas.*

(8) *Location and size of communication and electric lines, including all transformers and number of wires or cables. Provide a detailed sketch of manholes, illustrating the size of ducts, number of wires in each duct, spacing of ducts, and distance from the floor and wall to the centerline of ducts and its alignment to North.*

(9) *Location and size of all water lines and structures.*

(10) *Location and size of all gas lines and oil/water separators.*

(11) *Any trees, type, approximate height and diameter.*

(12) *Any permanent picnic tables or other permanent structures on the site.*

b. *A thorough search shall be made for all underground utilities. Contact John Doe at the base (888) 555-1212 to arrange a utility markout. Provide sufficient notice.*

C. Survey Data and Deliverables

1. *The contractor shall furnish all original field books, records, prints, maps, computation sheets, transcripts, and associated data utilized in the performance of fieldwork. All items described above shall become the property of the government and shall be delivered to the contracting officer prior to the final payment of the contract. Except as required for the proper and efficient performance of the contract, none of such materials shall be retained, copied, or reproduced by the contractor at any time without the expressed permission of the contracting officer.*

2. Detailed digital descriptions of all survey control, new or restored shall be furnished and illustrated on SWT 598 forms to assist in rapid recovery at a later date. The descriptions shall contain horizontal and vertical control data, a reference backsight mark with direction and distance to the mark, an appropriate to reach description, at least three reference distance and direction ties to fixed permanent figures in the immediate vicinity and a local sketch.

3. The contractor shall be responsible for preparing maps (AutoCAD 2000 *.dwg and *.dtm files) that depict all topographic features contained within the mapping limits at a 0.25 meter contour interval, showing major contour lines at 1 meter intervals and labeled accordingly as part of the package to be provided to the government. Spot elevations shall be sufficiently distributed throughout the map and shown on all high and low points to clearly define the area. In addition to the described field located features, information to be shown on the drawing shall include any details of utilities found, grid ticks based on the requested datum and labeled on the left and top of each sheet, multiple sheets shall include an index of the drawing oriented north to each sheet, north arrow and reference, contour interval shown, legend of symbols and ground control points plotted on all sheets in respect to their true positions. The map of survey shall be prepared utilizing the latest approved version of the TriService CADD Standards as found at the following site: <http://tsc.wes.army.mil/products/tssds-tsfs/tssds/projects/sds/> and a Cropsmet95 Metadata file (FGDC format) shall be prepared. In addition, an ASCII file shall be provided to the Government.

4. All materials shall be subject to inspection by the contracting officer at any time during the execution of the survey.

D. Discrepancies

The contractor shall notify the government of any discrepancies discovered in prior work or in work under contract that are not readily explainable and in such time that they may be resolved prior to the survey party leaving the field. If, at the discretion of the contracting officer work is found to be in error after the assignment is completed, the contractor shall be liable for all costs in connection with correcting the work.

V. Site Specifics of the Proposed Fitness Center

The general location of the area to be surveyed is just northeast of the Ground Safety Building #999 and bounded by the following: Sixth Street on the north, Avenue H on the east, an alley opposite Building #999 on the south and Avenue G on the West (an area approximately 500 ft by 850 ft) as illustrated on the above provided maps.

VI. Time of Completion

The contractor's performance and time of delivery are of utmost importance, and their endeavor toward the project shall be vigorous and continuous until completion. Work shall be completed and final delivery made to the Government within 20 calendar days from award date of contract.

VII. Inspection

The government may elect to perform independent field surveys in order to check and validate the accuracy and adequacy of the submitted data. The government reserves the right to reject inaccurate and substandard work. In the event such work is rejected, the contractor shall correct and replace rejected portions in a manner satisfactory and without cost to the government. The contractor shall coordinate his operations so as to permit direct contact with project manager purpose of inspection of work and general liaison.

VIII. Access to Work

The contractor shall be liable for and save the Government harmless on account of damages to persons or property in the performance of his work. The contractor must contact Ms. Jane Smyth at the base (918) 555-6000 at least one day in advance for instructions on entering the base.

IX. Commencement of Work

The contractor shall be prepared to begin the first full week after award of delivery order unless otherwise directed by the contracting officer.

X. Safety

General Safety Requirements. The Contractor shall comply with applicable safety regulations defined in the latest version of the U.S. Army Corps of Engineers Safety and Health Requirements Manual EM 385-1-1, and shall acquaint himself and his personnel with the safety requirements governing the area in which the work is being done. Total man-hours worked in the by survey and office personnel shall be provided to the project manager at the completion of the project.

XI. Project Manager

The project manager for this survey and mapping project will be Marjorie Ellenberg, Survey Section, 918-669-7574. All correspondence and information pertaining to the project will go through the project manager.

XII. Payment request shall be submitted to the A/E Contracts and Documents Section once each month. The request shall show a breakdown of all the related work tasks and percentage of work completed. Percent claimed will coincide with the progress report. The above should be mailed to:

*Tulsa District, Corps of Engineers
ATTN: A/E Contracts & Documents Section (CESWT-EC-DA)
1645 S. 101st E. Ave.
Tulsa, OK 74128-4629*

XIII. THE CONTRACTOR SHALL REFER TO APPLICABLE PORTIONS OF APPENDIX A FOR GENERAL AND TECHNICAL REQUIREMENTS NOT COVERED BY THIS SCOPE.

H-3. Government Cost Estimate

The following cost estimate was prepared by the Tulsa District. Field work was estimated at 3 days, with an additional 2 days to cover travel, security clearance, and site reconnaissance. In this IDC type contract, overhead is not included in the scheduled hourly rates and must be applied on each Task Order. Profit is computed separately for each Task Order as well. The final negotiated cost for this project was \$7,084.00 with a negotiated time being the same as the government estimate (5 days).

CONTRACT NO. DACW56-01-D-1005 TASK ORDER NO. 0035 MILITARY BASE FITNESS CENTER TOPOGRAPHIC SURVEY & MAPPING COST ESTIMATE			
1. ESTIMATED FIELD TIME			
PERSONNEL IN FIELD CREW			3 Crew
RECON AND ACCESS TO SITE			1 DAYS
ACCOMPLISH REQUIRED SURVEY			3 DAYS
TRAVEL			<u>1</u> DAYS
TOTAL DAYS			5
2. DIRECT LABOR COSTS:			
A) Project Supervisor			
10 Hrs x Rate	\$25.50		\$255.00
B). Registered Land Surveyor			
48 Hrs x Rate	\$23.50		\$1,128.00
C) Instrumentman			
40 Hrs x Rate	\$15.50		\$620.00
D). Rodman/Chainman			
40 Hrs x Rate	\$9.50		\$380.00
E) Cadd Operator			
60 Hrs. X Rate	\$14.00		<u>\$840.00</u>
Total Direct Labor Costs			\$3,223.00
3. OVERHEAD (Direct + G&A)			
115.00% Direct Labor	\$3,223.00		\$3,706.45
4. PROFIT (Direct Labor + Overhead)			
13.50% of L + O.H.	\$6,929.45		\$935.48
5. INDIRECT COSTS			
A). Survey Vehicle			
5 Days x Rate	\$120.00		\$600.00
B). Per Diem			
5 Days x Rate x 3	\$85.00		\$1,275.00
Total In-Direct Cost-----			\$1,875.00
6. TOTAL COST ESTIMATE-----			\$9,739.93

H-4. Survey Procedure

The survey was performed using a Sokkia total station and data collector. Project control was previously established based on NGS control using static DGPS methods.

The following list is a selected portion of the coordinate file from the data collector used on this project. Overall, some 1494 planimetric and topographic points were shot on this project, most of which were ground elevations.

1,2255473.732,599682.977,306.359,ME09	56,2255626.611,599247.060,312.160,COR F3 PED	108,2255666.685,599250.242,312.239,WATER
2,2256469.163,599404.039,311.006,TIE HE-8 BC	57,2255621.554,599236.271,312.409,tre .28 CEDAR	109,2255666.511,599262.140,311.843,WATER
3,2255647.821,599235.695,312.645,FC 3	58,2255609.051,599235.440,312.311,tre .330 CEDAR	110,2255666.284,599276.477,311.564,WATER
4,2255829.328,599264.325,312.088,fc4	59,2255589.216,599255.636,311.676,BUSH	111,2255666.345,599287.181,311.006,WATER
5,2255639.532,599222.247,312.600,G	60,2255590.873,599267.481,311.154,BUSH	112,2255664.983,599287.165,311.032,WV
6,2255754.242,599223.161,312.880,G	61,2255561.930,599288.365,310.249,BLDG COR	113,2255664.450,599287.258,310.961,FIRE H
7,2255664.325,599234.949,312.460,BC	62,2255574.764,599301.457,310.361,BLDG COR	517
8,2255585.068,599359.974,309.180,BC	63,2255563.828,599290.381,311.201,FINISH FLOOR	114,2255666.374,599300.851,310.649,WATER
9,2255827.003,599232.812,312.580,BC	64,2255589.068,599296.552,310.521,tre .170 TREE	115,2255666.305,599313.593,310.347,WATER
10,2255676.776,599287.202,311.089,RESECT	65,2255591.892,599303.640,310.358,BUSH	116,2255666.277,599328.936,310.141,WATER
11,2255659.105,599233.373,312.672,SWBT	66,2255583.999,599306.280,310.337,SPRINKLER PED	117,2255666.097,599344.488,309.931,WATER
12,2255650.759,599233.164,312.756,SWBT	67,2255588.649,599312.394,310.265,tre .230 TREE	118,2255665.640,599359.518,309.674,WV
13,2255639.535,599233.393,312.673,SWBT	68,2255591.176,599321.912,309.987,BUSH	119,2255665.810,599357.218,309.713,WATER
14,2255628.794,599233.059,312.612,SWBT	69,2255575.038,599356.829,309.459,PP 3P LIGHT	120,2255666.915,599359.977,309.733,STORM
15,2255616.364,599232.964,312.533,SWBT	70,2255575.488,599355.958,309.583,GV	SEWER
16,2255599.333,599232.936,312.330,SWBT	71,2255575.419,599357.212,309.488,SWBT	121,2255673.764,599357.429,309.773,WATER
17,2255588.379,599232.897,312.043,SWBT	72,2255575.677,599360.623,309.121,SWBT	122,2255673.630,599359.712,309.747,WV
18,2255580.434,599232.785,311.920,SWBT	73,2255568.731,599357.876,309.268,FIREH 406	123,2255702.587,599357.337,309.919,WATER
19,2255568.234,599233.240,311.940,SWBT	74,2255568.734,599357.118,309.397,WV	124,2255718.758,599357.570,309.830,WATER
20,2255575.028,599233.311,311.991,PP 3PHASE	75,2255573.935,599353.977,309.542,MH	125,2255736.751,599357.770,310.071,WATER
ELEC	76,2255583.201,599354.622,309.638,STOP	126,2255736.552,599359.831,309.966,FIRE H
21,2255593.252,599232.578,312.275,FP	DONTENTER	518
22,2255598.197,599232.561,312.365,FP	77,2255606.193,599352.683,309.595,tre 0.300 CEADR	127,2255743.577,599356.327,310.113,N GAS
23,2255603.224,599232.643,312.399,FP	78,2255610.147,599330.633,309.988,BIRD HOUSE	128,2255729.263,599356.112,309.999,N GAS
24,2255608.187,599232.668,312.445,FP	79,2255612.516,599355.449,309.604,CONTROL V	129,2255716.623,599356.008,309.773,N GAS
25,2255613.155,599232.710,312.536,FP	80,2255613.044,599355.476,309.629,CONTROL V	130,2255701.251,599355.721,309.753,N GAS
26,2255618.305,599232.587,312.593,FP	81,2255613.390,599353.326,309.642,SPRINKLER	131,2255679.544,599355.704,309.762,N GAS
27,2255620.419,599233.906,312.518,PP OUT LIGHT	VALVE	132,2255670.608,599356.430,309.753,N GAS
28,2255620.769,599234.074,312.533,TPED	82,2255612.206,599356.582,309.584,SPRINKLER	133,2255663.328,599356.751,309.707,N GAS
29,2255623.162,599232.804,312.664,FP	VALVE	134,2255664.437,599358.191,309.673,VALVE
30,2255628.055,599232.850,312.677,FP	83,2255614.421,599356.661,309.597,SPRINKLER	135,2255665.730,599358.208,309.669,UNKNO
31,2255633.122,599232.891,312.727,FP	VALVE	WN
32,2255638.277,599232.764,312.778,FP	84,2255623.540,599357.260,309.606,PP	136,2255664.505,599357.423,309.664,PP
33,2255643.022,599232.950,312.778,FP	85,2255646.968,599358.201,309.585,FIRE H 407	SWBT
34,2255648.263,599232.955,312.784,FP	86,2255646.967,599358.071,310.353,BM NE BOLT	137,2255665.757,599358.732,309.644,SWBT
35,2255625.153,599243.954,312.137,WALL PI	87,2255646.948,599357.568,309.636,WV	138,2255666.465,599362.435,309.577,SWBT
36,2255610.806,599247.884,311.918,WALL PI	88,2255649.609,599356.926,309.713,WV	139,2255710.761,599357.898,309.979,PP
37,2255605.751,599247.193,311.863,WALL PT	89,2255652.548,599357.468,309.698,STOP SIGN	140,2255755.029,599358.506,310.026,PP
38,2255604.090,599250.639,311.826,WALL POC	90,2255637.590,599285.525,311.011,tre .055 TREE	141,2255762.061,599358.752,310.066,BUS
39,2255603.938,599253.531,311.797,WALL END	91,2255636.564,599275.837,311.365,BUSH	STOP SIGN
40,2255602.374,599253.682,311.784,WALL PC	92,2255639.382,599267.552,311.602,BUSH	142,2255763.977,599356.738,310.120,N GAS
41,2255602.571,599255.058,311.832,WALL POC	93,2255633.178,599263.948,311.613,BUSH	143,2255763.987,599357.281,310.098,GV
42,2255603.019,599256.379,311.782,WALL PI	94,2255575.001,599236.366,311.883,SEWER MH	144,2255764.089,599359.673,310.084,N GAS
43,2255602.842,599256.494,311.779,WALL END	95,2255652.318,599219.782,313.106,SWBT	145,2255771.313,599356.792,310.290,N GAS
44,2255603.344,599257.620,311.769,WALL END	96,2255659.359,599219.791,313.149,SWBT	146,2255779.741,599356.801,310.291,N GAS
45,2255603.534,599257.548,311.787,WALL PI	97,2255665.806,599219.904,313.161,SWBT	147,2255779.990,599357.782,310.242,WATER
46,2255604.264,599258.772,311.793,WALL POC	98,2255672.264,599219.937,313.022,SWBT	148,2255766.789,599357.470,310.184,WATER
47,2255605.121,599259.842,311.803,WALL PC	99,2255665.624,599211.629,313.463,SWBT	149,2255766.572,599356.806,310.186,N GAS
48,2255606.309,599258.861,311.806,WALL END	100,2255666.414,599226.736,312.893,SWBT	150,2255759.238,599356.624,310.064,N GAS
49,2255608.488,599260.619,311.819,WALL POC	101,2255665.657,599234.146,312.761,TPED	151,2255759.310,599357.223,310.136,WATER
50,2255612.044,599261.917,311.773,WALL PT	102,2255666.501,599234.026,312.726,TPED	152,2255765.628,599358.795,310.063,SWBT
51,2255615.147,599257.495,311.874,WALL PI	103,2255667.284,599217.301,313.263,WV	BOX INGRD
52,2255627.600,599249.367,312.102,WALL END	104,2255667.275,599219.432,313.154,WV	153,2255765.647,599356.703,310.134,SWBT
53,2255626.229,599246.209,312.162,COR F3 PED	105,2255666.201,599218.786,313.135,TV CABLE	BOX INGRD
54,2255627.044,599245.836,312.184,COR F3 PED	106,2255668.374,599221.352,313.034,STORM SEWER	154,2255763.175,599356.609,310.130,SWBT
55,2255627.417,599246.683,312.178,COR F3 PED	107,2255666.878,599236.741,312.710,WATER	BOX INGRD

EM 1110-1-1005
1 Jan 07

155,2255763.036,599358.780,310.070,SWBT BOX INGRD
156,2255765.204,599355.522,310.228,MH
157,2255757.687,599351.546,310.208,tre .125 TREE
158,2255753.198,599345.046,310.132,BUSH
159,2255749.863,599336.031,310.295,tre .090 TREE
160,2255756.287,599326.170,310.510,tre .080 TREE
161,2255746.604,599324.402,310.453,tre .080 TREE
162,2255752.655,599319.838,310.563,COR CONC
163,2255751.377,599318.529,310.578,COR CONC
164,2255753.993,599318.521,310.582,COR CONC
165,2255751.849,599317.032,310.619,COR CONC SHELTER
166,2255752.065,599313.384,310.690,COR CONC SHELTER
167,2255748.434,599313.168,310.688,COR CONC SHELTER
168,2255748.188,599316.796,310.612,COR CONC SHELTER
169,2255759.082,599317.446,310.636,BUSH
170,2255759.134,599315.699,310.677,BUSH
171,2255759.613,599308.148,310.802,BUSH
172,2255759.631,599306.100,310.913,BUSH
173,2255749.133,599307.484,310.757,tre .080 TREE
174,2255767.551,599344.391,310.276,CEDAR CLUMP
175,2255767.779,599340.724,310.344,CEDAR CLUMP
176,2255767.978,599335.795,310.565,tre .400 TREE
177,2255767.429,599329.517,310.453,CEDAR CLUMP
178,2255767.326,599325.786,310.428,CEDAR CLUMP
179,2255767.576,599322.405,310.453,CEDAR CLUMP
180,2255767.781,599318.222,310.600,CEDAR CLUMP
181,2255767.949,599315.885,310.640,CEDAR CLUMP
182,2255771.501,599304.631,310.983,BUSH
183,2255769.399,599304.213,310.985,BUSH
184,2255767.229,599304.014,310.925,BUSH
208,2255802.652,599282.355,311.483,UDG ELEC
209,2255802.743,599270.826,311.647,UDG ELEC
210,2255802.853,599257.813,311.984,UDG ELEC
211,2255803.086,599243.161,312.539,UDG ELEC
212,2255802.689,599235.709,312.725,PP
213,2255784.818,599237.991,312.634,ELEC OUT PED
214,2255785.402,599238.828,312.604,UDG ELEC
215,2255794.014,599239.146,312.673,UDG ELEC
216,2255804.630,599239.530,312.566,UDG ELEC
217,2255809.687,599238.906,312.468,UDG ELEC
218,2255813.638,599237.426,312.422,ELEC PED
219,2255809.703,599243.624,312.454,UDG ELEC

220,2255821.031,599258.363,312.158,UDG ELEC
221,2255828.349,599268.536,311.990,LP
222,2255828.254,599295.706,311.406,SIGN PARK RULES
223,2255827.920,599299.564,311.326,LP
224,2255827.790,599292.231,311.426,UDG ELEC
225,2255827.687,599278.301,311.799,UDG ELEC
226,2255796.869,599254.310,312.094,tre .140 TREE
227,2255789.881,599263.102,311.934,tre .140 TREE
228,2255770.802,599250.649,312.229,tre .400 CEDAR
229,2255766.193,599238.234,312.698,MH
230,2255737.117,599241.022,312.566,BUSH
231,2255724.141,599252.029,312.177,tre .050 TREE
232,2255700.388,599253.391,312.128,tre .050 TREE
233,2255694.147,599260.610,311.813,tre CEDAR CLUMP
234,2255695.956,599274.640,311.369,tre .030 TREE
235,2255672.833,599239.978,312.676,COMM MH
236,2255664.273,599243.072,312.209,N GAS
237,2255665.921,599243.041,312.339,N GAS V
238,2255664.799,599240.799,309.830,LP
239,2255671.140,599346.607,310.057,ELEC MH
240,2255673.331,599343.978,310.050,COMM MH
241,2255665.053,599293.296,310.912,LP
242,2255665.268,599251.074,312.212,LP
243,2255674.481,599236.577,312.836,tre .500 TREE
244,2255674.600,599243.202,312.650,N GAS
245,2255688.339,599242.997,312.601,N GAS
246,2255705.659,599242.727,312.584,N GAS
247,2255705.649,599241.613,312.521,N GAS V
248,2255705.035,599233.485,313.127,N GAS
249,2255720.751,599242.638,312.516,N GAS
250,2255734.202,599239.541,312.703,N GAS
251,2255747.133,599236.730,312.736,N GAS
252,2255763.408,599236.281,312.768,N GAS
253,2255781.509,599235.956,312.806,N GAS
254,2255796.810,599236.171,312.767,N GAS
255,2255807.927,599238.364,312.596,N GAS
256,2255814.935,599239.156,312.564,N GAS
257,2255829.493,599235.170,312.559,N GAS
258,2255827.891,599234.151,312.648,STORM SEWER MH
259,2255844.362,599236.316,312.242,SWBT PED
260,2255841.994,599236.148,312.490,STOP SIGN
261,2255841.661,599235.572,312.489,PP LIGHT
262,2255831.445,599236.347,312.538,SWBT
263,2255825.014,599234.696,312.694,SWBT
264,2255825.858,599222.101,312.676,FIRE H 515
265,2255825.821,599220.058,312.796,WV
266,2255813.403,599236.719,312.694,CEDAR CLUMP
267,2255810.080,599236.622,312.664,CEDAR CLUMP
268,2255810.152,599234.643,312.777,SWBT
269,2255801.684,599234.567,312.819,SWBT
270,2255801.689,599235.367,312.791,TPED

271,2255796.119,599234.773,312.906,SIGN PARK RULES
272,2255789.522,599234.715,312.791,BUS ROUTE
273,2255784.773,599237.211,312.658,CEDAR CLUMP
274,2255770.968,599238.562,312.534,CEDAR CLUMP
275,2255769.220,599234.324,312.866,SWBT
276,2255763.389,599234.728,312.835,TPED
277,2255766.329,599218.173,312.776,SANITARY SEWERMH
278,2255756.152,599234.892,312.870,PP
279,2255802.743,599235.438,312.743,PP TRANSFORMER
280,2255754.956,599234.852,312.877,TPED
281,2255751.946,599233.802,312.973,SWBT
282,2255736.758,599233.458,313.005,SWBT
283,2255738.646,599221.194,312.989,FIRE H 514
284,2255738.457,599219.830,313.107,WV
285,2255729.595,599236.125,312.926,CEDAR CLUMP
286,2255722.408,599233.845,313.043,SWBT
287,2255710.647,599237.877,312.699,tre .500
288,2255711.569,599234.330,313.001,TPED
294,2255799.095,599290.876,311.346,COR
295,2255839.623,599357.835,310.190,G
296,2255799.188,599296.333,311.355,COR
297,2255798.211,599297.874,311.357,NE COR
298,2255798.580,599297.362,311.263,CTRLV
299,2255777.360,599298.171,311.353, PARK SIN
315,2255797.520,599352.992,310.346,CENTRAL PARK SIN
316,2255809.358,599357.912,310.230,WTR LINE
317,2255824.830,599358.189,310.314,WTR LINE
.847,599333.789,310.679,GUTR
402,2255830.674,599333.798,310.788,BC
403,2255828.862,599333.791,310.815,BSW
404,2255828.722,599346.654,310.609,BSW
405,2255830.586,599346.630,310.605,BC
406,2255830.752,599346.624,310.454,GUTR
407,2255766.299,599218.174,312.782,SANTM H
408,2255825.824,599221.971,313.419,TBM 515
409,2255766.169,599238.239,312.705,SANT MH
410,2255668.505,599369.572,309.460,G
411,2255700.525,599360.765,309.760,BC
412,2255729.476,599361.083,309.880,BC

H-5. Typical Planimetric Detail in Parking Area

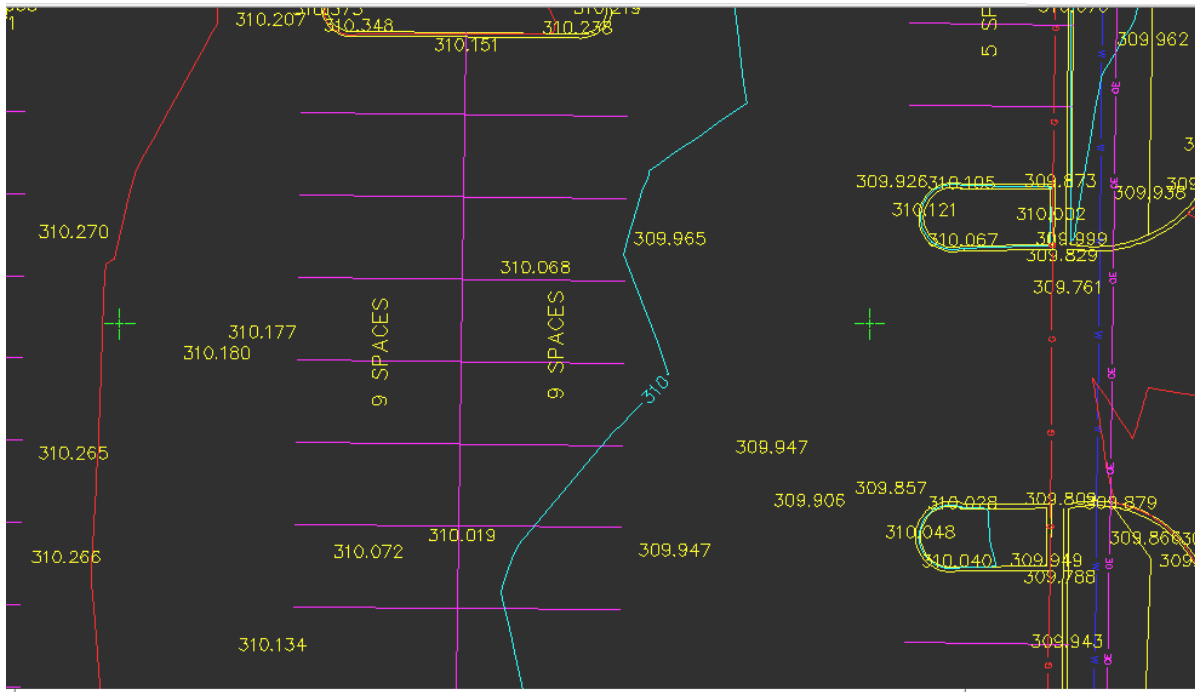

H-6. Typical Utility Details (Plan)

This section of the 10 acre site drawing depicts the varied utilities that were detailed in this area. In this area are shown underground cable, water, storm, and overhead electric utilities. Utility details were shown on two separate drawing sheets accompanying the three plan sheets. Detail # 235 on this plan is shown on the following plate.

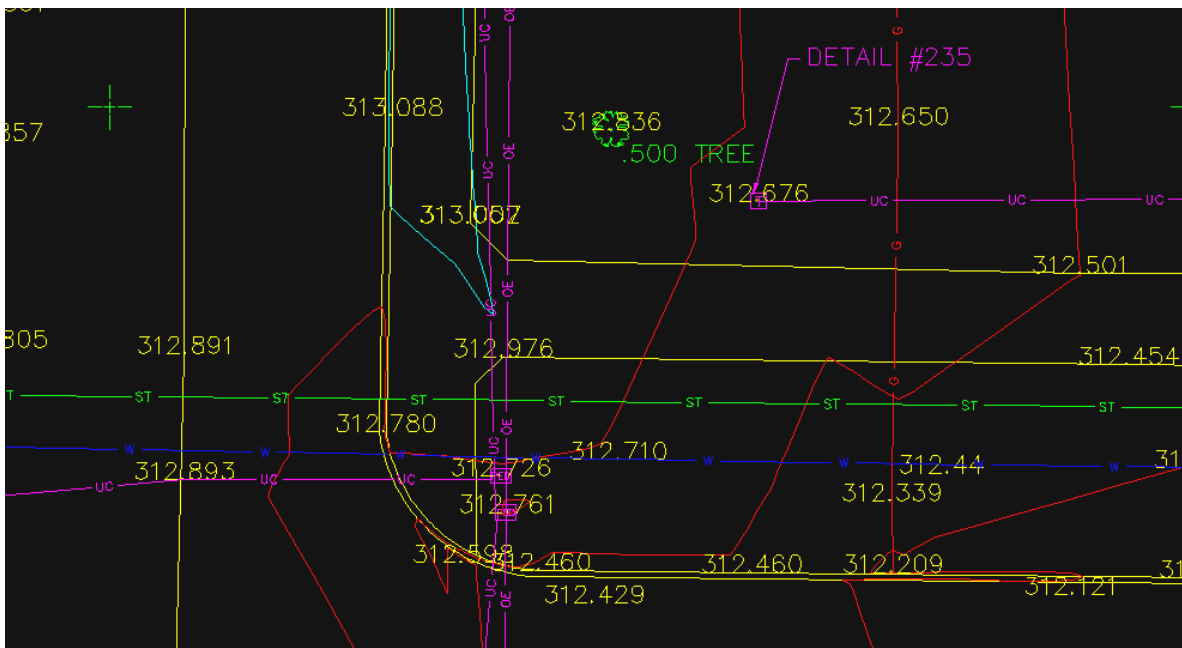

H-7. Utility Details (Plan and Elevation)

Typical utility details on the proposed site are shown below. The top plate is a precast communication box and the lower plate a sanitary sewer manhole.

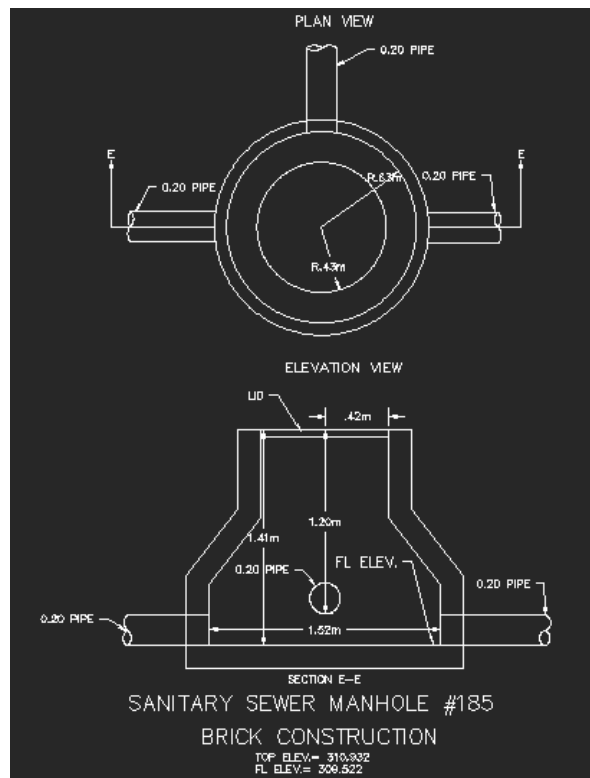
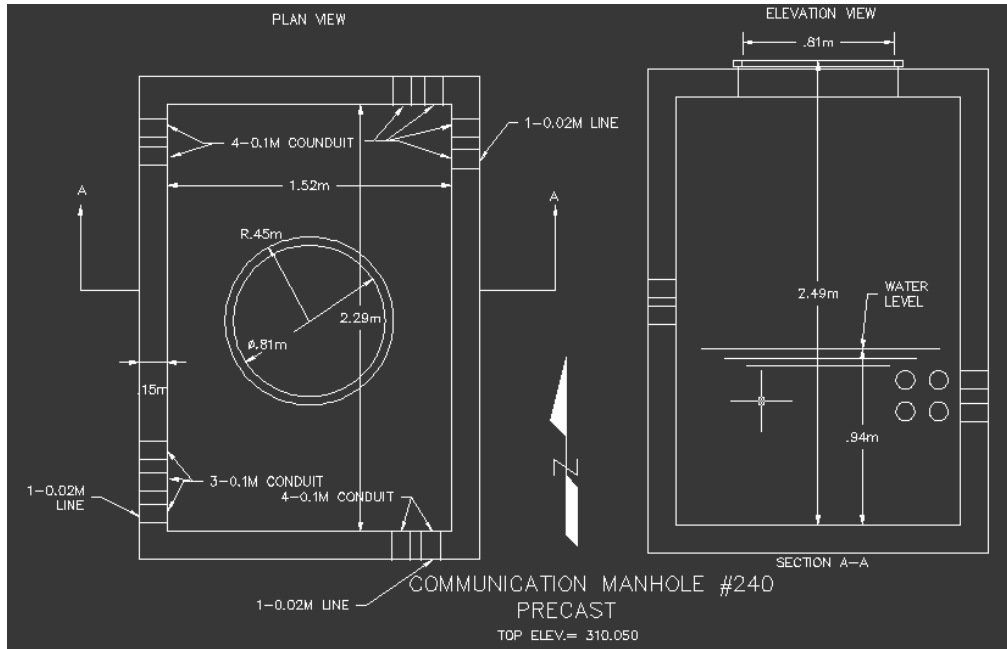

H-8. Triangulated Network

The following plate illustrated a triangulated network connecting elevation shots. Contours were created in AutoCAD from this network. The multiple triangles on the parking median curb are due to continuous elevation data points being generated around the circular curve.

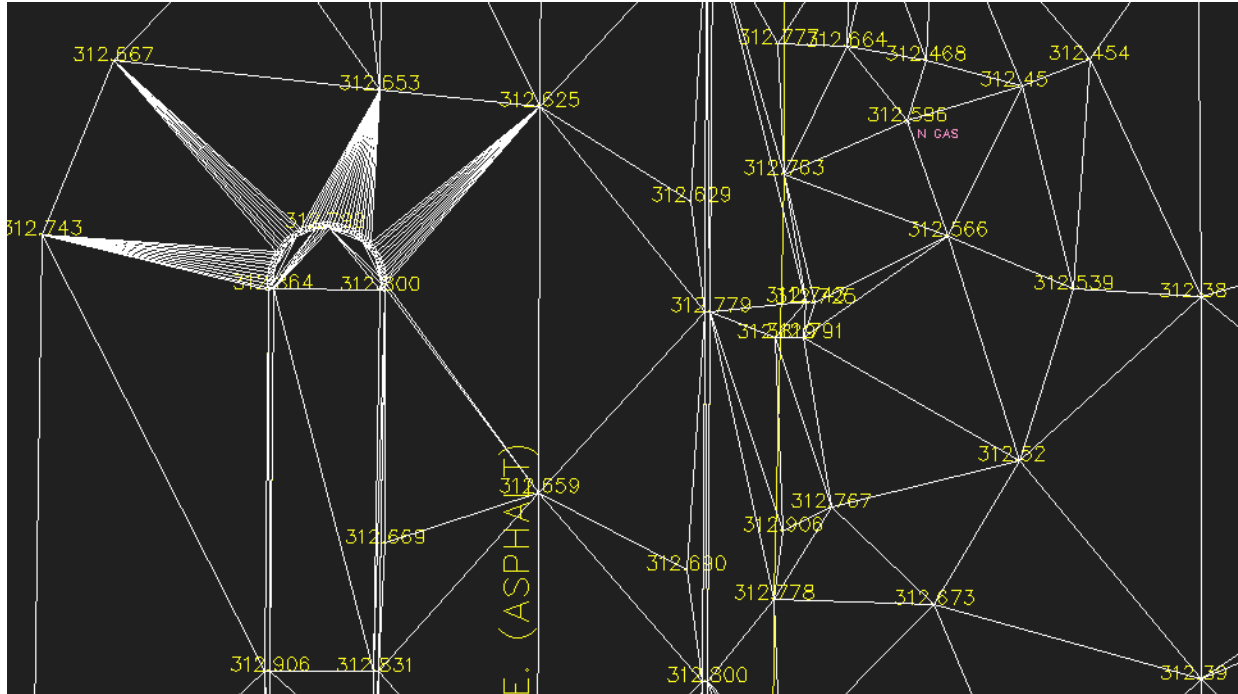

H-9. Control Description

The following control data sheet submitted in an AutoCAD dwg file contains a sketch of a control point set at the proposed site.

SURVEY CONTROL DATA						
Description of C. of E. Brass Cap			Adjusted Horizontal Control Data			
Station FC-3	State Oklahoma	Order: 2nd	Established by GPS			
County Tulsa	Chief of Party R. Entz		Combined Scale Factor:			
Year 2002	Described by R. Entz		NAD 27 Grid Data	Coordinates (US Survey Feet)	Plane Azimuth Angle	Azimuth Mark
Locality Military Base	Section	Township	State: OK	N		
	feet from	line &	Zone: North	E		
	feet from	line	Code: 3501			
Distances & Directions To Prominent & Reference Marks			NAD 83 Grid Data	Coordinates (Meters)	Plane Azimuth Angle	Azimuth Mark
Object	Distance (Feet)	Azimuth or Bearing	State: OK	N 145830.258		
			Zone: North	E 780450.293		
			Code: 3501			
			Metric Conversion Factor: 3.2808333333 ft/m			
Location Map			Geodetic Data	Position	Elevation NAVD 88	Elevation NGVD 29
			Latitude	N		
			Longitude	W		312.665m
			Field Sketch Of Monument (NTS) Station FC-3			
Prepared By: Entz Engineering & Assoc. and Huffman Surveying Company 600 Emporia St., Ste. "C" Muskogee, Oklahoma			Book:	4/16/2002		
			Page:			

SWT Form 598

Appendix I

Application: Control and Topographic Surveys Vicinity Footbridge at Willamette Mission Bottom, Oregon (Portland District)

I-1. Purpose and Background

This project involves a small topographic survey of a 0.5 acre site surrounding an existing 12 ft x 31 ft footbridge scheduled for replacement. The footbridge is located at Willamette Mission State Park. The park is adjacent to the Willamette River, Marion County Oregon. The target mapping scale was 1 inch = 40 ft at a 1 ft contour interval. The survey was performed in 2001 by in-house forces from Portland District. Details on the survey are described in the Survey Report in the next section.



I-2. Final Survey Report

Survey Report

Work Request No. 01-43

Job Name: Willamette Mission Surveys

Date of Survey: 16 – 18 April 2001

Performed By: CENWP-EC-HM personnel: Hoekstra, Bondurant, Howard

Geographic Information:

*Geographic Area: Willamette Mission Bottom AKA Wheatland Ferry
USGS 7-1/2 Quadrangle: Mission Bottom OR
Township Range Sections: T6S R3W WM
Projection Name: OR North
Horizontal Datum or Ellipsoid: NAD 83/91
Vertical Datum: NGVD 29/47
Projection Units: US Survey Feet*

Basis of Bearing/ Project Control: Data in this survey is based on the following monuments and the corresponding bearing and coordinate values.

<i>Point ID</i>	<i>Northing</i>	<i>Easting</i>	<i>Elevation</i>	<i>Description</i>	<i>PID #</i>
<hr/>					
<i>T5S R1W DLC 44 NW</i>	<i>536580.246</i>	<i>7591895.190</i>	<i>182.8</i>		<i>RD1626</i>
<hr/>					
<i>BM V 682</i>			<i>113.825</i>		<i>ORDOT</i>

Coordinate Precision: Third Order Class I

Description of Work: *The work involved setting control for mapping and construction purposes. Six points (3 point pairs) were set by GPS to enable data collection by total station. An additional point was set near the downstream footbridge near the Wheatland Ferry. The area surrounding the footbridge was mapped at a one-foot contour interval.*

Additional data was collected at two points upstream of the bridge. This data was supplied to requestors as coordinate data.

Equipment Used: *Equipment used are checked () below:*

*Ashtech Z-12 GPS receivers
Wild T2002 Total Station
DI5S Distance Meter
DI3000 Distance Meter
Gre-4 Data Collector
Wild NA2 Level*

Survey Software Used: Software used are checked () below:

Ashtech Inc. "Office" GPS adjustment Package
Listech Inc. "Liscad" survey software
Trimble Ltd "Geomatics Office" GPS adjustment Package

Survey Methodology: Control points were set in pairs at critical locations. The point pairs were located xyz using Rapid Static GPS. Each point pair was checked with a total station. Additional control points were set with the total station by multiple angle radiation (2 sets of angles). Topographic data was collected by single angle radiation. Sounding data was accomplished with a weighted tape hung from the side of the bridge at known locations.

Results of Survey: Accuracy is adequate for the requesters.

Survey Files:

Liscad Data files	
.See	Wmission.see
Archive Files	
Field data file (ASCII)	Mission.fld
ASCII DATA file	missbott.asc
Microstation Design file	Wmission.dgn
GPS Adj. Files	

Notes:

1. Digital archived located at: gis5\surveys\Projects\Willamette Mission
2. Hardcopy archived Willamette River cabinet.

Field-Surveyor's Comments:

1. Additional data was obtained from Otak Engineering Corp. with metric contours of the surrounding Wheatland Ferry Crossing.
 2. Hydrographic data in corresponding area does not match provided data by approx. 5 feet. Extensive checking of the data failed to reveal any problems. In addition Otak elevations fit well.
-

I-3. Data Collection

This 0.5 acre survey took one day to complete. One day was spent establishing control at the project site and at additional sites where data was needed. Control points were established by rapid static GPS observations. The actual site plan mapping took two days.

The Wild T2002 total station observations were collected using a Wild GRE-4A Data Collector. Approximately 395 points were shot during this project. A portion of the reformatted field data file (*.fld) from the total station is shown below. The field data file consists of a line number, a processor code, measurement data, and a descriptor code. Processor code 102 defines an occupation. Code 111 is a measurement block consisting of Horizontal Angle, Vertical Angle, Slope Distance and a Description code. Additional information concerning the field file format is available from Listech Corporations Leica Surveying Software.

1	010	WILD GRE-4A	Mission.raw	17	111	4306	89.58242	89.45262	1362.8400	00000
2	011	Monday,	April 23, 2001	18	161					
3	051	DM		19	;					
4	053	F		20	102	4305	5.4800	0.0000	4306	0.00000
5	021	YX		21	160	1	4	0		
6	;			22	111	4306	359.59596	89.45337	1362.8500	00000
7	102	4305	5.4800	23	105	5.5000				
8	160	1	4	24	111	4307	130.20287	90.02312	402.8900	00000
9	111	4306	359.59593	25	111	4307	310.22071	269.57205	0.0000	00000
10	105	5.3300		26	111	4306	180.01484	270.14523	0.0000	00000
11	111	11	129.19061	27	111	4306	269.59599	270.14514	0.0000	00000
12	111	11	309.20383	28	111	4307	40.20145	269.57336	0.0000	00000
13	111	4306	180.01409	29	111	4307	220.18441	90.02421	402.9000	00000
14	111	4306	269.59595	30	111	4306	89.58153	89.45384	1362.8400	00000
15	111	11	39.19012	31	;111	4306	359.59598	89.55427	311.7200	00000
16	111	11	219.17402	32	;111	4307	184.29579	89.54378	91.3900	00000
				33	;111	4307	4.31323	270.05406	0.0000	00000

The above reformatted file was created from the raw measurement by Leica LISCAD software. Data reduction, processing and terrain modeling was performed in Liscad. This data was then exported from LISCAD to MicroStation.

I-4. Site Plan Detail Plates

The following plate shows the detail captured around the footbridge. [The contours were generated from a TIN model created LISCAD].

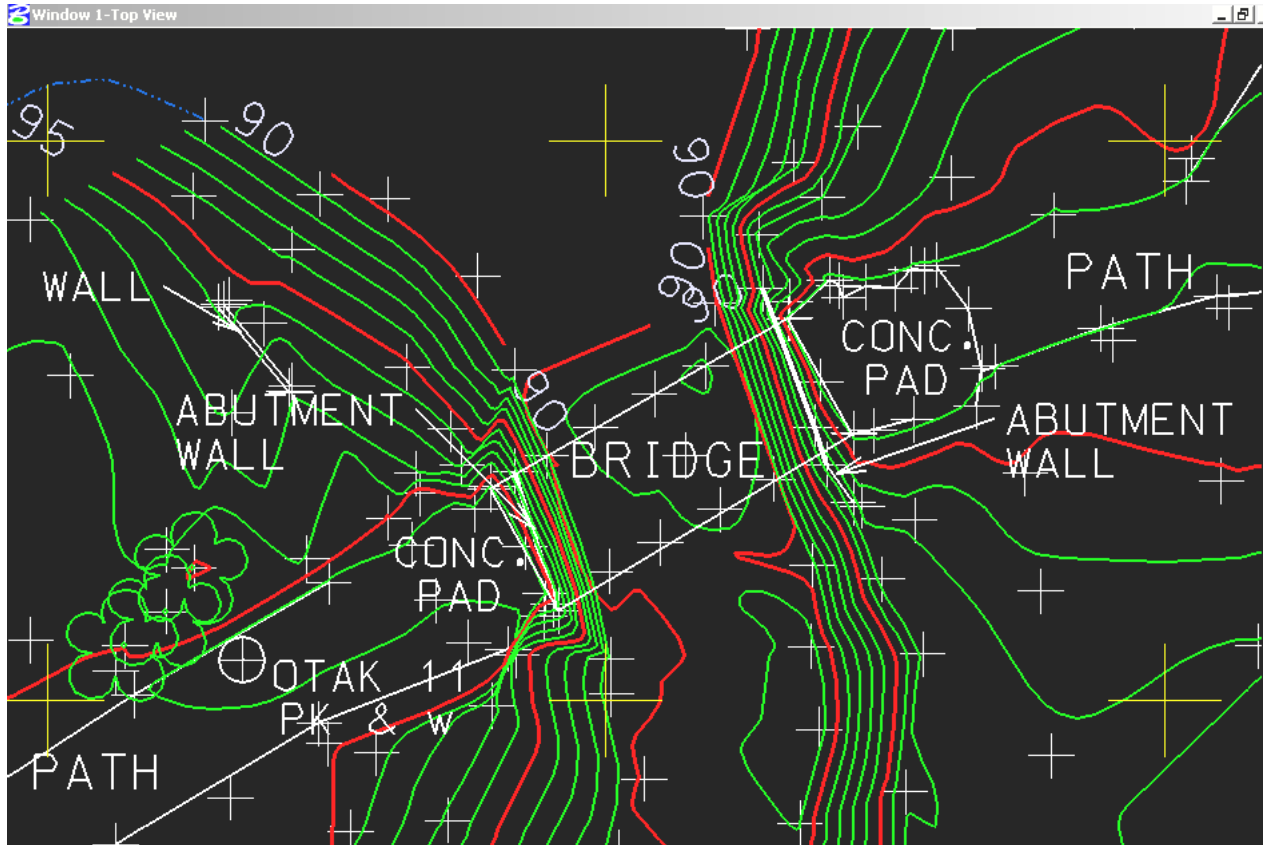

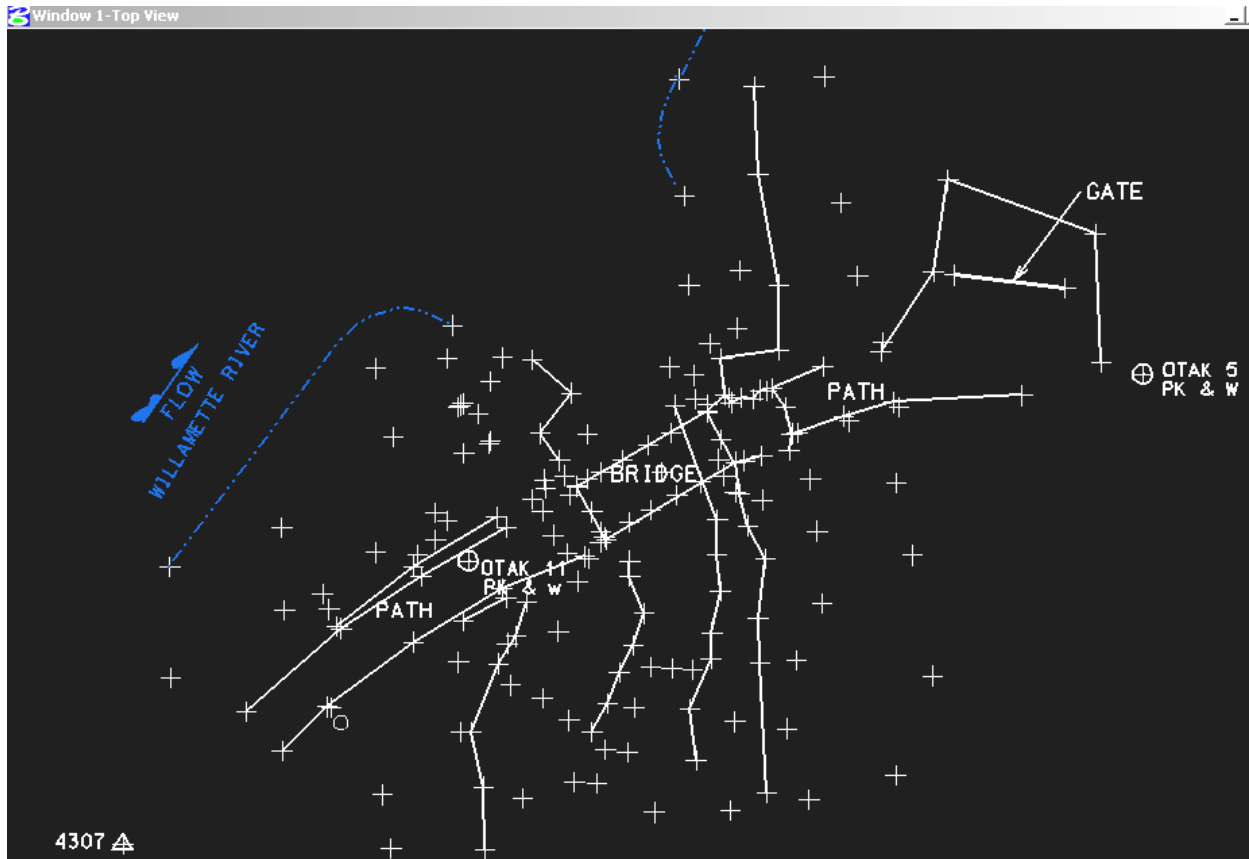

The above plate depicts the planimetric shots of the path and bridge. The ground elevation shots are indicated by a "+" sign and are spaced at roughly 10 to 15 ft intervals. The breaklines along the creek and at the top of riprap are shown by the connecting lines between ground shot points. Three control points for the total station survey are shown: "4307", "OTAK 11", and "OTAK 5".

Appendix J
Application: Topographic Survey for Proposed US Army Reserve Center
Belaire, Belmont County, Ohio (Louisville District)

J-1. Purpose and Background

The following plates are taken from a site plan survey performed in July 2003 by an in-house topographic survey crew from the Louisville District. The purpose of the survey was to provide the design team topographic and planimetric information for developing detailed plans for construction of the reserve center. The target scale was 1 inch = 50 ft with a 1 ft contour interval. NSRS control (NAD 83 & NAVD 88) was brought in by static GPS observations. Visible surface utilities were tied in--no underground utility connections were required. Planimetric features and ground shots were observed using a Trimble 5700 RTK unit and a Trimble 5600 total station. The following project summary report was drafted by the Louisville District Survey Section.

Final Report
Belmont County Memorial USARC
Bellaire, OH
July 2003

Survey Section was requested to perform a topo survey at the Belmont County Memorial Reserve site in Bellaire Ohio. This request came from Steve Thibaudeau.

The field survey was conducted during July 21-25, 2003. The data was processed during the week of August 4 and forwarded to Steve on August 12th on CD. Steve stated that the project has been put on the back burner.

A Reference Baseline was set (B1 and B2- iron pins). These points were positioned from NGS control points B316 and L115 using GPS static observations. Additional points were set from this baseline as needed.

Two boundary monuments were found at the southwest and northeast corners of the property. The deed description was plotted out and then rotated to match the found monuments.

A map showing the location of proposed drill holes was provided to William Puckett as requested.

Survey control datums: NAD 83 OH S SPCS / NAVD88

Field files are backed up on Data Disk #1462

DGN files are backed up on Map Disk # 4321

BLL, August 26, 2003

J-2. Planimetric Detail of Site

The following plate shows the general site planimetry.

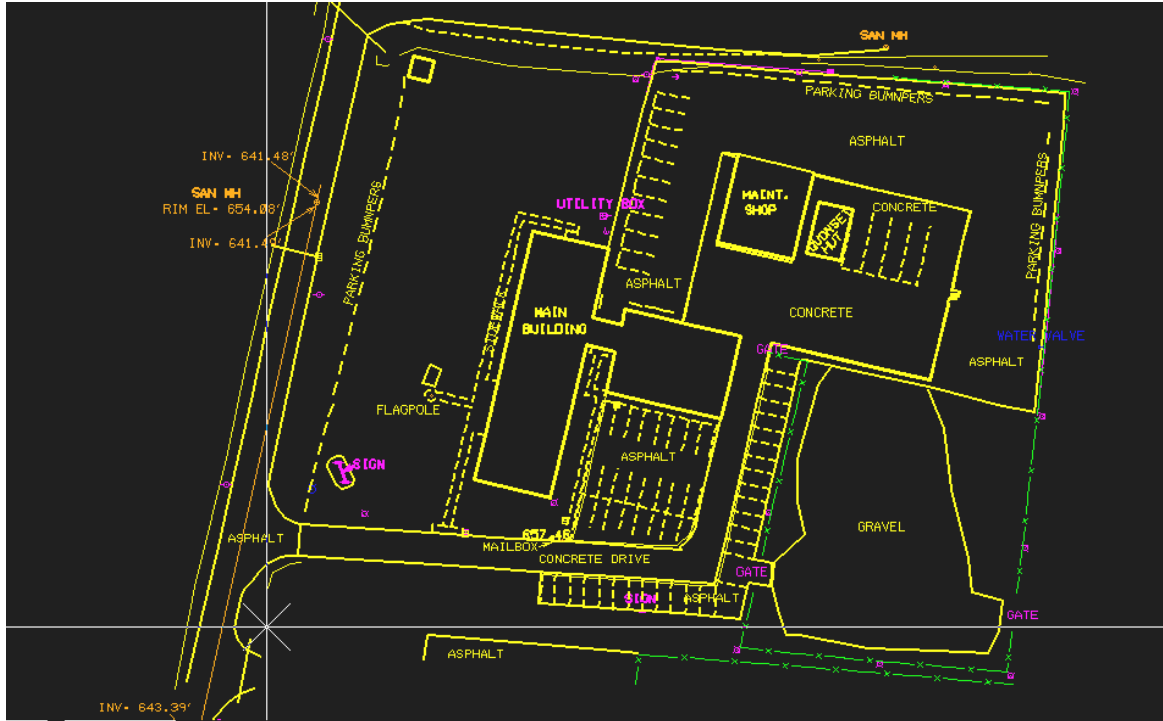

J-3. Boundary Ties and Primary Control Points

The following plates show the location and descriptions of two primary control points (B1-IPC and B2-IPC) set along the western perimeter of the site. Points B3-PK (near the Main Building) and B4-IPC (east of the Main Building) were tied in by static GPS observations to NSRS control outside the site. From these two points (B3-PK and B4-IPC) topographic mapping was performed by RTK methods--including ties to points B1 and B2. Two boundary control monuments were found and tied in, as shown below.

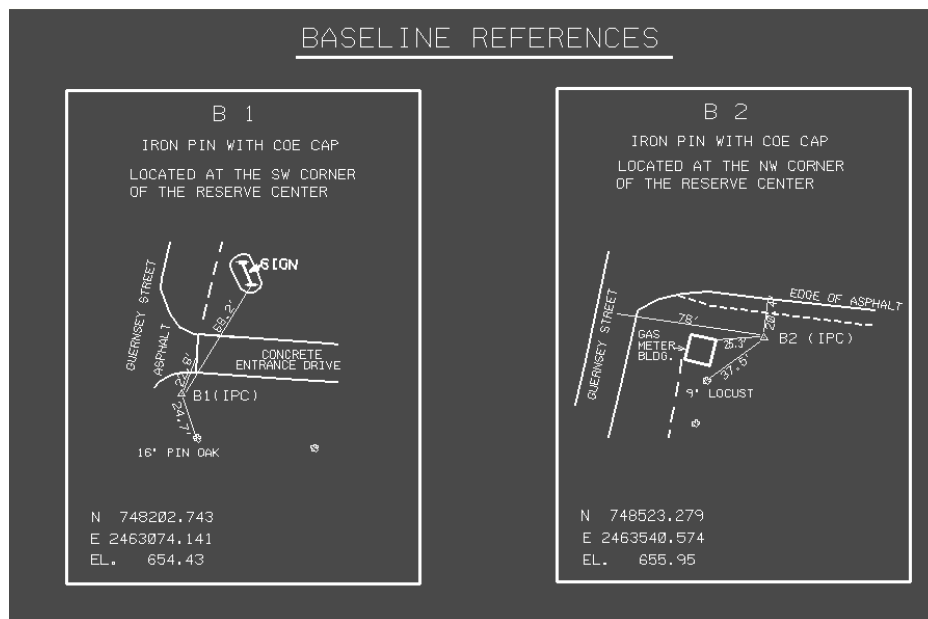

J-4. Control Ties to Local NSRS Network

The following plate shows 15-minute static GPS observations from fixed control points L-115 (23.3 K ft baseline) and B 316 (36.8 K ft baseline)--to points B3 and B4 on the site. The remaining site control monuments (B1, B2, SW MON, and B5) were tied in by RTK observations from B3. Final coordinates and elevations were determined by performing a least square adjustment of the GPS observations holding L-115 & B-316 fixed.

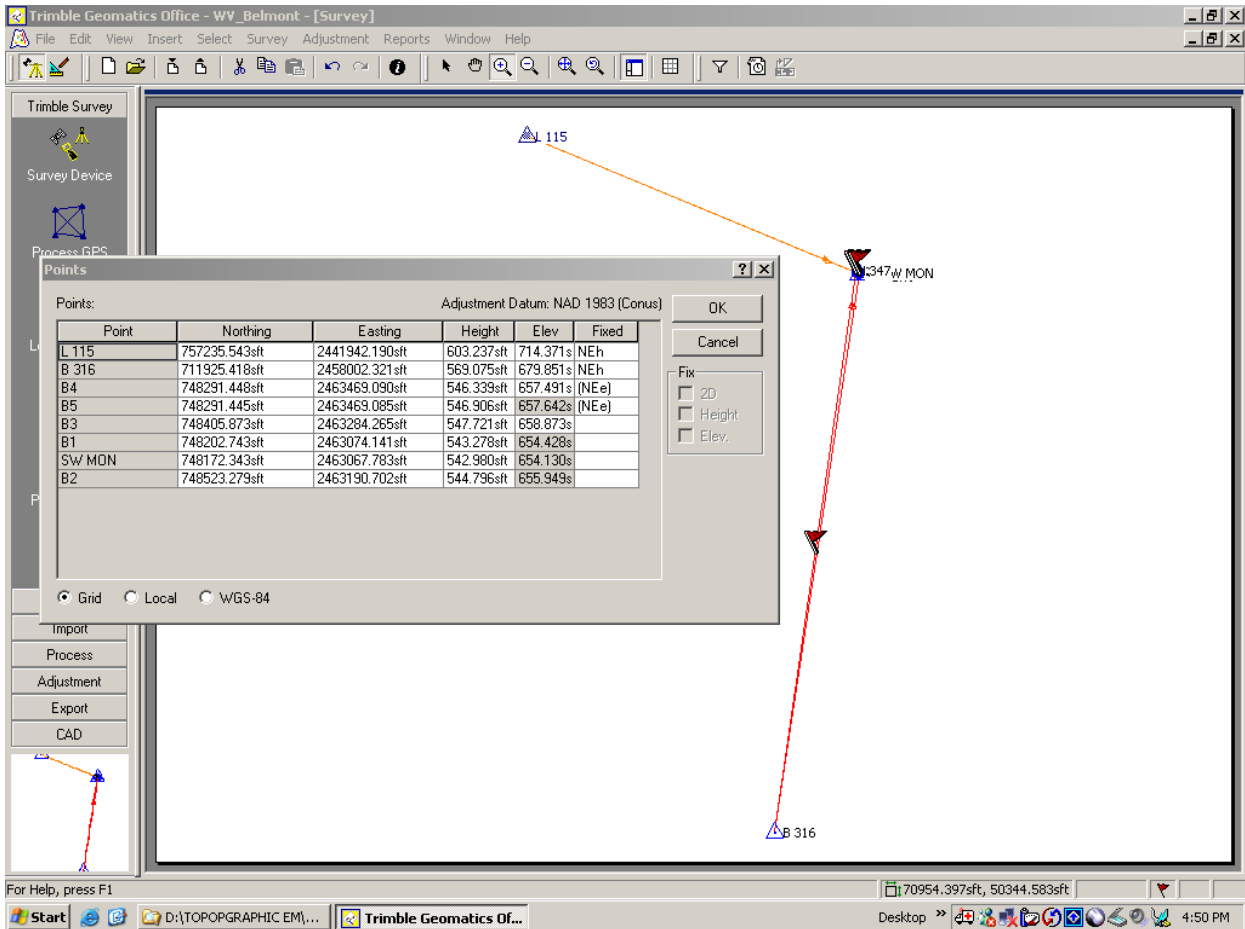

J-5. RTK Observations at the Site

The following plate shows RTK observations from points B3 and B4. Topographic points in the westerly portion of the site were obtained by total station.

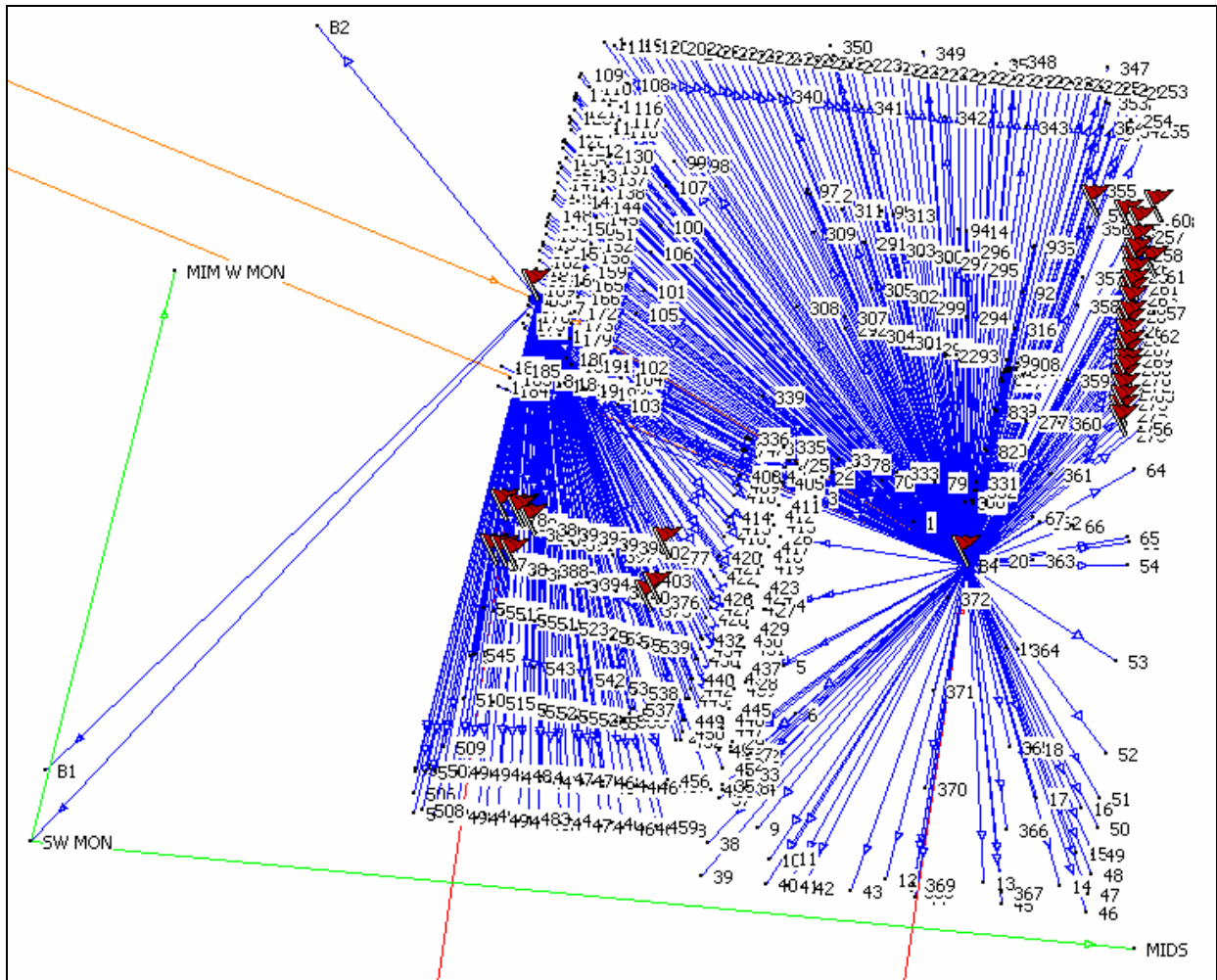

J-7. Planned Boring Locations and Surface Utilities

The following plate depicts the location of core borings (AD-1, AD-2, and AD-3).

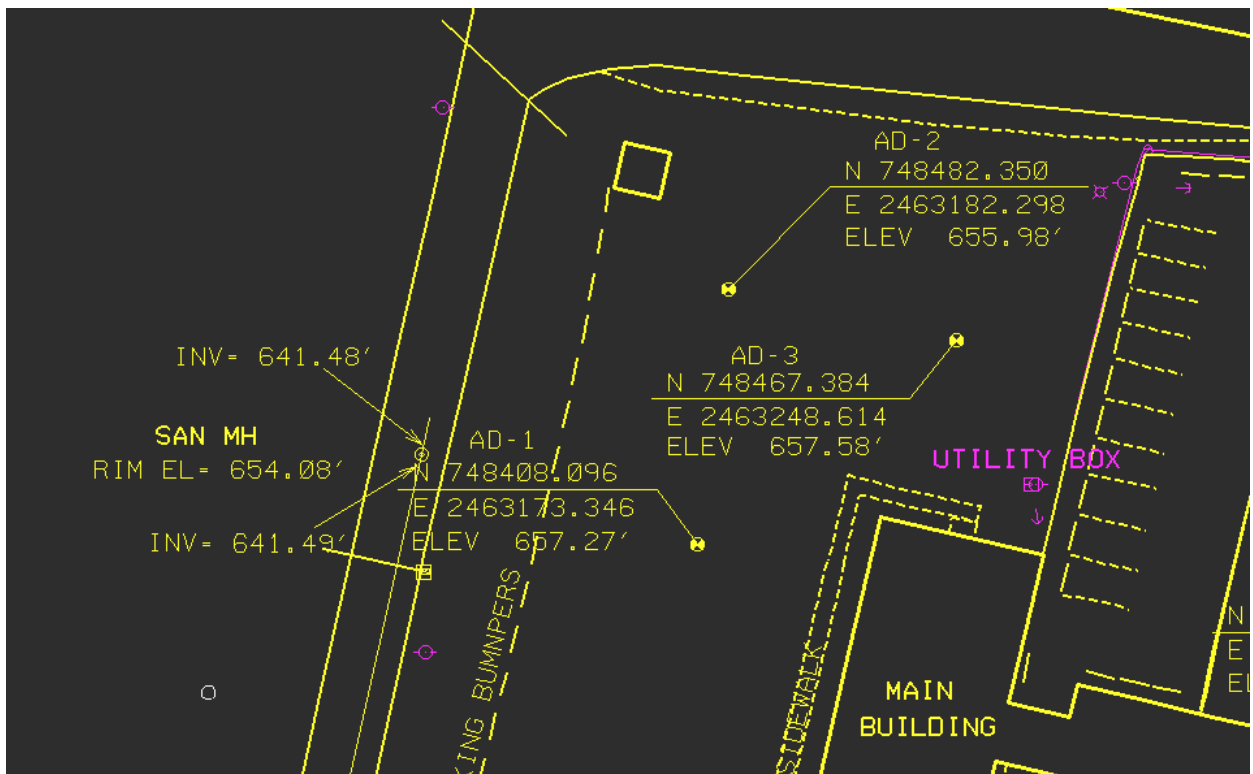

Appendix K
Application: Topographic and Boundary Surveys
Bayou Baton Rouge Drop Structure
Amite River and Tributaries, Comite River Diversion Project
East Baton Rouge Parish, Louisiana (New Orleans District)

K-1. Purpose and Background

The topographic and boundary surveys illustrated in this appendix were performed by New Orleans District in support of the Comite River Diversion Project. The surveys were conducted in 2004. Boundary surveys were performed on two tracts (201 and 317). These surveys were performed by task orders under an IDC AE contracts. CSI Chustz Surveying, Inc. of New Roads, LA performed the boundary surveys. NSRS reference control for the boundary surveys was established using the local CORS network. This appendix contains a sample metadata file for a boundary survey.

K-2. Scope of Work (Right-of Way Tracts)

Memorandum for ED-SS

Subject: Job No. 04-051 Request for Boundary Survey and Monumentation of Properties to be Acquired for the Comite River Diversion Project

1. Please survey the properties listed below and mark all corners using iron rods. Attached is a scope of work. Please contact all landowners prior to performing surveys.

<u>Tract No.</u>	<u>Owner Name</u>	<u>Contact</u>
201	***** , et ux	*****
317	***** , et ux	*****

2. Both tracts are located in Zachary Louisiana; tract 201 fronts Carney Road and Tract 317 fronts Old Baker Highway (Hwy 1209).

3. We have negotiated with both landowners for acquisition of these properties. The survey of the properties is one of the final steps to complete the acquisition process.

4. Should you encounter any problems with either landowner, please call our office immediately and ask to speak to *****.

5. Once the properties are surveyed, the contractor should revise plats and legal descriptions if necessary.

Comite River Diversion Project
Scope of Work for Survey Services

The work will consist of all services required to perform a complete property survey of tracts of land located within the right-of-way for the Comite River Diversion Project. The contractor shall perform all surveying services including furnishing of all personnel, transportation, equipment, and materials required in connection with this work. The services shall be provided under the professional supervision of a registered land surveyor, registered by the State of Louisiana. The survey is to be completed in

accordance with the technical provisions and special provisions contained herein as well as in conformance with the DOTD "Location and Survey Manual." Work will be ordered by individual purchase orders accompanied by right-of-way maps.

From recorded legal descriptions, the contractor shall survey and mark, with iron rods, the property lines and corners. The contractor will use the survey information to prepare individual parcel metes and bound descriptions with precise area calculations of ownerships as well as areas of acquisition. The survey shall also include the location and establishment of ownership of all utilities in the way of construction. The information should be provided both electronically as a CADD file and in reproducible form. The legal descriptions, plat maps, and the segment maps will continue to be prepared in the same manner as specified in the scope of work included in Job No. 02-062. However, as a new requirement the plat map will be stamped with the surveyor's seal and initialed by him.

K-3. Scope of Work (Topographic Surveys)

Memorandum for ED-SS

1. Request that surveys be performed for the subject project.
2. Enclosed for your use in the Survey Request form, Scope of Work, and copies of Right of Entry permits.
3. Please prepare an estimate of the time and costs associated with the work outlined in the attached Scope of Work, including the estimated start and completion dates for all work.
4. Prior to initiating any survey work at the site, contact Karen Borne (RE-F).
5. Prior to initiating any survey work at the site and preferably during the week of 25 May 2004, we would like to schedule a meeting to discuss the attached Scope of Work, to discuss the required coordination with Real Estate (including procedures for contacting property owners and dealing with hostile property owners), and to answer any questions you may have.
6. The ED-T point of contact for this work is Chris Dunn, x1799.

Survey Scope of Work--Comite River Diversion

1. The features of work for this project include:
 - Bayou Baton Rouge Drop Structure
 - Adjacent T-Walls
 - A Short Segment of the Channel
 - Bayou Baton Rouge Approach Channel
 - New Carney Road Bridge/Crossing of Bayou Baton Rouge
 - Guide Levees and Disposal Embankments
 - Bypass Aqueduct
2. Survey Work Required

The surveyors will follow standard surveying practices to accomplish the following tasks.

- *Locating enough PIs along the Project baseline, to re-establish the baseline in the vicinity of this project. (Estimate 3 PIs are required--see attachment).*
- *Establishing and staking the Comite River Diversion Channel centerline along the full length of the area as shown on the enclosed plan.*
- *Taking sufficient detailed topographic plane table surveys to readily prepare topographic maps of the proposed Comite River Diversion Channel, the proposed Bayou Baton Rouge Approach Channel, existing Bayou Baton Rouge, existing Carney Road in the vicinity of the structure, and all surrounding areas that may serve as locations for guide levees, disposal embankments, and/or drainage ditches.*
- *Cross-sections taken should extend along Bayou Baton Rouge from the southern right-of-entry limit to just north of the intersection of Bayou Baton Rouge and its tributary as shown in the enclosed plan. Cross-sections should be taken at 100-ft intervals; except north of the proposed structure, the cross-sections should be taken at 200 ft intervals as noted on the enclosed plan. These sections should extend from Bayou Baton Rouge to the adjacent right-of entry limits. Shots should be taken every 20 ft plus at all changes in grade. In the drop structure limits, every other section shall extend to the east right-of-way.*
- *Possible clearing of shrubbery and brush in heavily wooded areas, sufficient to allow completion of the work. The surveyors will minimize the cutting of small trees and the clearing of brush to obtain line-of-sight to take cross-sections and will not disturb any fences, pipelines, or other improvements within the area.*
- *Identification and location of existing structures and utilities, including the limits of all cemeteries, existing residences, bridges, etc.*
- *Perform topographic surveys and take cross-sections along the future realigned Carney Road Corridor.*
- *Cross-sections taken should extend along the future Carney Road Corridor at 150-ft width as shown on the enclosed plan. In the area of Hwy 964, cross-sections should be taken radially perpendicular to the Hwy and stop 25 ft before the private driveway as shown on the enclosed plan. Cross-sections should be taken at 50-ft intervals. Shots should be taken every 20 ft plus all changes in grade.*
- *Place hubs or approved similar marks (as shown on attached plans):*
 - *On both sides of Hwy 964 at the intersection of the diversion channel centerline.*
 - *Intersection of diversion channel centerline and drop structure centerline.*
 - *At the limits of the drop structure on the diversion channel centerline.*
 - *At the PI of the diversion channel centerline.*
 - *On both sides of existing Carney Road at the intersection of the diversion channel centerline.*
 - *4 hubs placed equidistant between the structure limits and Hwy 964.*
 - *3 hubs placed equidistant between the structure limits and Carney Road.*
- *Locate existing Carney Road azimuths and widths along Carney Road between 1,000 ft northwest and 500 ft southeast of the intersection with the diversion channel.*

3. *The attached maps illustrate all affected areas.*

4. *Borings shown on the attached maps will be taken by others.*

5 *Point of contact is Chris Dunn, x1799.*

K-4. GPS Control Survey Report (CSI Chustz Surveying, Inc.)

Two point pairs were set at each Tract--201A-201B and 317A-317B. These points were positioned by 2 hour static GPS observations from a single CORS site in New Orleans (ILSU). GPS baseline data were reduced using Trimble TGO software, and a network adjustment performed in TGO. The adjusted NAD 83 SPCS coordinates of point 317A was checked using an OPUS solution that utilized three CORS sites. The position difference was less than 0.04 ft.

**Comite River Diversion
GPS Control**

Project Summary

On June 24, 2004 Chustz Surveying, Inc. (CSI) received a Request for Proposal from the New Orleans District Corps of Engineers to perform Boundary Surveys for the Comite River Diversion Canal Project. The Survey Request required that boundary surveys be conducted on tracts 201 and 317. To facilitate this survey it was additionally requested that CSI perform a static GPS survey to establish horizontal control on the project. The control would be referenced to the Louisiana South State Plane Coordinate System.

With this project requiring horizontal control only, it was decided to establish one set of azimuth pairs with a minimum of two hours occupation time and then utilizing the CORS station ILSU located at Baton Rouge bring the horizontal into the project. Shorter one hour sessions would then be collected linking all four local controls. Two azimuth pairs were set at each tract and labeled; 201A, 210B, 317A and 317B. The two longer sessions were collected on 317A and 317B and the remaining sessions were collected in a leap frog fashion to close the figure to allow for loop closure checks. The data collected on 317A was uploaded to OPUS for a QC check.

The project work effort was estimated and negotiated with NOD resulting in a Delivery Order with Notice to Proceed issued on July 1, 2004. New Orleans District brass caps with rebar were set and described and the GPS data was collected.

EAST BATON ROUGE PARISH, LOUISIANA
SECTION 71 & 89, T 5 S - R 1 W, G.L.D.
0.764 ACRES

REFERENCES:
1) MAP SHOWING SURVEY AND RESUBDIVISION OF A 121.4 ACRE TRACT, FORMERLY THE MRS. CELESTIE CARNEY DEES PROPERTY, INTO TRACT A AND TRACT B, LOCATED IN SECTION 71, T-5-S, R-1-W, S.L.D., EAST BATON ROUGE PARISH, LOUISIANA FOR LEONCE C. BOURQUE, RECORDED AS ORIG. 671, BUNDLE 11194, CLERK OF COURT, EAST BATON ROUGE PARISH.

2) ACT OF DONATION FROM LEONCE CHARLES BOURQUE AND BETTY ELEAN BOURQUE TO MICHAEL PAUL HEDGES AND MICHELLE BOURQUE, HEDGES RECORDED AS ORIG. 382, BUNDLE 11261, CLERK OF COURT, EAST BATON ROUGE PARISH.

GENERAL NOTES:

HORIZONTAL DATUM: NAD-1983
PROJECTION: LAMBERT, LOUISIANA SOUTH ZONE
UNITS: U.S. SURVEY FEET
BEARINGS ARE BASED ON GPS MEASUREMENTS.

THIS SURVEY IS IN ACCORDANCE WITH THE APPLICABLE STANDARDS OF PRACTICE AS STIPULATED IN TITLE 46, CHAPTER 29 OF THE PROFESSIONAL AND OCCUPATIONAL STANDARDS, PART LXJ FOR PROFESSIONAL ENGINEERS AND LAND SURVEYORS FOR A CLASS "C" SURVEY.

AREA SUMMARY:

AREA NORTH OF HIGHWAY RIGHT-OF-WAY - 0.619 ACRES
AREA SOUTH OF HIGHWAY RIGHT-OF-WAY - 0.145 ACRES
TOTAL - 0.764 ACRES

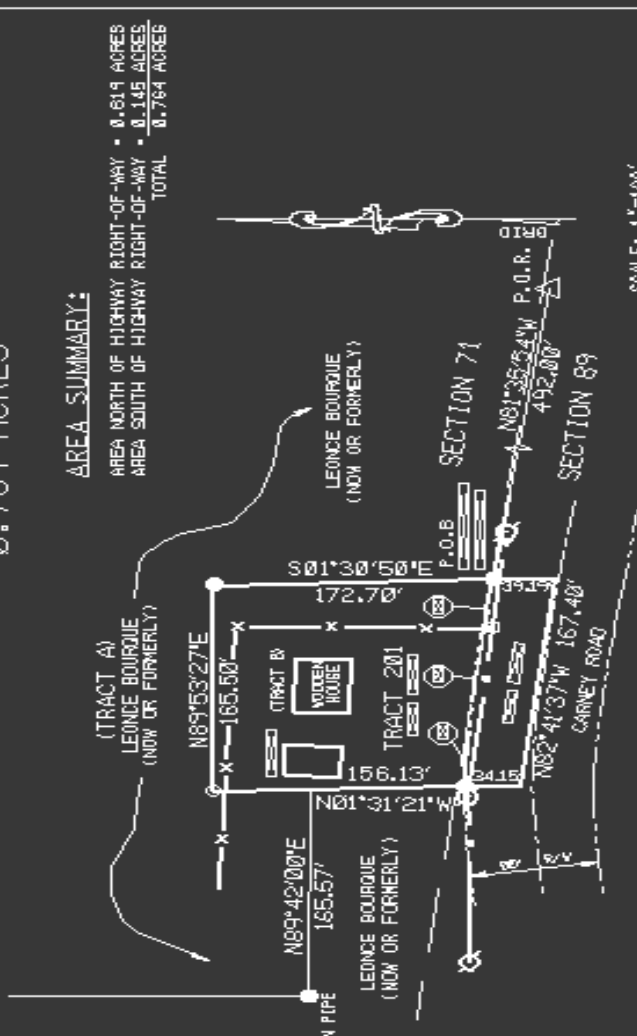

SCALE: 1"=100'

LEGEND:

- TRACT BOUNDARY
- FENCE
- OVERHEAD ELECTRIC LINE
- CENTERLINE OF CARNEY ROAD
- SECTION LINE
- TELEPHONE PEDESTAL
- WATER METER
- POWER POLE
- 1/2" IRON ROD SET
- 1/2" IRON PIPE FOUND OR AS SHOWN
- 4" X 4" CONCRETE LOH MONUMENT

CURVE TABLE

NUMBER	RADIUS	LENGTH	CHORD BEARING	CHORD LENGTH	DELTA
C-1	1417.24'	123.55'	N64°01'40"W	123.51'	04°53'42"
C-2	647.44'	19.28'	N89°13'35"W	19.28'	01°42'23"

LINE TABLE

NUMBER	DIRECTION	DISTANCE
L-1	N81°35'54"W	24.07'

CERTIFICATION:

I CERTIFY THAT IN JULY 2004 CHUSTZ SURVEYING, INC MADE A GROUND SURVEY OF THE AREA SHOWN HEREON AND THAT THIS PLAT IS IN ACCORDANCE WITH THE DATA OF SAID SURVEY.

JAMES H. CHUSTZ, P.E.
REGISTERED LAND SURVEYOR

Window Area

Print to Window: 1

BY CHUSTZ SURVEYING, INC. KEY ROAD, LOUISIANA

DEPARTMENT OF THE ARMY
U.S. ARMY ENGINEERS DISTRICT
NEW ORLEANS CORPS OF ENGINEERS
LOWER MISSISSIPPI VALLEY DIVISION

MICHAEL HEDGES, ET UX
TRACT NO. 201

DATE: 13 JULY 04 REV.

K-5. OPUS Solution Check (Point 317A)

The adjusted coordinates of Point 317A (N=774 648.581, E=3333 973.216) were compared with an independent OPUS solution that was based on 3 CORS base stations shown in the solution below. The OPUS solution (N=774 648.569, E=3333 973.178) checked within 0.04 ft of the GPS adjustment.

```

                                OPUS solution 317A1810.04o 000190296.txt
From: opus@ngs.noaa.gov
Sent: Friday, July 16, 2004 11:23 AM
To: lhines@chustz.com
Subject: OPUS solution : 317A1810.04o 000190296

FILE: 317A1810.04o 000190296

                                NGS OPUS SOLUTION REPORT
                                =====

USER: lhines@chustz.com                DATE: July 16, 2004
RINEX FILE: 317a181p.04o              TIME: 16:22:53 UTC

SOFTWARE: page5 0310.28 master3.p1     START: 2004/06/29 15:49:00
EPHEMERIS: igr12772.eph [rapid]        STOP: 2004/06/29 18:05:00
NAV FILE: brdc1810.04n                 OBS USED: 4792 / 5310 : 90%
ANT NAME: TRM41249.00                  # FIXED AMB: 34 / 38 : 89%
ARP HEIGHT: 2.0                        OVERALL RMS: 0.028(m)

REF FRAME: NAD83(CORS96) (EPOCH:2002.0000)    ITRF00 (EPOCH:2004.4937)
X: -111623.007(m) 0.035(m) -111623.651(m) 0.035(m)
Y: -5491868.290(m) 0.077(m) -5491866.807(m) 0.077(m)
Z: 3230661.001(m) 0.048(m) 3230660.820(m) 0.048(m)

LAT: 30 37 47.94788 0.010(m) 30 37 47.96714 0.010(m)
E LON: 268 50 8.21553 0.033(m) 268 50 8.19022 0.033(m)
W LON: 91 9 51.78447 0.033(m) 91 9 51.80978 0.033(m)
EL HGT: -3.352(m) 0.091(m) -4.709(m) 0.091(m)
ORTHO HGT: 23.909(m) 0.094(m) [Geoid03 NAVD88]

PLANE COORDINATES North(Y) East(X) Convergence (deg) Point Scale
UTM(Zone 15): 3390032.330(m) 675926.530(m) 0.93547156 0.99998181
SPC(1702 LA 5): 236113.356(m) 1016197.057(m) 0.08447652 0.99998586

US NATIONAL GRID DESIGNATOR: 15RXP7592790032(NAD 83)

                                BASE STATIONS USED
PID DESIGNATION LATITUDE LONGITUDE DISTANCE(m)
AJ7830 KJUN KJUN CORS ARP N301316.947 w0920242.388 95973.8
DF5754 ILSU LOUISIANA STATE U CORS ARP N302426.709 w0911048.915 24720.9
AJ7833 HAMM HAMMOND CORS ARP N303047.051 w0902803.428 68084.4

                                NEAREST NGS PUBLISHED CONTROL POINT
BJ0490 M 216 N303739. w0910938. 459.4

This position was computed without any knowledge by the National Geodetic Survey
regarding the equipment or field operating procedures used.
```

K-6. Tract 201 CSI "H-Record" Submittals to New Orleans District

The following submittal for Tract 201 corresponds to the New Orleans District criteria outlined in Chapter 12.

#H01 201_MISC.EM
#H02 JULY,13 2004
#H03 3
#H04 NAD83
#H05 04051
#H06 USFEET
#H07 1702
#H08 ZACHARY, LA.
#H09 CHUSTZ SURVEYING INC.
#H10 040031
#H11 1-16
#H12 1.0
#H20 COMITE RIVER DIVERSION PROJECT BOUNDARY SURVEYS (TRACT 201)
#H30 W912P8-04-D-0001
#H31 Task Order 0009
#H32 GPS POINTS 201A AND 201B WERE SET BY CHUSTZ SURVEYING, INC.
#H33 ON JUNE 29 2004. THERE POINTS WERE THEN USED AS CONTROL
#H34 POINTS FOR THE SURVEYS. REFER TO GPS SUMMARY UNDER FOLDER
#H35 ED-SS-P SURVEY CONTROL, FILE NAME GPSREPORT.PDF. THE GPS
#H36 POINTS ARE ALSO DESCRIBED IN BK. 040031 PGS. 1-6.

;
;
;-----VERTICAL CONTROL INFORMATION-----
;
; NONE
;
;

;
;-----TEMPORARY BENCK MARKS-----
;
; NONE
;
;

;
;-----FIELD PERSONNEL-----
;
#C01 MITCH LANGSTON
#C02 LONNIE DUPONT
#C03 KIM OUBRE
;

;
;-----EQUIPMENT-----
#E01 TOTAL STATION
#E02 LEICA T-1010
#E03 370556
;
#E01 LEVEL
#E02 TOPCON ATG3
#E03 5F6344
;
;

;
;-----WEATHER-----
;
; NOTE: WEATHER RECORDS ARE IN THE FIELD BOOKS
;
;

;
;
;
#B00 NONE

EM 1110-1-1005
1 Jan 07

;
#M01 MISCELLANEOUS SHOTS
;

7,772515.40,3322776.24,0.00,201A	1100,771672.58,3321842.99,0.00,BLD	1125,771537.60,3321665.61,0.00,CLR
8,771527.26,3322454.34,0.00,201B	1101,771673.30,3321818.77,0.00,BLD	1126,771523.43,3321620.86,0.00,CLR
9,771581.69,3321671.37,0.00,FP	1102,771708.69,3321820.19,0.00,BLD	1127,771514.49,3321593.65,0.00,CLR
1078,771518.15,3322450.80,0.00,FC	1103,771680.48,3321802.65,0.00,BLD	1128,771501.21,3321550.71,0.00,CLR
1079,771514.87,3322441.33,0.00,FC	1104,771680.19,3321796.09,0.00,BLD	1129,771489.52,3321502.36,0.00,CLR
1080,771550.34,3322176.59,0.00,FL	1105,771691.01,3321795.58,0.00,BLD	1130,771568.75,3321626.23,0.00,WM
1081,771566.80,3322061.93,0.00,FL	1106,771599.59,3321810.63,0.00,WM	1131,771557.43,3321634.40,0.00,RCP
1082,771584.73,3321937.87,0.00,FC	1107,771581.59,3321860.24,0.00,RCP	1132,771565.07,3321665.44,0.00,RCP
1083,771664.96,3321939.51,0.00,FL	1108,771578.14,3321892.14,0.00,RCP	1133,771509.95,3321732.99,0.00,HYD
1084,771738.60,3321939.58,0.00,FC	1109,771570.64,3322015.31,0.00,PPL	1134,771507.35,3321732.80,0.00,WV
1085,771742.40,3321857.21,0.00,FL	1110,771594.25,3321803.27,0.00,PPL	1135,771482.66,3321639.53,0.00,WM
1086,771744.81,3321797.15,0.00,FL	1111,771593.69,3321670.68,0.00,PPL	1136,771481.95,3321618.74,0.00,ROW
1087,771748.44,3321729.38,0.00,FC	1112,771533.51,3321527.79,0.00,PPL	1137,771510.27,3321887.59,0.00,ROW
1088,771752.10,3321972.90,0.00,IR	1113,771532.29,3321526.27,0.00,TEP	
1089,771579.46,3321977.46,0.00,IP	1114,771577.37,3321673.43,0.00,TEP	
1090,771563.99,3322069.83,0.00,PV	1115,771580.11,3321938.58,0.00,TEP	
1091,771565.54,3322057.66,0.00,PV	1116,771529.22,3322310.84,0.00,TEP	
1092,771666.52,3321913.89,0.00,CH	1117,771491.50,3322304.65,0.00,CLR	
1093,771700.84,3321914.41,0.00,CH	1118,771507.80,3322189.90,0.00,CLR	
1094,771702.20,3321871.26,0.00,CH	1119,771528.70,3322046.11,0.00,CLR	
1095,771573.49,3321643.46,0.00,IP	1120,771541.02,3321962.52,0.00,CLR	
1096,771693.09,3321643.49,0.00,IP	1121,771546.40,3321922.56,0.00,CLR	
1097,771692.22,3321809.06,0.00,IP	1122,771553.68,3321860.50,0.00,CLR	
1098,771595.71,3321811.55,0.00,IP	1123,771555.83,3321809.42,0.00,CLR	
1099,771592.24,3321801.61,0.00,IR	1124,771549.29,3321725.36,0.00,CLR	

K-7. Tract 201 Control Description

The following figure shows a field description and sketch made of a newly set mark at Tract 201--“201A WEST”.

Point #7
 C.O.E. No. = 04-051
 Comite River Diversion Project
 Boundary Surveys
 201A 04051

Point Description
 To reach station from the Municipal Buildings of Zachary La. (East Baton Rouge Parish) @ Florida St. and Main. Then we West on La Hwy #64 (Main St.) for 233 ft. To the Intersection of La Hwy #964 (Scenic Hwy) #64. Thence Left on South on La Hwy #964 (Scenic Hwy) for 2.2 miles, to the Station on the Right.

Point is a standard C.O.E. Cap: Rod (Iron) 2.5", set 0.5' below ground, stamped: 201A 04051 in the Year.

Point is 3' East of a Barbed Wire fence @ Cow Pasture, 10' N-N-E of a Fence corner, that divides Pastures, 4' North of a Water Meter, 8' North of a White orange (3" diam. PVC) Fiber optic Cable Marker, 12' N-N-W of the 6th Power Pole North of Corridor and 4'-87" West of E of La Hwy #964 (Scenic Hwy).

Section - NAD-83 (Hand Held)
 Township - Lat - N - 30° 37' 27.1"
 Range - Long - W - 91° 11' 59.9"

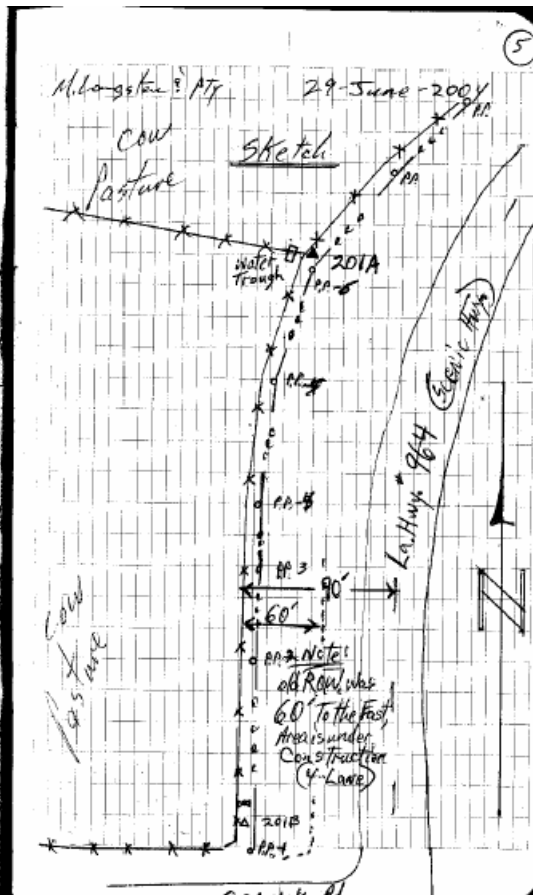

K-8. Description of Tract 201

**COMITE RIVER DIVERSION PROJECT
AMITE RIVER AND TRIBUTARIES
NEW ORLEANS CORPS OF ENGINEERS**

TRACT: 201
OWNER: MICHAEL HEDGES, et ux
ACRES: 0.764

A certain tract of land designated as TRACT 201, together with any and all buildings, improvements and appurtenances thereon, located in Sections 71 & 89, T 5 S – R 1 W, Greensburg Land District, East Baton Rouge Parish, Louisiana, and being a portion of a Right-of-Way to be acquired to accommodate construction of Comite River Diversion Project and being more particularly described as follows:

For a POINT OF REFERENCE (P.O.R.), commence at a Louisiana Department of Highway concrete monument found, located along the North Right-of-Way of Carney Road; thence proceed North 81 degrees 35 minutes 54" West a distance of 492.00 feet to a 1/2 inch iron pipe found, being the POINT OF BEGINNING (P.O.B.)

From said POINT OF BEGINNING, proceed South 01 degrees 30 minutes 50 seconds East a distance of 39.19 feet to a point; thence proceed North 82 degrees 41 minutes 37 seconds West a distance of 167.40 feet to a point; thence proceed North 01 degrees 31 minutes 21 seconds West a distance of 34.15 feet to a 1/2 inch iron pipe found; thence proceed North 01 degrees 31 minutes 21 seconds West a distance of 156.13 feet to a 1/2 inch iron rod set; thence proceed North 89 degrees 53 minutes 27 seconds East a distance of 165.50 feet to a 1/2 inch iron pipe found; thence proceed South 01 degrees 30 minutes 50 seconds East a distance of 172.70 feet to a 1/2 inch iron pipe found which is the POINT OF BEGINNING.

The herein tract of land described as TRACT 201 contains 0.764 acres including the Right-of-Way along Carney Road and is bounded on the North, East and West by Leonce Bourque, now or formerly, and on the South by the centerline of Carney Road.

It is the intention of this description to include all of the land acquired by MICHAEL PAUL HEDGES and MICHELLE BOURQUE HEDGES from LEONCE CHARLES BOURQUE and BETTY EGAN BOURQUE by an Act of Donation dated October 18, 2001 and recorded as Original 392 Bundle 11281 in the records of East Baton Rouge Parish, Louisiana.

K-9. Tract 201 Metadata File

Identification_Information:

Citation:

Citation_Information:

Originator: New Orleans District, U.S. Army Corps of Engineers

Publication_Date: JULY,13 2004

Title: COMITE RIVER DIVERSION PROJECT BOUNDARY SURVEYS

(TRACT 201)

Publication_Information

Publication_Place: New Orleans, LA

Publisher: New Orleans District, U.S. Army Corps of Engineers

Online_Linkage:

<NONE>

Online_Linkage:

<NONE>

Description:

Abstract:

Surveys are conducted in support of the Corps of Engineers Civil Works programs such as Flood Control, Navigation, and Hurricane Protection projects.

Purpose:

The purpose of the surveys are to provide a current site model, and to be used as an engineering and planning tool for future Flood Control, Navigation, and Hurricane Protection projects.

Time_Period_of_Content:

Time_Period_Information:

Single_Date/Time:

Calendar_Date: JULY,13 2004

Currentness_Reference: publication date

Status:

Progress: Complete

Maintenance_and_Update_Frequency: Daily.

Spatial_Domain:

Bounding_Coordinates:

West_Bounding_Coordinate: 3333888.22

East_Bounding_Coordinate: 3334309.85

North_Bounding_Coordinate: 774648.55

South_Bounding_Coordinate: 772539.88

Keywords:

Theme:

Theme_Keyword_Thesaurus: none

Theme_Keyword: Boundaries

Theme_Keyword: Hydrography

Theme_Keyword: Topography

Place:

Place_Keyword_Thesaurus: none

Place_Keyword: New Orleans

Place_Keyword: Louisiana

Place_Keyword: ZACHARY, LA.
Temporal:
Temporal_Keyword_Thesaurus: None
Temporal_Keyword: JULY,13 2004

Access_Constraints:
None.

Use_Constraints:
This survey information is accurate as of the date of publication. Topographic-Hydrographic survey data is subject to change rapidly due to several factors including but not limited to dredging activity and natural shoaling scouring processes. The U. S. Army Corps of Engineers accepts no responsibility for changes in the conditions which develop after the date of publication. This information is intended for the internal use of the U. S. Army Corps of Engineers and it is being provided for external use as a public service. This agency accepts no responsibility for errors or omissions contained in this data. The accuracy of this data is therefore not guaranteed, and prudent surveyors or mariners should not rely solely upon it.

Point_of_Contact:

Contact_Information:

Contact_Person_Primary:

Contact_Person: Mark W. Huber

Contact_Address:

Address_Type: mailing address

Address:

U.S. Army Corps of Engineers

New Orleans District

Survey Section

CEMVN-ED-SS

P.O. Box 60267

City: New Orleans

State_or_Province: LA

Postal_Code: 70160-0267

Country: USA

Contact_Voice_Telephone: (504) 862-1852

Contact_Facsimile_Telephone: (504) 862-1850

Contact_Electronic_Mail_Address: mark.w.huber@MVN02.usace.army.mil

Data_Quality_Information:

Logical_Consistency_Report:

The quality of data collected is consistent between dates and vessels collection information.

Completeness_Report:

The listed surveys represent complete collection for this date.

Positional_Accuracy:

Horizontal_Positional_Accuracy:

Horizontal_Positional_Accuracy_Report:

Hydrographic Survey Data collected via DGPS and

XY accuracy is +/- 3 feet.
Topographic Data is Third Order Class II

Lineage:

Source_Information

Source_Citation:

Citation_Information:

Originator: New Orleans District.

Publication_Date: Unpublished material

Title: No title, data not formally published,
hard copy is avail

Geospatial_Data_Presentation_Form: ASCII File

Publication_Information:

Publication_Place: n/a

Publisher: n/a

Other_Citation_Details: n/a

Type_of_Source_Media: paper

Source_Time_Period_of_Content:

Time_Period_Information:

Single_Date/Time:

Calendar_Date: JULY,13 2004

Source_Currentness_Reference: ground condition

Source_Citation_Abbreviation:

Not avail.

Source_Contribution:

Not avail.

Process_Step:

Process_Description:

Hydrosurveys are collected via DGPS. Topographic
surveys are typically collected with total stations.

Source_Used_Citation_Abbreviation: N/A

Source_Used_Citation_Abbreviation: N/A

Process_Date: JULY,13 2004

Source_Produced_Citation_Abbreviation:

N/A

Process_Contact:

Contact_Information:

Contact_Person_Primary:

Contact_Person: Ronald W. King

Contact_Address:

Address_Type: mailing address

Address:

U.S. Army Corps of Engineers

New Orleans District

Survey Section

CEMVN-ED-SS

P.O. Box 60267

City: New Orleans

State_or_Province: LA

Postal_Code: 70160-0267

Country: USA

Contact_Voice_Telephone: (504) 862-1853

EM 1110-1-1005
1 Jan 06

Contact_Facsimile_Telephone: (504) 862-1850
Contact_Electronic_Mail_Address:

ronald.w.king@MVN02.usace.army.mil

Spatial_Data_Organization_Information:

Indirect_Spatial_Reference:

Filename: 317_MISC.em

This survey data is presented in an ASCII XYZ coordinate file.

Direct_Spatial_Reference_Method: Vector

Spatial_Reference_Information:

Horizontal_Coordinate_System_Definition:

State Plane:

Zone: 1702

Unit_of_Measure: USFEET

Entity_and_Attribute_Information:

Overview_Description:

Entity_and_Attribute_Overview:

The data attributes consist of soundings, depth curves (soundings), and obstructions.

Entity_and_Attribute_Detail_Citation:

not req'd.

Distribution_Information:

Distributor:

Contact_Information:

Contact_Person_Primary:

Contact_Person: Ronald W. King

Contact_Address:

Address_Type: mailing address

Address:

U.S. Army Corps of Engineers

New Orleans District

Survey Section

CEMVN-ED-SS

P.O. Box 60267

City: New Orleans

State_or_Province: LA

Postal_Code: 70160-0267

Country: USA

Contact_Voice_Telephone: (504) 862-1853

Contact_Facsimile_Telephone: (504) 862-1850

Contact_Electronic_Mail_Address: ronald.w.king@MVN02.usace.army.mil

Resource_Description: not applicable

Distribution_Liability:

The Government furnishes this data and the recipient accepts and uses it with the express understanding that the United States Government makes no warranties, expressed, or implied, concerning the accuracy,

completeness, reliability, usability, or suitability for any particular purpose of the information and data furnished. The United States shall be under no liability whatsoever to any person by reason of any use made thereof. This data belongs to the Government. Therefore, the recipient further agrees not to represent this data to anyone as other than Government provided data. The recipient may not transfer this data to others without also transferring this disclaimer.

Standard_Order_Process:

Digital_Form:

Digital_Transfer_Information:

Format_Name: EM

Format_Information_Content: ASCII XYZ Format

Transfer_Size: 0.500 megabytes

Digital_Transfer_Option:

Online_Option:

Computer_Contact_Information:

Network_Address:

Network_Resource_Name:

<NONE>

Online_Computer_and_Operating_System:

Windows NT Server running Netscape WWW Server

Offline_Option:

Offline_Media: 3.5 inch diskette

Recording_Format: DOS for diskette

Fees: Labor and media fees will be charged for requests for off-line data

Metadata_Reference_Information:

Metadata_Date: JULY,13 2004

Metadata_Contact:

Contact_Information:

Contact_Person_Primary:

Contact_Person: Mark W. Huber

Contact_Address:

Address_Type: mailing address

Address:

U.S. Army Corps of Engineers

New Orleans District

Survey Section

CEMVN-ED-SS

P.O. Box 60267

City: New Orleans

State_or_Province: LA

Postal_Code: 70160-0267

Country: USA

Contact_Voice_Telephone: (504) 862-1852

Contact_Facsimile_Telephone: (504) 862-1850

Contact_Electronic_Mail_Address: mark.w.huber@MVN02.usace.army.mil

Metadata_Standard_Name:

FGDC Content Standards for Digital Geospatial Metadata

Metadata_Standard_Version: 19940608

K-10. Topographic Surveys Performed by New Orleans District In House Personnel

The following plate depicts a portion of the topographic surveys performed on this project.

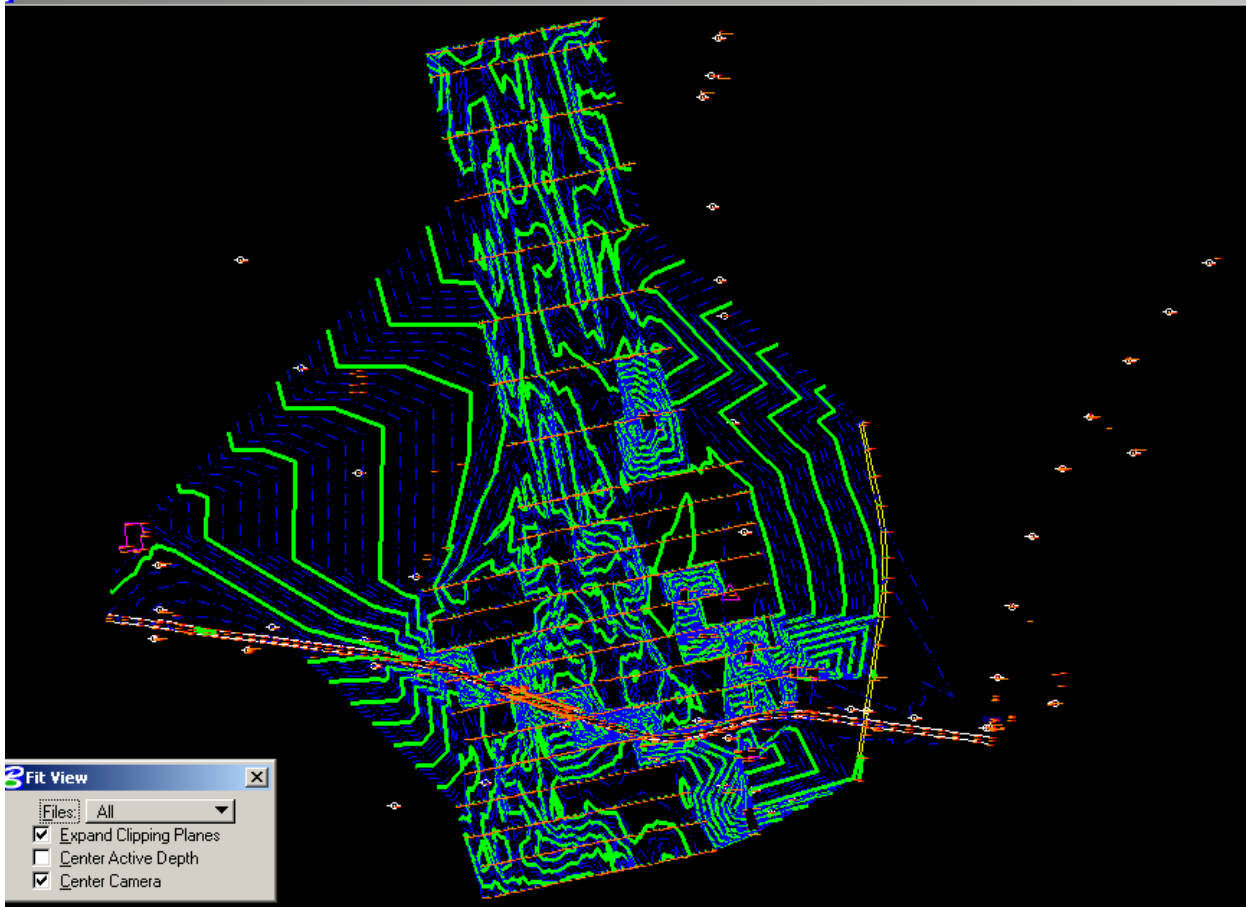

K-11. Descriptor Codes

The following list contains the library of descriptor codes used on topographic phase of this project.

TOTAL STATION:
NIKON DTM-550
SERIAL NO. 010175

LEVEL:
ZEISS NI2
SERIAL NO. 101670

Field Descriptor Codes

AC AC; TOP OF A.C. PAD	CND CND; CONDUIT	ESL ESL; EDGE OF SLAG ROAD
AP AP; ABANDONED PIPE	CNL CNL; CANAL	ESP ESP; EDGE SHEET PILE
APR APR; APRON	COH COH; CONCRETE HEAD WALL	ESR ESR; EDGE SHELL ROAD
ASP ASP; ASPHALT	CON CON; CONCRETE	EW EW; EDGE WOODS
ATO ATO; ABUTMENT TOE	COR COR; CORNER	FEP FEP; FENCE POST
ATP ATP; ABUTMENT TOP	CP CP; CYPREMERLE TREE	FC FC; FENCE CORNER
BBP BBP; BOTTOM OF BORROW PIT	CPG CPG; CONCRETE PILING	FIP FIP; 4" POST
BBT BBT; BOTTOM OF BENT	CPT CPT; CYPRESS TREE	FL FL; FENCE LINE
BCR BCR; BRIDGE CORNER	CRD CRD; CROWN OF DIKE	FLB FLB; FENCE LINE BRICK
BFB BFB; BRICK FLOWER BED	CRK CRK; CENTERLINE ROCK	FLC FLC; FENCE LINE CHAIN LINK FENCE
BF BF; BRIDGE FENDER	CRA CRA; CENTERLINE OF RAIL	FLD FLD; FLOOD WALL
BL BL; BASELINE	CRB CRB; CURB	FLW FLW; FENCE LINE WOODEN
BM BM; BENCH MARK	CR CR; CROWN OF LEVEE	FP FP; FLY POINT
BLD BLD; BUILDING	CRN CRN; CROWN	FS FS; FLOOD SIDE LEVEE
BLK BLK; BULKHEAD	CRT CRT; CROSSTIE	FSC FSC; FLOOD SIDE CROWN
BNT BNT; BENT OF BRIDGE	CRW CRW; CONCRETE RETAINING WALL	FST FST; FLOOD SIDE TOE
BOD BOD; BOTTOM OF DITCH	CSP CSP; CONCRETE AT SWIMMING POOL	FTG FTG; FOOTING
BOS BOS; BOTTOM OF STREAM	CTD CTD; CENTER OF DRAIN	GAC GAC; GROUND AT CULVERT
BOT BOT; BOTTOM	CTH CTH; CATCH BASIN	GAP GAP; GROUND AT PIER
BRC BRC; BRIDGE CONCRETE	CTN CTN; COTTONWOOD TREE	GAT GAT; GATE
BRF BRF; BRIDGE FENDER	CUB CUB; BOTTOM OF CULVERT	GGE GGE; GAGE
BRK BRK; BREAKLINE	CUL CUL; CULVERT	GL GL; GAS LINE
BRW BRW; BREAK WALL	CYP CYP; CYPRESS TREE	GM GM; GAS METER
BS BS; BUSH	CYS CYS; CYPRESS TREES	GRN GRN; GROUND
BW BW; BRICK WALL	DGS DGS; DOGWOOD TREES	GR GR; GUARD RAIL
CAR CAR; CENTERLINE OF AGGREGATE ROAD	DKE DKE; DIKE	GRV GRV; GRAVEL
CAP CAP; CONCRETE APRON	DRI DRI; DROP INLET	GTB GTB; GAS TEST BOX
CA CA; CONCRETE ASPHALT	DRN DRN; DRAIN	GUY GUY; GUY WIRE
CB CB; CATCH BASIN	DRV DRV; DRIVE	GVL GVL; GAS VALVE
CBC CBC; CABLE LINE	EAR EAR; EDGE OF AGGREGATE ROAD	HBK HBK; HIGH BANK
CBK CBK; CONCRETE BULKHEAD	EBR EBR; EDGE CONCRETE BRIDGE	HBS HBS; HACKBERRY TREES
CBL CBL; CABLE	EC EC; EDGE CONCRETE	HED HED; HEDGES
CBT CBT; CONCRETE BLUT TOE	ECC ECC; EDGE CONCRETE CURB	HL HL; HEDGE LINE
CCL CCL; CENTERLINE OF CONCRETE CULVERT	ECR ECR; EDGE CONCRETE ROAD	HSE HSE; HOUSE
CCP CCP; CENTERLINE OF CONCRETE PAD	ECW ECW; EDGE OF WALL	HT HT; 10" HACKBERRY TREE
CCR CCR; CENTERLINE OF CONCRETE CURB	EDR EDR; EDGE OF DIRT ROAD	HUB HUB; HUB
CDR CDR; CONCRETE DRIVE	EFB EFB; EDGE OF FLOWER BED	HWL HWL; HEAD WALL
CFP CFP; CORNER FLAG POLE BASE	EGL EGL; EDGE OF GRASS LINE	HYD HYD; FIRE HYDRANT
CG CG; CATTLE GUARD	ELS ELS; EDGE OF LIMESTONE	INV INV; PIPE INVERT
CH CH; CORNER HOUSE	ELM ELM; ELM TREE	IP IP; IRON PIPE
CHW CHW; CENTERLINE OF HEAD WALL	ELS ELS; ELM TREES	IRL IRL; IRON RAIL
CLG CLG; CENTERLINE GABION	EMG EMG; EDGE OF METAL GRATING	IR IR; IRON ROD
CL CL; CENTERLINE	EOA EOA; EDGE OF ASPHALT	LC LC; LOW CORD
CLB CLB; CENTERLINE OF BRIDGE	EOB EOB; EDGE OF BRIDGE	LPL LPL; LIGHT POLE
CLC CLC; CENTER OF CONCRETE	EOC EOC; EDGE OF CULVERT	LW LW; LOW WIRE
CLD CLD; CENTER OF DITCH	EOR EOR; EDGE OF RIP RAP	MB MB; MULLBERRY TREE
CLI CLI; CENTERLINE	EOM EOM; EDGE OF MEDIAN	MBX MBX; MAIL BOX
CLR CLR; CENTERLINE OF ROAD	EP EP; EDGE OF PLATFORM	MET MET; METAL; TOP OF GATES
CLW CLW; CENTERLINE OF WALKWAY	EPL EPL; EDGE OF PARKING LOT	MF MF; MUD FLAT
	ER ER; EDGE OF ROAD	MGT MGT; MAGNOLIA TREE
	ERF ERF; EDGE OF ROAD FLOOD SIDE	MH MH; MANHOLE COVER
	ERP ERP; EDGE OF ROAD PROTECTED SIDE	MON MON; MONUMENT
	ESH ESH; EDGE SHELL ROAD	MSH MSH; MARSH
		MTR MTR; METER
		MTX MTX; METER BOX
		NG NG; NATURAL GROUND
		NGP NGP; NATURAL GROUND AT PILING

EM 1110-1-1005
1 Jan 06

NS NS; NORTH SIDE	SS SS; SOUTH SIDE	TP TP; TOP OF OLD RR BED
OH OH; OVERHEAD POWER LINES	SHD SHD; SHOULDER	TPB TPB; TOP OF BERM
OT OT; OAK TREE	SP SP; SHEET PILING	TPL TPL; TELEPHONE POLE
OTS OTS; OAK TREES	SHL SHL; SHELL	TPR TPR; TOP ROCK
PC PC; PECAN TREE	SLP SLP; SLOPE SHOT	TPT TPT; TOP SETTLEMENT PLATE
PCS PCS; PECAN TREES	SND SND; SOUNDINGS	TPW TPW; TOP OF CONCRETE WING WALL
PIC PIC; PIPE INVERT, CONCRETE	SNG SNG; SOUNDINGS	TR TR; TREE
PIM PIM; PIPE INVERT, CMP	SOC SOC; SLOPE ON CONCRETE	TRA TRA; TOE OF GUARD RAIL
PIN PIN; PIPE INVERT	SRR SRR; SLOPE ON RIP RAP	TRL TRL; TREE LINE
PIP PIP; PIPE INVERT, PLASTIC	SPT SPT; TOE OF SHEET PILING	TRN TRN; TRANSFORMER
PIR PIR; PIER	SPV SPV; SLOPE PAVING	TRW TRW; TOE OF CONCRETE RETAINING WALL
PIS PIS; PIPE INVERT, STEEL	STP STP; STEPS	TSP TSP; TOP OF THE SHEET PILING
PL PL; PIPELINE CROSSING	SWK SWK; SIDEWALK	TWB TWB; TOP WOOD BANK
PLC PLC; POWER LINE CROSSING	TEP TEP; TELEPHONE PEDESTAL	TWR TWR; TOWER
PLG PLG; PILING	TB TB; TOE OF OLD RR BED	TWW TWW; TOE OF CONCRETE WING WALL
PLT PLT; PLATFORM	TBK TBK; TOP OF BANK	UBX UBX; UTILITY BOX
POR POR; PORCH	TBL TBL; TOE OF BALLAST	UGT UGT; UNDERGROUND TELEPHONE LINE
PPE PPE; PIPE	TBP TBP; TOP OF BORROW PIT	UTL UTL; UTILITIES
PPL PPL; POWER POLE	TBR TBR; TOE OF BERM	VAL VAL; VALVE
PP PP; PICTURE POINT	TBS TBS; TOP OF BALLAST	WF WF; WATER FAUCET
PRK PRK; PIPE RACK	TC TC; TOP CONCRETE	WLN WLN; WATER LINE
PSC PSC; PROTECTED SIDE CROWN	TCB TCB; TOP CONCRETE BANK	WBT WBT; WOOD BANK TOE
PST PST; PROTECTED SIDE TOE	TCR TCR; TOE CURB	WBK WBK; WOOD BULKHEAD
PS PS; PROTECTED SIDE LEVEE	TCS TCS; TOP OF CONCRETE PAVEMENT (ON SLOPE)	WDP WDP; WOOD PILING
PT PT; 10" PINE TREE	TCW TCW; TOP OF CONCRETE WALL	WE WE; WATER EDGE
PTS PTS; PINE TREES	TEC TEC; TOP ON EDGE OF CONCRETE WALL	WES WES; WATER EDGE SURFACE
PVC PVC; PVC PIPE	TED TED; TOP EDGE OF DITCH	WFL WFL; WOOD FENCE LINE
PWC PWC; 4" POST WITH CABLE	THR THR; THRESHOLD	WL WL; WOODLINE
PWL PWL; POWERLINE	TIP TIP; 3" POST	WLK WLK; WALKWAY
RAL RAL; GUARD RAIL	TNK TNK; TANK	WLS WLS; WILLOW TREES
RCK RCK; ROCK	TOB TOB; TOE OF BORROW PIT	WM WM; WATER MAIN - METER
RCP RCP; INV. RCP	TOC TOC; TOE OF CONCRETE WALL	WMA WMA; WATER MAIN HOLE
RD RD; ROAD	TOD TOD; TOE OF DITCH	WRW WRW; WOODEN RETAINING WALL
RMP RMP; RAMP	TOE TOE; TOE ON NATURAL GROUND	WS WS; WATER SURFACE
RDM RDM; RED DAY MARKER	TOL TOL; TOP OF LEVEE	WSB WSB; WISTERA BUSH
ROW ROW; RIGHT OF WAY	TOP TOP; TOP ON NATURAL GROUND	WV WV; WATER VALVE
RP RP; RIP RAP	TOR TOR; TOE ROCK	WW WW; WING WALL
RRP RRP; RAILROAD POST	TOW TOW; TOP OF WALL	XBR XBR; BRIDGE CROSS BRACE
SCO SCO; SEWER CLEAR OUT	TPC TPC; TOP CURB	
SGN SGN; SIGN	TEL TEL; TELEPHONE LINE	
SGP SGP; SIGN POST		

Appendix L Glossary

L-1. Abbreviations and Acronyms

1D	One Dimensional
2D	Two-dimensional
2DRMS	Twice the distance root mean square
3D	Three-dimensional
A-E	Architect-Engineer
A/E/C.....	Architect/Engineer/Construction
ACSM.....	American Congress on Surveying and Mapping
ADA	Air Defense Artillery
AFB	Air Force Base
ALTA	American Land Title Association
AM/FM.....	Automated Mapping/ Facility Mapping
AOC	Aircraft Obstruction Surveys
ARP	Antenna Reference Point
ASCE.....	American Society of Civil Engineers
ASPRS.....	American Society for Photogrammetry and Remote Sensing
BFE.....	Base Flood Elevation
BLM	Bureau of Land Management
BS	Backsight
CADD.....	Computer Aided Drafting and Design
CAiCE	Computer Aided Civil Engineering
CALTRANS	California Department of Transportation
CEFMS.....	Corps of Engineers Financial Management System
COGO.....	Coordinate Geometry
CONUS.	CONtinental United States
CORPSCON	CORPS CONvert
CORS	Continuously Operating Reference Stations
COR.....	Contracting Officer's Representative
DA	Department of the Army
DE.....	Difference in Elevation
DEM	Digital Elevation Model
DOD	Department of Defense
DOT.....	Department of Transportation
DFARS.	Defense Federal Acquisition Regulation Supplement
DGPS.....	Differential Global Positioning System
DTM	Digital Terrain Model
EAC	Echelons Above Corps
EDM	Electronic Distance Measurement
EFARS.....	Engineer Federal Acquisition Regulation Supplement
EM.....	Engineer Manual
ERM	Elevation Reference Mark
ERDC	Engineer Research and Development Center
E&D.	Engineering and Design
FA.....	Field Artillery
FAA	Federal Aviation Administration
FAC	Florida Administrative Code

EM 1110-1-1005
1 Jan 07

FAR	Federal Acquisition Regulations
FAR	Federal Aviation Regulation
FEMA	Federal Emergency Management Agency
FFP	Firm Fixed Price
FGCS	Federal Geodetic Control Subcommittee
FGDC	Federal Geographic Data Committee
FIRM	Flood Insurance Rate Map
FIS	Flood Insurance Study
FLSA	Fair Labor Standards Act
FM	Field Manual
FMSFIE	Facility Management Standard for Facilities, Infrastructure, and Environment
FOA	Field Operating Activity
FS	Foresight
G&A	General and Administrative
GDOP	Geometric Dilution of Position
GIS	Geographic Information System
GPS	Global Positioning System
GRS 80	Geodetic Reference System of 1980
GS	General Support
GSA	General Services Administration
GZD	Grid Zone Designator
HARN	High Accuracy Regional Networks
HI	Height of Instrument
HDOP	Horizontal Dilution of Position
HPGN	High Precision Geodetic Networks
HR	Height of Reflector
HT	Height of Target
HTRW	Hazardous, Toxic, or radioactive Waste
HQUSACE	Headquarters, US Army Corps of Engineers
IDC	Indefinite Delivery Contract
IERS	International Earth Rotation Service
IGE	Independent Government Estimate
IGLD 55	International Great Lakes Datum of 1955
IGLD 85	International Great Lakes Datum of 1985
ILS	Instrument Landing System
INT	Intersection
ITL	Information Technology Lab
ITRF	International Terrestrial Reference Frame
JTR	Joint Travel Regulation
KO	Contracting Officer
LCC	Lambert Conformal Conic
LEC	Linear Error of Closure
LIDAR	LIght Detection And Ranging
LWRP	Low Water Reference Plane
MACOM	Major Army Command
MDL	MicroStation Design Language
MGRS	Military Grid-Reference System
MHW	Mean High Water
MLLW	Mean Lower Low Water
MLRS	Multiple Launch Rocket System
MLS	Microwave Landing System

MSL.....	Mean Sea Level
MSL1912.....	Mean Sea Level Datum of 1912
NAD 27	North American Datum of 1927
NAD 83	North American Datum of 1983
NADCON	North American Datum Conversion
NAS	National Airspace System
NAVAID	Navigation Aid
NAVD 88	North American Vertical Datum 1988
NDGPS.....	Nationwide Differential GPS
NFIP	National Flood Insurance Program
NGRS	National Geodetic Reference System
NGS	National Geodetic Survey
NGVD 29	National Geodetic Vertical Datum 1929
NMAS	National Map Accuracy Standard
NMP	National Mapping Program
NOAA	National Oceanic and Atmospheric Administration
NOS	National Ocean Service
NSRS	National Spatial Reference System
NSSDA.....	National Standard for Spatial Data Accuracy
NVCN.....	National Vertical Control Network
OCONUS	Outside the Continental United States
OHWM.....	Ordinary High Water Mark
OPUS.....	On-Line Positioning User Service
OTF	On-the-Fly
P&S	Plans and Specifications
PADS.....	Position and Azimuth Determination System
PBM	Permanent Benchmark
PDOP.....	Position Dilution of Position
PDSC	Professional Development Support Center
PI	Point of Intersection
PLGR.....	Precise Lightweight Geodetic Receiver
PM	Project Manager or Management
POB	Point of Beginning
POI	Point on Line
POT	Point of Tangency
PPRTK	Post-Processed Real-Time Kinematic
ppm.....	Parts per Million
PR&C	Purchase Request & Commitment
PRIP	Plant Replacement and Improvement Program
PROSPECT	Proponent Sponsored Engineer Corps Training
PVT	Point of Vertical Tangent
QA	Quality Assurance
QC	Quality Control
RFP.....	Request for Proposal
RMS	Root mean Square
RMSE.....	Root Mean Square Error
RTK.....	Real Time Kinematic
SCP.....	Survey Control Point
SDSFIE.....	Spatial Data Standard for Facilities, Infrastructure, and Environment
SDTS	Spatial Data Transfer Standard
SI	International System of Units

EM 1110-1-1005
1 Jan 07

SOW	Scope or Statement of Work
SPCE	Survey Planning and Coordination Element
SPCS	State Plane Coordinate System
TA.....	Target Acquisition
TBM	Temporary Benchmark
TDS	Tripod Data Systems
TDSE.....	Touchdown Zone Elevation
TEC	Topographic Engineering Center
TIN	Triangular Irregular Network
TM.....	Transverse Mercator
TGO.....	Trimble Geomatics Office
TP	Turning Point
TSC.....	Trimble Survey Controller
US.....	United States
USACE	US Army Corps of Engineers
USARC.....	US Army Reserve Center
USC&GS	US Coast & Geodetic Survey
USCG	US Coast Guard
USFS	US Forest Service
USGS.....	US Geological Survey
USNAVOCEANO.....	US Navy Oceanographic Office
USNG	US National Grid
UTM	Universal Transverse Mercator
VDOP	Vertical Dilution of Position
VERTCON	VERTical CONversion
VLBI.....	Very-Long-Baseline-Interferometry
WAAS	Wide Area Augmentation System
WGS 84	World Geodetic System of 1984
WRDA.....	Water Resources Development Act
XREF.....	External Reference
ZD.....	Zenith Distance

L-2. Terms

Absolute or Autonomous GPS

Operation with a single receiver for a desired position. This receiver may be positioned to be stationary over a point. This mode of positioning is the most common military and civil application.

Accuracy

The degree to which an estimated (mean) value is compatible with an expected value. Accuracy implies the estimated value is unbiased.

Adjustment

Adjustment is the process of estimation and minimization of deviations between measurements and a mathematical model.

Altimeter

An instrument that measures elevation differences usually based on atmospheric pressure measurements.

Altitude

The vertical angle between the horizontal plane of the observer and a directional line to the object.

Angle of Depression

A negative altitude.

Angle of Elevation

A positive altitude.

Angular Misclosure

Difference in the actual and theoretical sum of a series of angles.

Archiving

Storing of documents and information.

Astronomical Latitude

Angle between the plumb line and the plane of celestial equator. Also defined as the angle between the plane of the horizon and the axis of rotation of the earth. Astronomical latitude applies only to positions on the earth and is reckoned from the astronomic equator, north and south through 90E. Astronomical latitude is the latitude that results directly from observations of celestial bodies, uncorrected for deflection of the vertical.

Astronomical Longitude

Arbitrarily chosen angle between the plane of the celestial meridian and the plane of an initial meridian. Astronomical longitude is the longitude that results directly from observations on celestial bodies, uncorrected for deflection of the vertical.

Astronomical Triangle

A spherical triangle formed by arcs of great circles connecting the celestial pole, the zenith and a celestial body. The angles of the astronomical triangles are: at the pole, the hour angle; at the celestial body, the parallactic angle; at the zenith, the azimuth angle. The sides are: pole to zenith, the co-latitude; zenith to celestial body, the zenith distance; and celestial body to pole, the polar distance.

Atmospheric Refraction

Refraction of electromagnetic radiation through the atmosphere causing the line-of-sight to deviate from a straight path. Mainly temperature and pressure conditions determine the magnitude and direction of curvature affecting the path of light from a source. Refraction causes the ray to follow a curved path normal the surface gradient.

Azimuth

The horizontal direction of a line clockwise from a reference plane, usually the meridian. Often called forward azimuth to differentiate from back azimuth.

Azimuth Angle

The angle less than 180° between the plane of the celestial meridian and the vertical plane with the observed object, reckoned from the direction of the elevated pole. In astronomic work, the azimuth angle is the spherical angle at the zenith in the astronomical triangle, which is composed of the pole, the zenith and the star. In geodetic work, it is the horizontal angle between the celestial pole and the observed terrestrial object.

Azimuth Closure

Difference in arc-seconds of the measured or adjusted azimuth value with the true or published azimuth value.

Backsight

A sight on a previously established traverse or triangulation station and not the closing sight on the traverse. A reading on a rod held on a point whose elevation has been previously determined.

Barometric Leveling

Determining differences of elevation from measured differences of atmospheric pressure observed with a barometer. If the elevation of one station above a datum is known, the approximate elevations of other station can be determined by barometric leveling. Barometric leveling is widely used in reconnaissance and exploratory surveys.

Baseline

Resultant three-dimensional vector between any two stations with respect to a given coordinate system. The primary reference line in a construction system.

Base net

The primary baseline used for densification of survey stations to form a network.

Base Points

The beginning points for a traverse that will be used in triangulation or trilateration.

Base Control

The horizontal and vertical control points and coordinates used to establish a base network. Base control is determined by field surveys and permanently marked or monumented for further surveys.

Bearing

The direction of a line with respect to the meridian described by degrees, minutes, and seconds within a quadrant of the circle. Bearings are measured clockwise or counterclockwise from north or south, depending on the quadrant.

Benchmark

A permanent material object, natural or artificial, on a marked point of known elevation.

Best Fit

To represent a given set of points by a smooth function, curve, or surface which minimizes the deviations of the fit.

Bipod

A two-legged support structure for an instrument or survey signal at a height convenient for the observer.

Bluebook

Another term for the "FGCS Input Formats and Specifications of the National Geodetic Data Base".

Blunder

A mistake or gross error.

Bureau International de l'Heure

The Bureau was founded in 1919 and its offices since then have been at the Paris Observatory. By an action of the International Astronomical Union, the BIH ceased to exist on 1 January 1988 and a new organization, the International Earth Rotation Service (IERS) was formed to deal with determination of the Earth's rotation.

Cadastral Survey

Relates to land boundaries and subdivisions, and creates units suitable for transfer or to define the limitations of title. The term cadastral survey is now used to designate the surveys of the public lands of the US, including retracement surveys for identification and resurveys for the restoration of property lines; the term can also be applied properly to corresponding surveys outside the public lands, although such surveys are usually termed land surveys through preference.

Calibration

Determining the systematic errors in an instrument by comparing measurements with correct values. The correct value is established either by definition or by measurement with a device that has itself been calibrated or of much higher precision.

Cartesian Coordinates

A system with its origin at the center of the earth and the x and y and z axes in the plane of the equator. Typically, the x-axis passes through the meridian of Greenwich, and the z-axis coincides with the earth's axis of rotation. The three axes are mutually orthogonal and form a right-handed system.

Cartesian System

A coordinate system consisting of axes intersecting at a common point (origin). The coordinate of a point is the orthogonal distance between that point and the hyperplane determined by all axes. A Cartesian coordinate system has all the axes intersecting at right angles, and the system is called a rectangular.

Celestial Equator

A great circle on the celestial sphere with equidistant points from the celestial poles. The plane of the earth's equator, if extended, would coincide with that of the celestial equator.

Celestial pole

A reference point at the point of intersection of an indefinite extension of the earth's axis of rotation and the apparent celestial sphere.

Celestial sphere

An imaginary sphere of infinite radius with the earth as a center. It rotates from east to west on a prolongation of the earth's axis.

Central Meridian

A line of constant longitude at the center of a graticule. The central meridian is used as a base for constructing the other lines of the graticule. The meridian is used as the y-axis in computing tables for a State Plane Coordinate system. That line, on a graticule, which represents a meridian and which is an axis of symmetry.

Chain

Equal to 66 feet or 100 links. The unit of length prescribed by law for the survey of the US public lands. One acre equals 10 square chains.

Chained Traverse

Observations and measurements performed with tape.

Chaining

Measuring distances on the ground with a graduated tape or with a chain.

Chart Datum

Reference surface for soundings on a nautical chart. It is usually taken to correspond to a low water elevation, and its depression below mean sea level is represented by the symbol Z_0 . Since 1989, chart datum has been implemented to mean lower low water for all marine waters of the US its territories, Commonwealth of Puerto Rico and Trust Territory of the Pacific Islands.

Chi-square Testing

Non-parametric statistical test used to classify the shape of the distribution of the data.

Chronometer

A portable timekeeper with compensated balance, capable of showing time with extreme precision and accuracy.

Circle Position

A prescribed setting (reading) of the horizontal circle of a direction theodolite, to be used for the observation on the initial station of a series of stations that are to be observed.

Circuit Closure

Difference between measured or adjusted value and the true or published value.

Clarke 1866 Ellipsoid

The reference ellipsoid used for the NAD 27 horizontal datum. It is a non-geocentric ellipsoid formerly used for mapping in North America.

Closed Traverse

Starts and ends at the same point or at stations whose positions have been determined by other surveys.

Collimation

A physical alignment of a survey target or antenna over a mark or to a reference line.

Collimation Error

The angle between the actual line of sight through an optical instrument and an alignment.

Compass Rule

The correction applied to the departure (or latitude) of any course in a traverse has the same ratio to the total misclosure in departure (or latitude) as the length of the course has to the total length of the traverse.

Confidence Level

Statistical probability (in percent) based on the standard deviation or standard error associated with the normal probability density function. The confidence level is assigned according to an expansion factor multiplied by the magnitude of one standard error. The expansion factor is based on values found in probability tables at a chosen level of significance.

Conformal

Map projection that preserves shape.

Contour

An imaginary line on the ground with all points at the same elevation above or below a specified reference surface.

Control

Data used in geodesy and cartography to determine the positions and elevations of points on the earth's surface or on a cartographic representation of that surface. A collective term for a system of marks or objects on the earth or on a map or a photograph whose positions or elevation are determined.

Control Densification

Addition of control throughout a region or network.

Control Monuments

Existing local control or benchmarks that may consist of any Federal, state, local or private agency points.

Control Point

A point with assigned coordinates is sometimes used as a synonym for control station. However, a control point need not be realized by a marker on the ground.

Control Survey

A survey which provides coordinates (horizontal or vertical) of points to which supplementary surveys are adjusted.

Control Traverse

A survey traverse made to establish control.

Conventional Terrestrial Pole (CTP)

The origin of the WGS 84 Cartesian system is the earth's center of mass. The Z-axis is parallel to the direction of the CTP for polar motion, as defined by the Bureau of International de l'Heure (BIH), and equal to the rotation axis of the WGS 84 ellipsoid. The X-axis is the intersection of the WGS 84 reference meridian plane and the CTP's equator, the reference meridian being parallel to the zero meridian defined by the BIH and equal to the X-axis of the WGS 84 ellipsoid. The Y-axis completes a right-handed, earth-centered, earth-fixed orthogonal coordinate system, measured in the plane of the CTP equator 90 degrees east of the X-axis and equal to the Y-axis of the WGS 84 ellipsoid.

Coordinate Transformation

A mathematical process for obtaining a modified set of coordinates through some combination of rotation of coordinate axes at their point of origin, change of scale along coordinate axes, or translation through space

CORPSCON

(Corps Convert) Software package (based on NADCON) capable of performing coordinate transformations between NAD 83 and NAD 27 datums.

Crandall Method

Traverse misclosure in azimuth or angle is first distributed in equal portions to all the measured angles. The adjusted angles are then held fixed and all remaining coordinate corrections distributed among the distance measurements.

Cross sections

A survey line run perpendicular to the alignment of a project, channel or structure.

Curvature

The rate at which a curve deviates from a straight line. The parametric vector described by dt/ds , where t is the vector tangent to a curve and s is the distance along that curve.

Datum

Any numerical or geometrical quantity or set of such quantities which serve as a reference or base for other quantities.

Declination

The angle, at the center of the celestial sphere, between the plane of the celestial equator and a line from the center to the point of interest (on a celestial body).

Deflection of the Vertical

The spatial angular difference between the upward direction of a plumb line and the normal to the reference ellipsoid. Often expressed in two orthogonal components in the meridian and the prime vertical directions.

Deflection Traverse

Direction of each course measured as an angle from the direction of the preceding course.

Deformation Monitoring

Observing the movement and condition of structures by describing and modeling its change in shape.

Departure

The orthogonal projection of a line onto an east-west axis of reference. The departure of a line is the difference of the meridional distances or longitudes of the ends of the line.

Differential GPS

Process of measuring the differences in coordinates between two receiver points, each of which is simultaneously observing/measuring satellite code ranges and/or carrier phases from the NAVSTAR GPS constellation. Relative positioning with GPS can be performed by a static or kinematic modes.

Differential Leveling

The process of measuring the difference of elevation between any two points by spirit leveling.

Direction

The angle between a line or plane and an arbitrarily chosen reference line or plane. At a triangulation station, observed horizontal angles are referred to a common reference line and termed horizontal direction. A line, real or imaginary, pointing away from some specified point or locality toward another point. Direction has two meanings: that of a numerical value and that of a pointing line.

Direct Leveling

The determination of differences of elevation through a continuous series of short horizontal lines. Vertical distances from these lines to adjacent ground marks are determined by direct observations on graduated rods with a leveling instrument equipped with a spirit level.

Distance Angle

An angle in a triangle opposite a side used as a base in the solution of the triangle, or a side whose length is to be computed.

Dumpy Level

The telescope permanently attached to the leveling base, either rigidly to by a hinge that can be manipulated by a micrometer screw.

Earth-Centered Ellipsoid

Center at the Earth's center of mass and minor semi-axis coincident with the Earth's axis of rotation.

Easting

The distance eastward (positive) or westward (negative) of a point from a particular meridian taken as reference.

Eccentricity

The ratio of the distance from the center of an ellipse to its focus on the major semi-axis.

Electronic Distance Measurement (EDM)

Timing or phase comparison of electro-magnetic signal to determine an interferometric distance.

Elevation

The height of an object above some reference datum.

Ellipsoid

Formed by revolving an ellipse about its minor semi-axis. The most commonly used reference ellipsoids in North America are: Clarke 1866, Geodetic Reference System of 1980 (GRS 80), World Geodetic System of 1972 (WGS 72) and World Geodetic System of 1984 (WGS 84).

Ellipsoid height

The magnitude h of a point above or below the reference ellipsoid measured along the normal to the ellipsoid surface.

Error

The difference between the measured value of a quantity and the theoretical or defined value of that quantity.

Error Ellipse

An elliptically shaped region with dimensions corresponding to a certain probability at a given confidence level.

Error of Closure

Difference in the measured and predicted value of the circuit along the perimeter of a geometric figure.

Finite Element Method

Obtaining an approximate solution to a problem for which the governing differential equations and boundary conditions are known. The method divides the region of interest into numerous, interconnected sub-regions (finite elements) over which simple, approximating functions are used to represent the unknown quantities.

Fixed Elevation

Adopted as a result of tide observations or previous adjustment of spirit leveling, and which is held at its accepted value in any subsequent adjustment.

Foresight

An observation to the next instrument station. The reading on a rod that is held at a point whose elevation is to be determined.

Frequency

The number of complete cycles per second existing in any form of wave motion.

Geodesic Line

Shortest distance between any two points on any mathematically defined surface.

Geodesy

Determination of the time-varying size and figure of the earth by such direct measurements as triangulation, leveling and gravimetric observations.

Geodetic Control

Established and adjusted horizontal and/or vertical control in which the shape and size of the earth have been considered in position computations.

Geodetic Coordinates

Angular latitudinal and longitudinal coordinates defined with respect to a reference ellipsoid.

Geodetic Height

See Ellipsoid height.

Geodetic Latitude

The angle which the normal at a point on the reference ellipsoid makes with the plane of the equator.

Geodetic Leveling

The observation of the differences in elevation by means of a continuous series of short horizontal lines of sight.

Geodetic Longitude

The angle subtended at the pole between the plane of the geodetic meridian and the plane of a reference meridian (Greenwich).

Geodetic North

Direction tangent to a meridian pointing toward the pole defining astronomic north, also called true north.

Geodetic Reference System of 1980

Reference ellipsoid used to establish the NAD 83 system of geodetic coordinates.

Geoid

An equipotential surface of the gravity field approximating the earth's surface and corresponding with mean sea level in the oceans and its extension through the continents.

GPS (Global Positioning System)

DoD satellite constellation providing range, time, and position information through a GPS receiver system.

Gravimeter

Instrument for measuring changes in gravity between two points.

Gravity

Combined acceleration potential of an object due to gravitation and centrifugal forces.

Greenwich Meridian

The astronomic meridian through the center of the Airy transit instrument of the Greenwich Observatory, Greenwich, England. By international agreement in 1884, the Greenwich meridian was adopted as the meridian from which all longitudes, worldwide, would be calculated.

Grid Azimuth

The angle in the plane of projection between a straight line and the line (y-axis) in a plane rectangular coordinate system representing the central meridian. While essentially a map-related quantity, a grid azimuth may, by mathematical processes, be transformed into a survey- related or ground-related quantity.

Grid Inverse

The computation of length and azimuth from coordinates on a grid.

Grid Meridian

Line parallel to the line representing the central meridian or y-axis of a grid on a map. The map line parallel to the line representing the y-axis or central meridian in a rectangular coordinate system.

Gunter's Chain

A measuring device once used in land surveying. It was composed of 100 metallic links fastened together with rings. The total length of the chain is 66 feet. Also called a four-pole chain.

Gyrotheodolite

A gyroscopic device used to measure azimuth that is built-in or attached to a theodolite.

Histogram

A graphical representation of relative frequency of an outcome partitioned by class interval. The frequency of occurrence is indicated by the height of a rectangle whose base is proportional to the class interval.

EM 1110-1-1005
1 Jan 07

Horizontal Control

Determines horizontal positions with respect to parallels and meridians or to other lines of reference.

Hour Circle

Any great circle on the celestial sphere whose plane is perpendicular to the plane of the celestial equator.

Index Error

A systematic error caused by deviation of an index mark or zero mark on an instrument having a scale or vernier, so that the instrument gives a non-zero reading when it should give a reading of zero. The distance error from the foot of a leveling rod to the nominal origin (theoretical zero) of the scale.

Indirect Leveling

The determination of differences of elevation from vertical angles and horizontal distances.

Interior Angle

An angle between adjacent sides of a closed figure and lying on the inside of the figure. The three angles within a triangle are interior angles.

International Foot

Defined by the ratio 30.48/100 meters.

International System of Units (SI)

A self-consistent system of units adopted by the general Conference on Weights and Measures in 1960 as a modification of the then-existing metric system.

Interpolation Method

Determination of a intermediate value between given values using a known or assumed rate of change of the values between the given values.

Intersection

Determining the horizontal position of a point by observations from two or more points of known position. Thus measuring directions or distances that intersect at the station being located. A station whose horizontal position is located by intersection is known as an intersection station.

Intervisibility

When two stations are visible to each other in a survey net.

Invar

An alloy of iron containing nickel, and small amounts of chromium to increase hardness, manganese to facilitate drawing, and carbon to raise the elastic limit, and having a very low coefficient of thermal expansion (about 1/25 that of steel).

Isogonic Chart

A system of isogonic lines, each for a different value of the magnetic declination.

Isogonic Line

A line drawn on a chart or map and connecting all points representing points on the earth having equal magnetic declination at a given time.

Laplace Azimuth

A geodetic azimuth derived from an astronomic azimuth by use of the Laplace equation.

Laplace Condition

Arises from the fact that a deflection of the vertical in the plane of the prime vertical will give a difference between astronomic and geodetic longitude and between astronomic and geodetic azimuth. Conversely, the observed differences between astronomic and geodetic values of the longitude and of the azimuth may both be used to determine the deflection in the plane of the prime vertical.

Laplace Equation

Expresses the relationship between astronomic and geodetic azimuths in terms of astronomic and geodetic longitudes and geodetic latitude.

Laplace Station

A triangulation or traverse station at which a Laplace azimuth is determined. At a Laplace station both astronomic longitude and astronomic azimuth are determined.

Least Count

The finest reading that can be made directly (without estimation) from a vernier or micrometer.

Least Squares Adjustment

The adjustment of the values of either the measured angles or the measured distances in a traverse using the condition that the sum of the squares of the residuals is a minimum.

Level

Any device sensitive to the direction of gravity and used to indicate directions perpendicular to that of gravity at a point.

Level Datum

A level surface to which elevations are referred. The generally adopted level datum for leveling in the US is mean sea level. For local surveys, an arbitrary level datum is often adopted and defined in terms of an assumed elevation for some physical mark.

Level Net

Lines of spirit leveling connected together to form a system of loops or circuits extending over an area.

Line of Sight

The line extending from an instrument along which distant objects are seen, when viewed with a telescope or other sighting device.

Local Coordinate System

Where the coordinate system origin is assigned arbitrary values and is within the region being surveyed and used principally for points within that region.

Local Datum

Defines a coordinate system that is used only over a region of very limited extent.

Loop Traverse

A closed traverse that starts and ends at the same station. A pattern of measurements in the field, so that the final measurement is made at the same place as the first measurement.

Magnetic Bearing

The angle with respect to magnetic north or magnetic south stated as east or west of the magnetic meridian.

Magnetic Meridian

The vertical plane through the magnetic pole including the direction, at any point, of the horizontal component of the Earth's magnetic field.

Major Semi-Axis

The line from the center of an ellipse to the extremity of the longest diameter. The term is also used to mean the length of the line.

Map

A conventional representation, usually on a plane surface and at an established scale, of the physical features (natural, artificial, or both) of a part or whole of the Earth's surface by means of signs and symbols and with the means of orientation indicated.

Map Accuracy

The accuracy with which a map represents. Three types of error commonly occur on maps: errors of representation, which occur because conventional signs must be used to represent natural or man-made features such as forests, buildings and cities; errors of identification, which occur because a non-existent feature is shown or is misidentified; and errors of position, which occur when an object is shown in the wrong position. Errors of position are commonly classified into two types: errors of horizontal location and errors of elevation. A third type, often neglected, is errors of orientation.

Map Scale

The ratio of a specified distance on a map to the corresponding distance in the mapped object.

Mean Angle

Average value of the angles.

Mean Lower Low Water (MLLW)

The average height of all lower low waters recorded over a 19-year period.

Mean Sea Level Datum

Adopted as a standard datum for heights or elevations. The Sea Level Datum of 1929, the current standard for geodetic leveling in the United States, is based on tidal observations over a number of years at various tide stations along the coasts.

Metric Unit

Belonging to or derived from the SI system of units.

Micrometer

In general, any instrument for measuring small distances very accurately. In astronomy and geodesy, a device, for attachment to a telescope or microscope, consisting of a mark moved across the field of view by a screw connected to a graduated drum and vernier. If the mark is a hair-like filament, the micrometer is called a filar micrometer.

Minor Semi-Axis

The line from the center of an ellipse to the extremity of the shortest diameter. I.e., one of the two shortest lines from the center to the ellipse. The term is also used to mean the length of the line.

Misclosure

The difference between a computed and measured value.

Monument

A physical object used as an indication of the position on the ground of a survey station.

NADCON

The National Geodetic Survey developed the conversion program NADCON (North American Datum Conversion) to convert to and from North American Datum of 1983. The technique used is based on a bi-harmonic equation classically used to model plate deflections. NADCON works exclusively in geographical coordinates (latitude/longitude).

Nadir

The point directly beneath the instrument and directly opposite to the zenith or the lowest point.

National Geodetic Vertical Datum 1929

Formerly adopted as the standard geodetic datum for heights, based on an adjustment holding 26 primary tide stations in North America fixed.

National Map Accuracy Standards

Specifications of the accuracy required of topographic maps published by the US at various scales.

National Tidal Datum Epoch

A period of 19 years adopted by the National Ocean Survey as the period over which observations of tides are to be taken and reduced to average values for tidal datums.

Network

Interconnected system of surveyed points.

Non-SI units

Units of measurement not associated with International System of Units (SI).

North American Datum of 1927

Formerly adopted as the standard geodetic datum for horizontal positioning. Based on the Clarke ellipsoid of 1866, the geodetic positions of this system are derived from a readjustment of survey observations throughout North America.

North American Datum of 1983

Adopted as the standard geodetic datum for horizontal positioning. Based on the Geodetic Reference System of 1980, the geodetic positions of this system are derived from a readjustment of survey observations throughout North America.

North American Vertical Datum of 1988

Adopted as the standard geodetic datum for heights.

EM 1110-1-1005
1 Jan 07

Northing

A linear distance, in the coordinate system of a map grid, northwards from the east-west line through the origin (or false origin).

Open Traverse

Begins from a station of known or adopted position, but does not end upon such a station.

Optical Micrometer

Consists of a prism or lens placed in the path of light entering a telescope and rotatable, by means of a graduated linkage, about a horizontal axis perpendicular to the optical axis of the telescope axis. Also called an optical-mechanical compensator. The device is usually placed in front of the objective of a telescope, but may be placed immediately after it. The parallel-plate optical micrometer is the form usually found in leveling instruments.

Optical Plummet

A small telescope having a 90° bend in its optical axis and attached to an instrument in such a way that the line of sight proceeds horizontally from the eyepiece to a point on the vertical axis of the instrument and from that point vertically downwards. In use, the observer, looking into the plummet, brings a point on the instrument vertically above a specified point (usually a geodetic or other mark) below it.

Order of Accuracy

Defines the general accuracy of the measurements made in a survey. The order of accuracy of surveys are divided into four classes labeled: First Order, Second Order, Third Order and Fourth or lower order.

Origin

That point in a coordinate system which has defined initial coordinates and not coordinates determined by measurement. This point is usually given the coordinates (0,0) in a coordinate system in the plane and (0,0,0) in a coordinate system in space.

Orthometric Height

The elevation H of a point above or below the geoid.

Parallax

The apparent displacement of the position of a body, with respect to a reference point or system, caused by a shift in the point of observation.

Philadelphia Leveling Rod

Having a target but with graduations so styled that the rod may also be used as a self-reading leveling rod. Also called a Philadelphia rod. If a length greater than 7 feet is needed, the target is clamped at 7 feet and raised by extending the rod. When the target is used, the rod is read by vernier to 0.001 foot. When the rod is used as a self-reading leveling rod, the rod is read to 0.005 foot.

Photogrammetry

Deducing the physical dimensions of objects from measurements on photographs of the objects.

Picture Point

A terrain feature easily identified on an aerial photograph and whose horizontal or vertical position or both have been determined by survey measurements. Picture points are marked on the aerial photographs by the surveyor, and are used by the photomapper.

Planetable

A field device for plotting the lines of a survey directly from observations. It consists essentially of a drawing board mounted on a tripod, with a leveling device designed as part of the board and tripod.

Planimetric Feature

Item detailed on a planimetric map.

Plumb Line

The direction normal to the geopotential field. The continuous curve to which the gradient of gravity is everywhere tangential.

Positional Error

The amount by which the actual location of a cartographic feature fails to agree with the feature's true position.

Post-Processed Real-Time Kinematic GPS

GPS carrier phase positioning performed without real-time data link and solution.

Precision

The amount by which a measurement deviates from its mean.

Prime Meridian

The meridian of longitude 0° , used as the origin for measurement of longitude. The meridian of Greenwich, England, is almost universally used for this purpose.

Prime Vertical

The vertical circle through the east and west points of the horizon. It may be true, magnetic, compass or grid depending upon which east or west points are involved.

Project Control

Control used for a specific project.

Project Datum

Datum used for a specific project.

Projection

A set of functions, or the corresponding geometric constructions, relating points on one surface to points on another surface. A projection requires every point on the first surface to correspond one-to-one to points on the second surface.

Quadrangle

Consisting of four specified points and the lines or line segments on which they lie. The quadrangle and the quadrilateral differ in that the quadrangle is defined by four specified angle points, the quadrilateral by four specified lines or line-segments.

Random Error

Randomly distributed deviations from the mean value.

Range Pole

A simple rod fitted with a sharp-pointed, shoe of steel and usually painted alternately in red and white bands at 1-foot intervals.

EM 1110-1-1005
1 Jan 07

Readings

The observed value obtained by noting and/or recording scales.

Real-time

An event or measurement reported or recorded at the same time as the event is occurring through the absence of delay in getting, sending and receiving data.

Real-Time Kinematic GPS

GPS carrier phase processing and positioning in real-time.

Reciprocal Leveling

Measuring vertical angles or making rod readings from two instrument positions for the purpose of compensating for the effects of refraction.

Rectangular Coordinate Systems

Coordinates on any system in which the axes of reference intersect at right angles.

Redundant Measurements

Taking more measurements than are minimally required for a unique solution.

Reference Meridian, True

Based on the astronomical meridian.

Reference Meridian, Magnetic

Based on the magnetic pole.

Reference Point

Used as an origin from which measurements are taken or to which measurements are referred.

Refraction

The bending of rays by the substance through which the rays pass. The amount and direction of bending are determined by its refractive index.

Relative Accuracy

Indicated by the dimensions of the relative confidence ellipse between two points. A quantity expressing the effect of random errors on the location of one point or feature with respect to another.

Repeating Theodolite

Designed so that the sum of successive measurements of an angle can be read directly on the graduated horizontal circle.

Resection

Determining the location of a point by extending lines of known direction to two other known points.

Sexagesimal System

Notation by increments of 60. As the division of the circle into 360° , each degree into 60 minutes, and each minute into 60 seconds.

Set-up

In general, the situation in which a surveying instrument is in position at a point from which observations are made.

Spheroid

Used as a synonym for ellipsoid.

Spirit Level

A closed glass tube (vial) of circular cross section. Its center line forms a circular arc with precise form and filled with ether or liquid of low viscosity, with enough free space left for a bubble of air or gas.

Stadia Constant

The sum of the focal length of a telescope and the distance from the vertical axis of the instrument on which the telescope is mounted to the center of the objective lens-system.

Stadia Traverse

Distances are determined using a stadia rod. A stadia traverse is suited to regions of moderate relief with an adequate network of roads. If done carefully, such a traverse can establish elevations accurate enough for compiling maps with any contour interval now standard.

Standard Error

The standard deviation of the errors associated with physical measurements of an unknown quantity, or statistical estimates of an unknown quantity or of a random variable.

Systematic Error

Errors that affect the position (bias) of the mean. Systematic errors are due to unmodeled affects on the measurements that have a constant or systematic value.

State Plane Coordinate System (SPCS)

A planar reference coordinate system used in the United States.

Strength of Figure

A number relating the precision in positioning with the geometry with which measurements are made.

Subtense Bar

A bar with two marks at a fixed, known distance apart used for determining the horizontal distance from an observer by means of the measuring the angle subtended at the observer between the marks.

Taping

Measuring a distance on the using a surveyor's tape.

Three-wire Leveling

The scale on the leveling rod is read at each of the three lines and the average is used for the final result.

Topographic Map

A map showing the horizontal and vertical locations of the natural and man-made features represented and the projected elevations of the surroundings.

Transformation

Converting a position from one coordinate system to another.

Transit

The apparent passage of a star or other celestial body across a defined line of the celestial sphere.

EM 1110-1-1005
1 Jan 07

Transit Rule

The correction to be applied to the departure (or latitude) of any course has the same ratio to the total misclosure in departure (or latitude) as the departure (latitude) of the course has to the arithmetical sum of all the departures (latitudes) in the traverse. The transit rule is often used when it is believed that the misclosure is caused less by errors in the measured angles than by errors in the measured distances.

Transverse Mercator Projection

Mercator map projection calculated for a cylinder with axis in the equatorial plane.

Traverse

A sequence of points along which surveying measurements are made.

Triangulation

Determination of positions in a network by the measurement of angles between stations.

tribrach

The three-armed base, of a surveying instrument, in which the foot screws used in leveling the instrument are placed at the ends of the arms. Also called a leveling base or leveling head.

Trigonometric heighting

The trigonometric determination of differences of elevation from observed vertical angles and measured distances.

Trilateration

Determination of positions in a network by the measurement of distances between stations using the intersection of two or more distances to a point.

Universal Transverse Mercator

A worldwide metric military coordinate system.

US Coast & Geodetic Survey (USC&GS)

Now known as National Ocean Service (NOS).

US Survey Foot

The unit of length defined by 1200/3937 m

Variance-Covariance Matrix

A matrix whose elements along the main diagonal are called the variances of the corresponding variables; the elements off the main diagonal are called the covariances.

Vernier

An auxiliary scale used in reading a primary scale. The total length of a given number of divisions on a vernier is equal to the total length of one more or one less than the same number of divisions on the primary scaled.

VERTCON

Acronym for vertical datum conversion. VERTCON is the computer software that converts orthometric heights between NGVD 29 to NAVD 88.

Vertical Angle

An angle in a vertical plane either in elevation or depression from the horizontal.

Vertical Circle

A graduated scale mounted on an instrument used to measure vertical angles.

Vertical Datum

Any level surface used as a reference for elevations. Although a level surface is not a plane, the vertical datum is frequently referred to as the datum plane.

World Geodetic System of 1984

Adopted as the standard geodetic datum for GPS positioning. Based on the World Geodetic System reference ellipsoid.

Wye Level

Having the telescope and attached spirit level supported in wyes (Y's) in which it can be rotated about its longitudinal axis (collimation axis) and from which it can be lifted and reversed, end for end. Also called a Y-level and wye-type leveling instrument.

Zenith

The point above the instrument where an extension of a plumb (vertical) line at the observer's position intersects the celestial sphere.

Zenith Angle

Measured in a positive direction downwards from the observer's zenith to the observed target.

Zenith Distance

The complement of the altitude, the angular distance from the zenith of the celestial body measured along a vertical circle.